

033



Bone Surgery
Knochenchirurgie
Cirugía ósea
Chirurgie osseuse
Chirurgia ossea



Ø 20 mm
140 g



½

33-670-10 100 g
33-670-14 140 g
16,5 cm, 6½"

Ø 26 mm
320 g

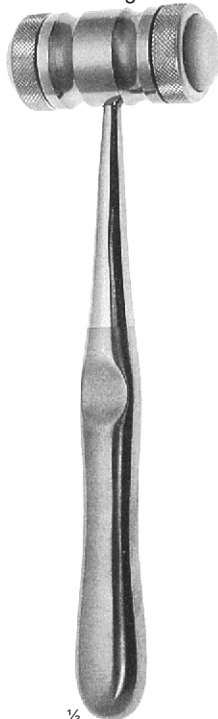

½

MEAD
33-672-17 185 g
17 cm, 6¾"

33-680-23
Ø 19 mm
230 g (8 oz)

33-680-26
Ø 25 mm
260 g (9 oz)

33-682-30
Ø 26 mm
300 g (10½ oz)

33-682-34
Ø 28 mm
340 g (12 oz)

33-682-40
Ø 30 mm
400 g (12 oz)

Ø 22 mm
165 g



½

33-676-19 165 g
19 cm, 7½"

Ø 30 mm
220 g

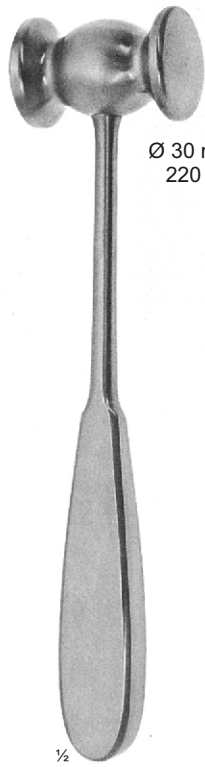

½

COLLIN
33-678-20 220 g
20 cm, 8"

½

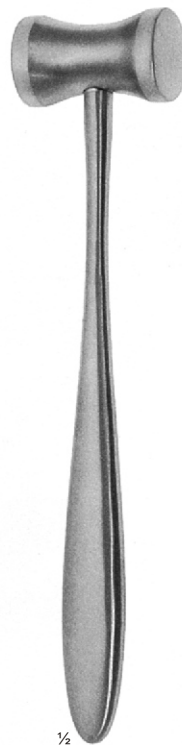

LUCAE
33-680-23
33-680-26
19 cm, 7½"

½

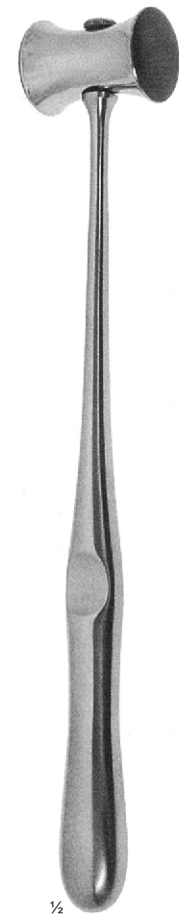

WILLIGER
33-682-30
33-682-40
24 cm, 9½"



ø 25 mm



GERZOG
 33-686-25
 19 cm, 7½"
 210 g

½

ø 27 mm



HAJEK
 33-690-27
 20 cm, 8"
 140 g

½

ø 40 mm



KIRIK
 33-688-40
 21 cm, 8¼"
 700 g

½

ø 20 mm



HAJEK
 33-692-20
 21,5 cm, 8½"
 110 g

½

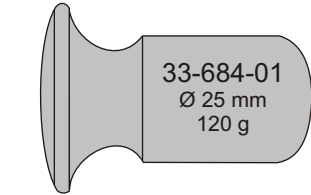

33-684-01
 Ø 25 mm
 120 g

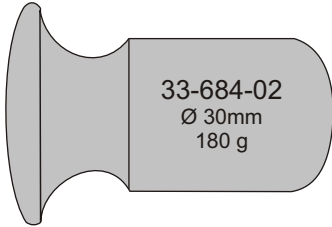

33-684-02
 Ø 30mm
 180 g

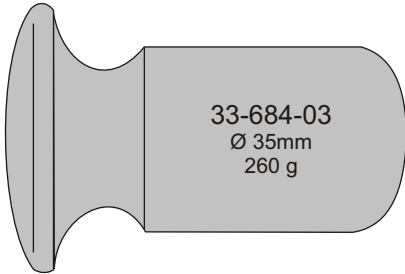

33-684-03
 Ø 35mm
 260 g



DOYEN
 33-684-01
 33-684-03
 21 cm, 8¼"

½

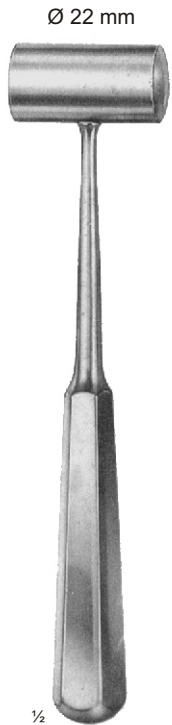

PARTSCH
 33-694-22
 18 cm, 7"
 200 g



VICKERS
 33-700-22
 19 cm 7¼"

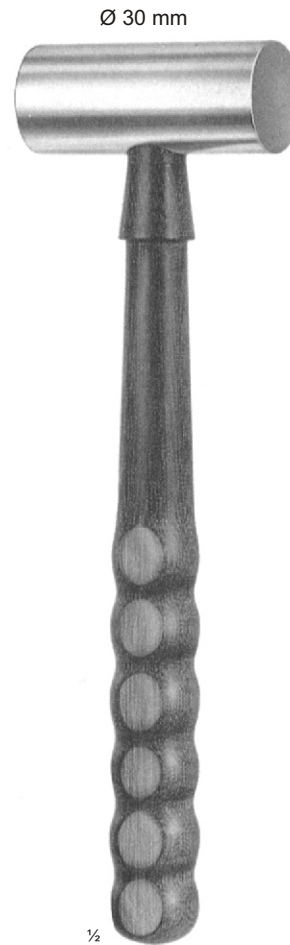

33-702-30
 24 cm, 9½"
 480 g



33-704-30
 26 cm 10½"
 510 g



33-706-00
 26 cm, 10½"
 450 g



33-708-01
 24 cm, 9½"
 390 g Ø 32 mm

33-708-02
 24 cm, 9½"
 540 g Ø 35 mm

33-708-03
 24 cm, 9½"
 740 g Ø 40 mm

Ø 42 mm Ø 30 mm



33-710-00
 26 cm, 10½"
 530 g

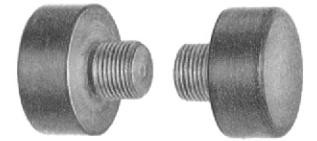

33-712-01

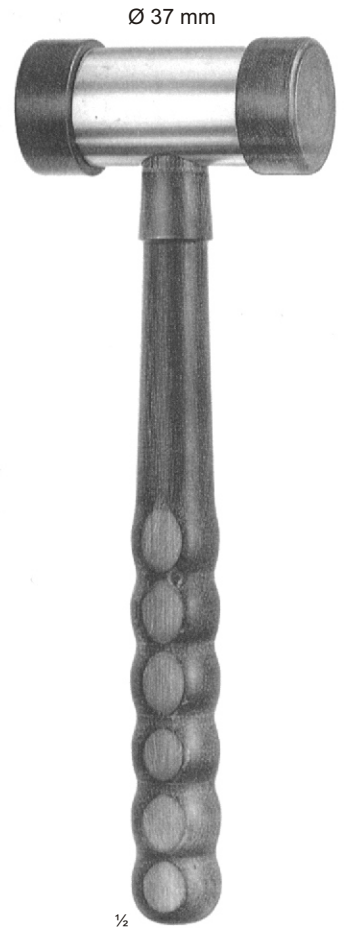

Ø 37 mm

33-712-37
 22,5 cm, 9"
 370 g



½

33-714-00
 26,5 cm, 10½"



½

33-716-00
 25 cm, 10"
 215 g Ø 30 mm

With interchangeable plastic disk
 Mit auswechselbaren Kunststoffbacken
 Con tapas de plástico intercambiables
 Avec masse plastique interchangeable
 Con piastre di plastica intercambiabili



½

33-718-00
 26,5 cm, 10½"
 900 g



Ø 30 mm

½

33-720-30
 18 cm, 7"
 125 g



Ø 42 mm

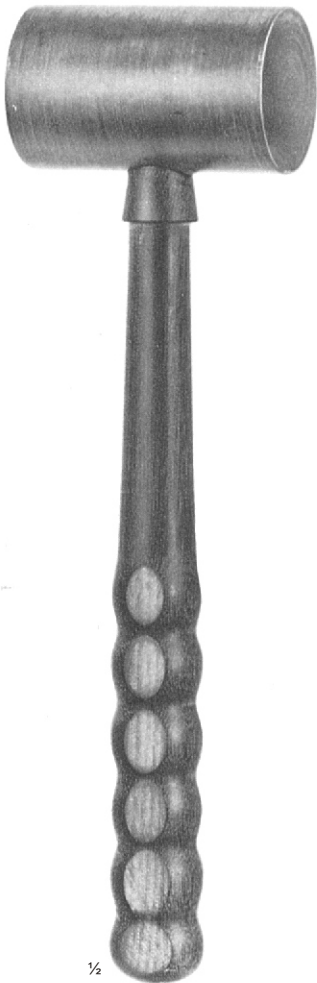

½

33-722-00 250 g
33-722-01 400 g
26 cm 10¼"

Ø 42 mm

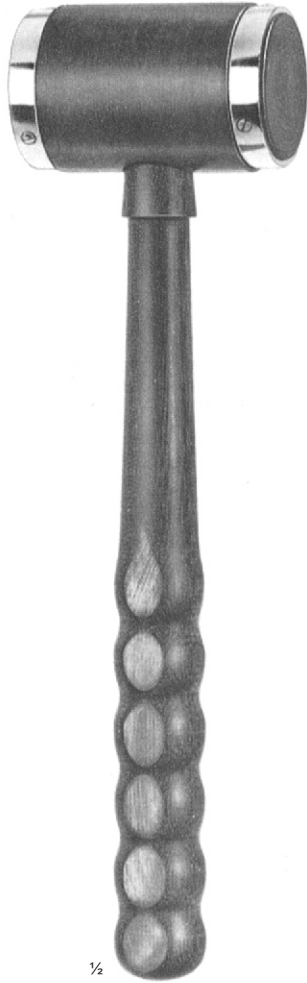

½

33-724-25
26 cm 10¼"
250 g

Ø 25 mm

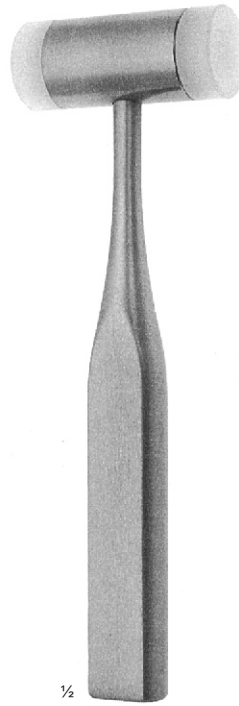

½

33-730-25
18,5 cm, 7¼"
140 g

With interchangeable plastic disk
Mit auswechselbaren Kunststoffbacken
Con tapas de plástico intercambiables
Avec masse plastique interchangeable
Con piastrine di plastica intercambiabili

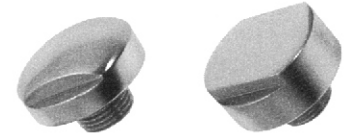

33-620-01

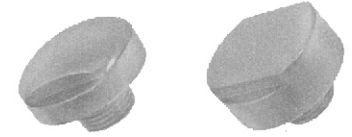

33-620-02



33-620-03

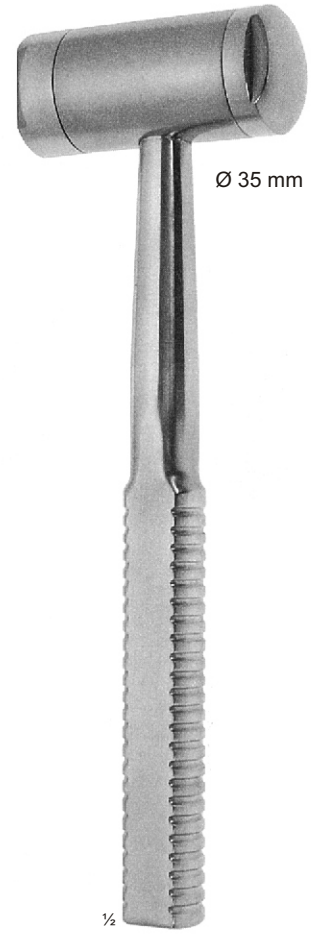

Ø 35 mm

½

WAGNER
33-732-00 170 g
33-732-01 260 g
23,5 cm, 9¼"

With interchangeable plastic disk
Mit auswechselbaren Kunststoffbacken
Con tapas de plástico intercambiables
Avec masse plastique interchangeable
Con piastrine di plastica intercambiabili



Ø 30 mm

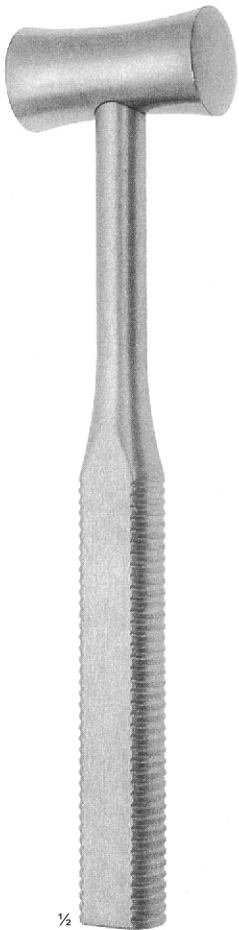

½

BERGMANN
33-734-30
23,5 cm, 9¼"
300 g

Ø 45 mm

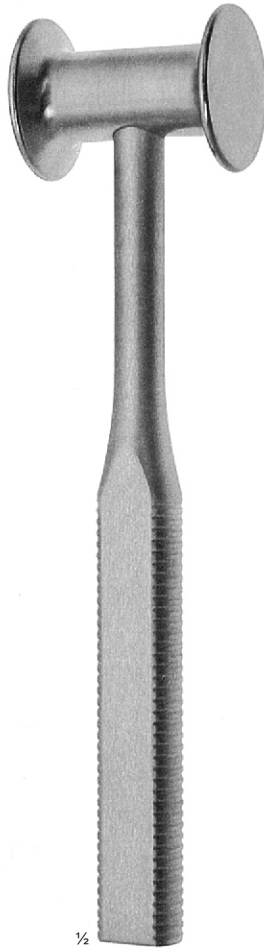

½

BERGMANN
33-736-45
25 cm, 10"
300 g

Ø 29/42 mm

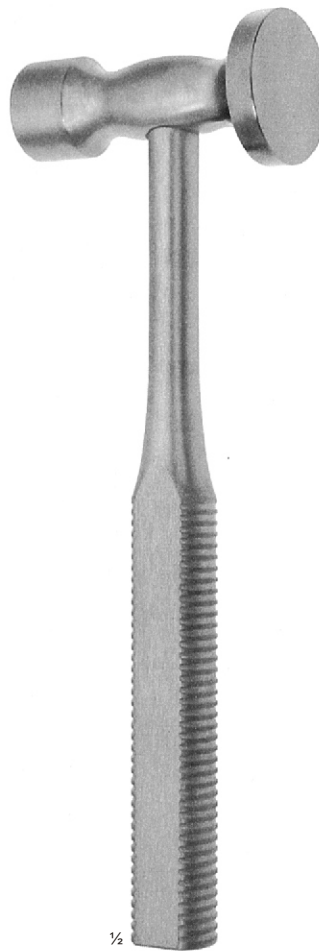

½

BERGMANN
33-738-00
25 cm, 10"
300 g

Ø 40 mm

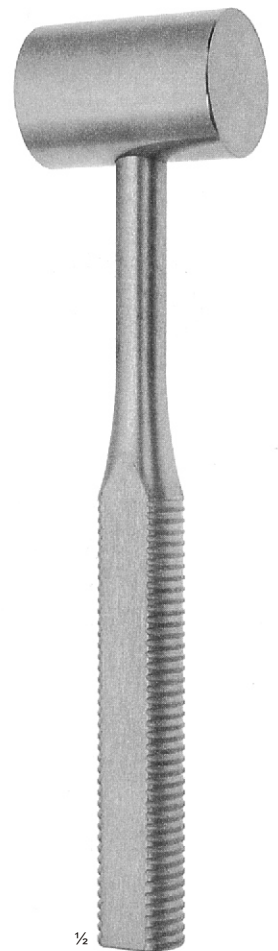

½

OMBREDANNE
33-740-40
25 cm, 10"
550 g



Meniscus Knives

Meniskusmesser
Bisturies para menisco
Bistouris à ménisque
Bisturi pe menisco

Retractors for knee

Wund-und Meniskushaken
Separadores para rodilla
Ecarteurs pour genou
Retrattori per ginocchio

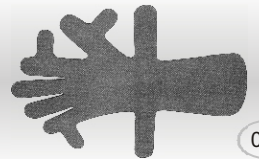

033

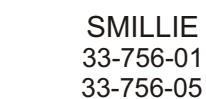
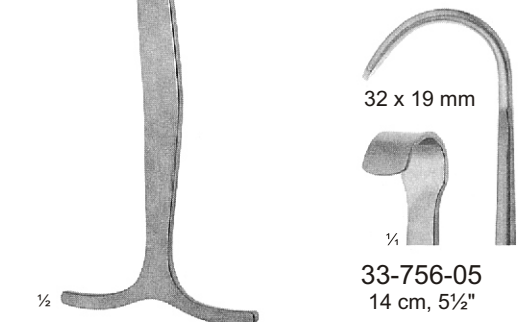
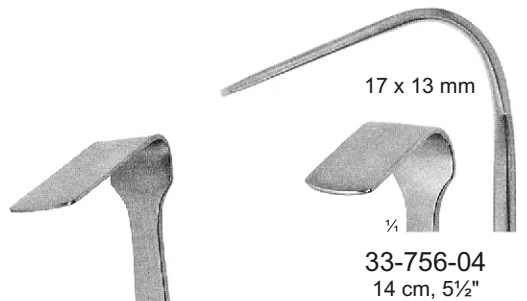
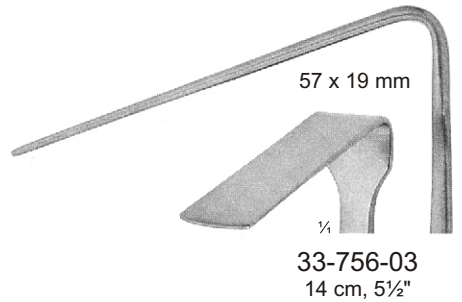
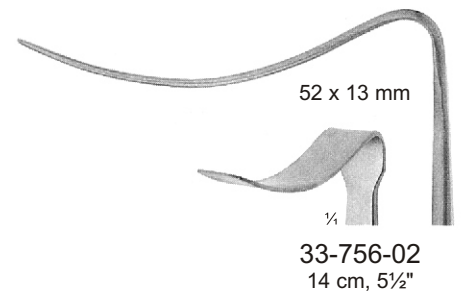
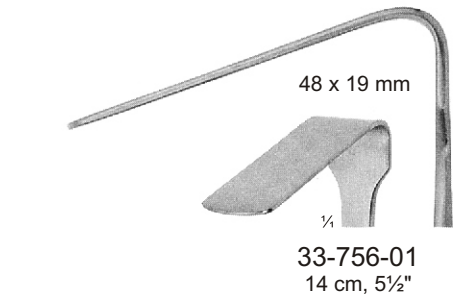
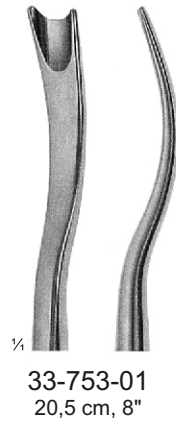
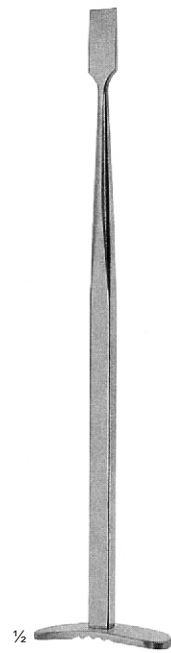
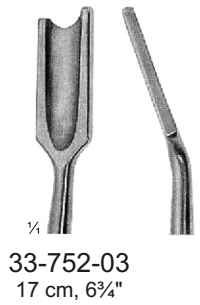
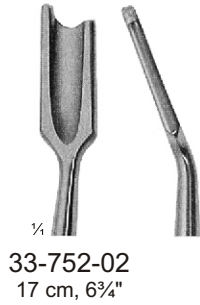
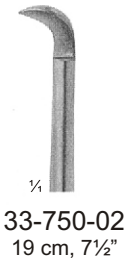

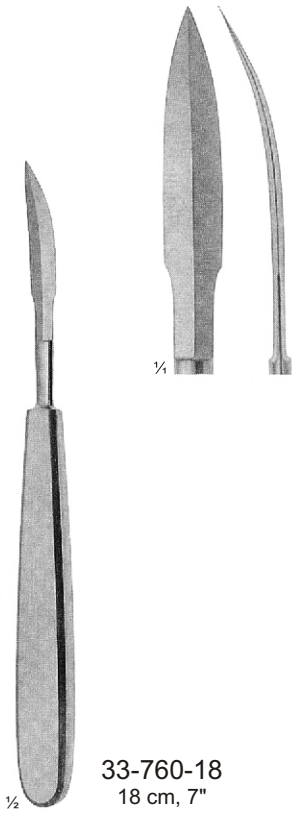
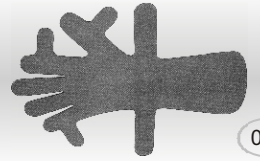

33-760-18
18 cm, 7"

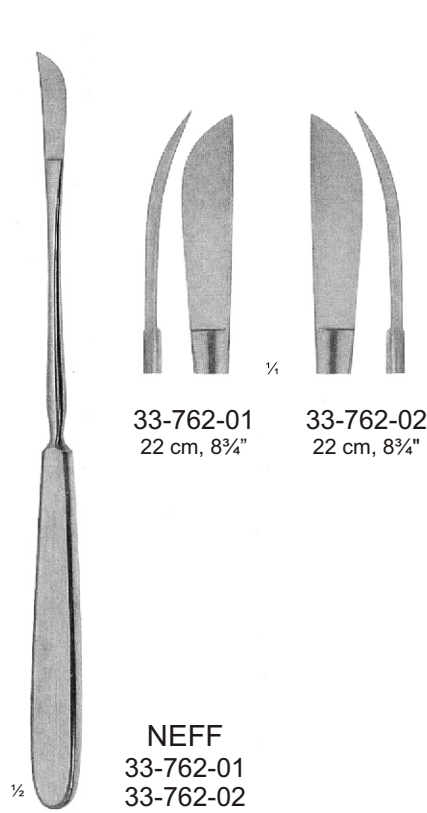

33-762-01
22 cm, 8 3/4"

33-762-02
22 cm, 8 3/4"

NEFF
33-762-01
33-762-02

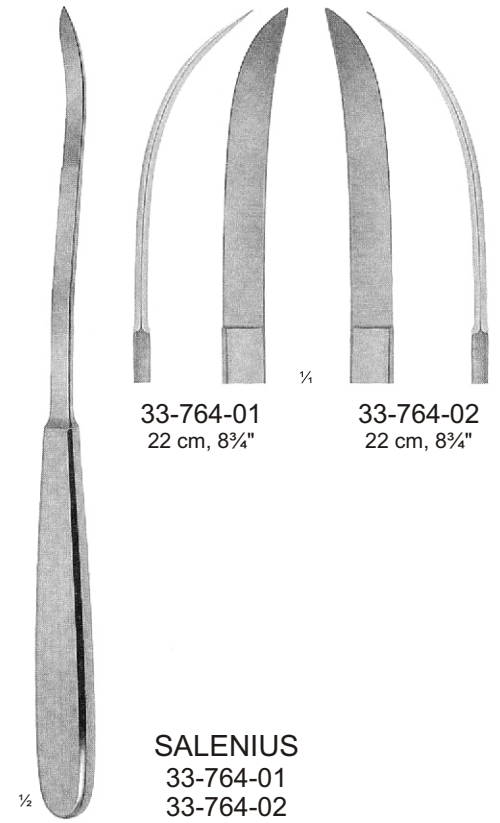

33-764-01
22 cm, 8 3/4"

33-764-02
22 cm, 8 3/4"

SALENIUS
33-764-01
33-764-02



VICKERS
33-765-24 25 cm, 10"
33-765-37 37 cm, 14 1/2"



VICKERS
33-767-25
25 cm, 10"

Tendon Passing Instruments

Sehnenführer
 Conductor de tendones
 Conducteurs à tendons
 Guida per tendine

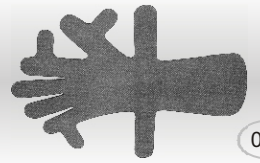
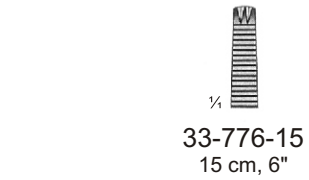
¼
 33-776-15
 15 cm, 6"

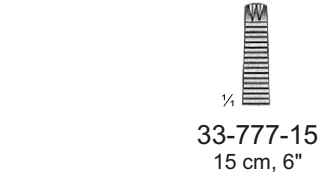

¼
 33-777-15
 15 cm, 6"

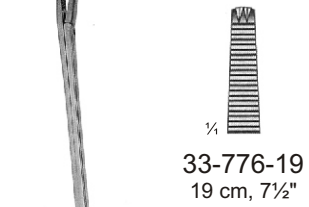

¼
 33-776-19
 19 cm, 7½"

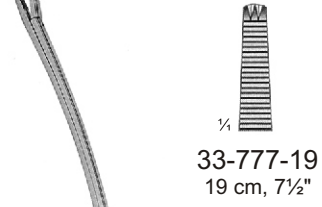

¼
 33-777-19
 19 cm, 7½"

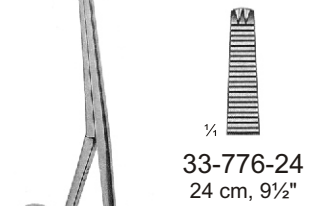

¼
 33-776-24
 24 cm, 9½"

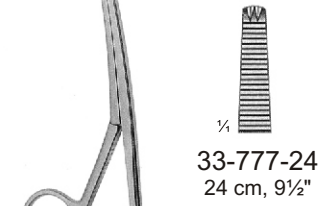

¼
 33-777-24
 24 cm, 9½"

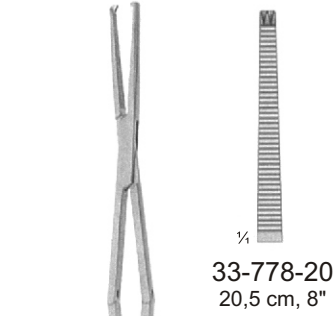

¼
 33-778-20
 20,5 cm, 8"



¼
 33-789-20
 20,5 cm, 8"



¼



BRAND
 33-776-15
 33-776-24



BRAND
 33-777-15
 33-777-24



33-778-20
 33-789-20



KLEINERT-KUTZ
 33-781-20
 20 cm, 8"

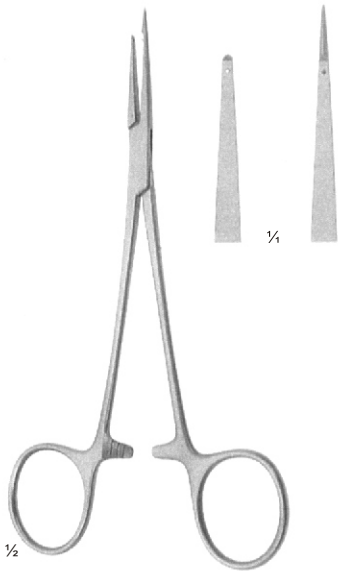

33-782-15
 15 cm, 6"

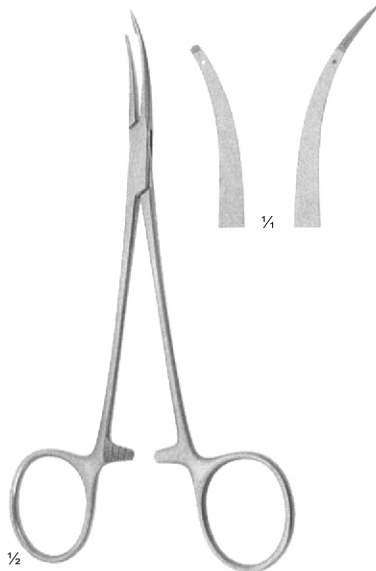

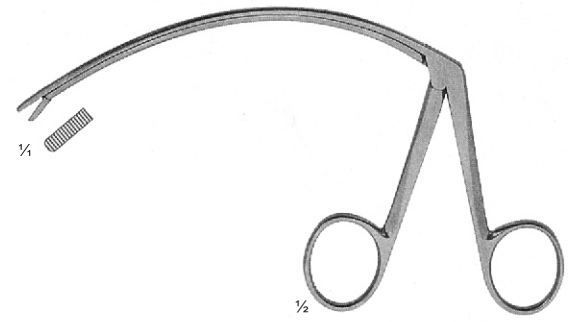

33-783-15
 15 cm, 6"



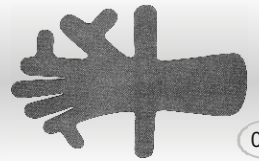

Working length: 11 cm, 4¾"
 Nutzlänge: 11 cm, 4¾"
 Longitud útil: 11 cm, 4¾"
 Longueur utile: 11 cm, 4¾"
 Lunghezza di lavoro: 11 cm, 4¾"

CARROLL
 33-785-11
 11 cm, 9"





 1/4
33-776-15
 15 cm, 6"



 1/4
33-777-15
 15 cm, 6"



 1/4
33-776-19
 19 cm, 7 1/2"

 1/4
33-777-19
 19 cm, 7 1/2"



 1/4
33-776-24
 24 cm, 9 1/2"

 1/4
33-777-24
 24 cm, 9 1/2"

 1/4
33-778-20
 20,5 cm, 8"

 1/4
33-789-20
 20,5 cm, 8"

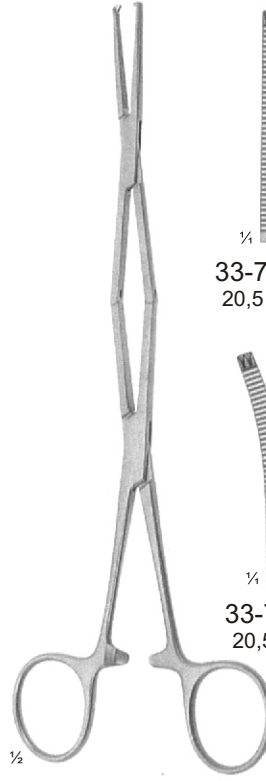
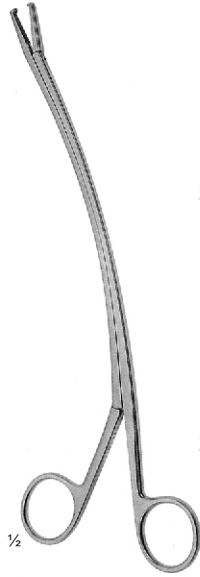
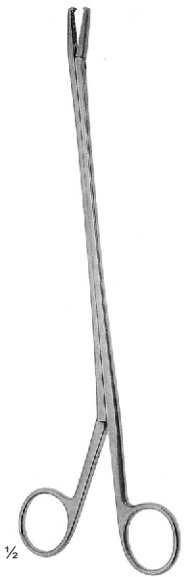
 1/4



BRAND
 33-776-15
 33-776-24

BRAND
 33-777-15
 33-777-24

33-778-20
 33-789-20

KLEINERT-KUTZ
 33-781-20
 20 cm, 8"

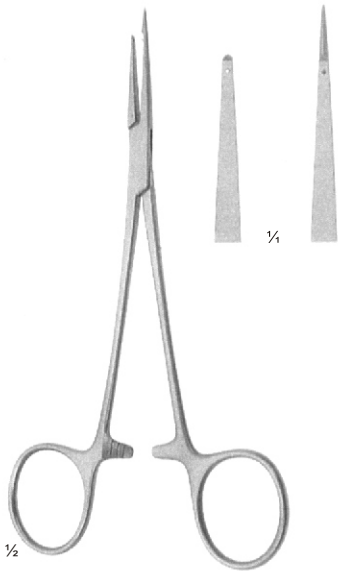

33-782-15
 15 cm, 6"

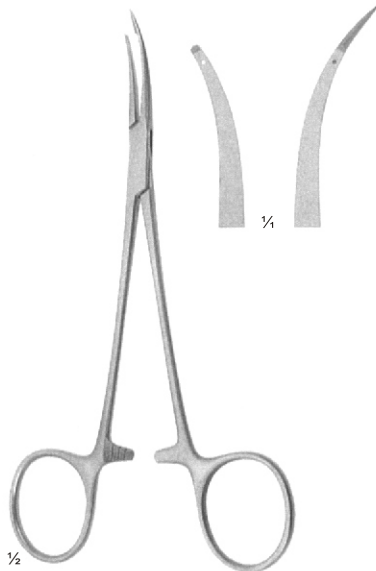

33-783-15
 15 cm, 6"

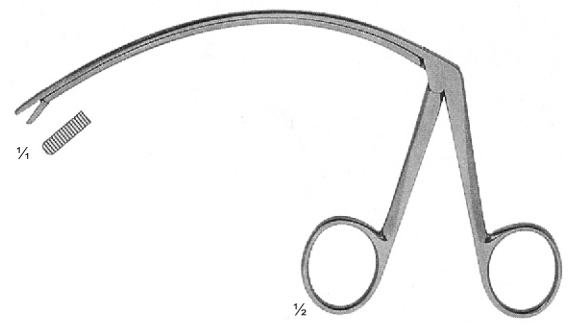

Working length: 11 cm, 4 3/8"
 Nutzlänge: 11 cm, 4 3/8"
 Longitud útil: 11 cm, 4 3/8"
 Longueur utile: 11 cm, 4 3/8"
 Lunghezza di lavoro: 11 cm, 4 3/8"

CARROLL
 33-785-11
 11 cm, 9"



33-790-14
 14 cm, 5½"



33-791-13
 13,5 cm, 5¼"

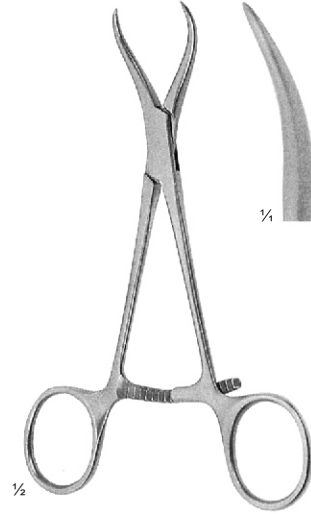

33-792-13
 13,5 cm, 5¼"

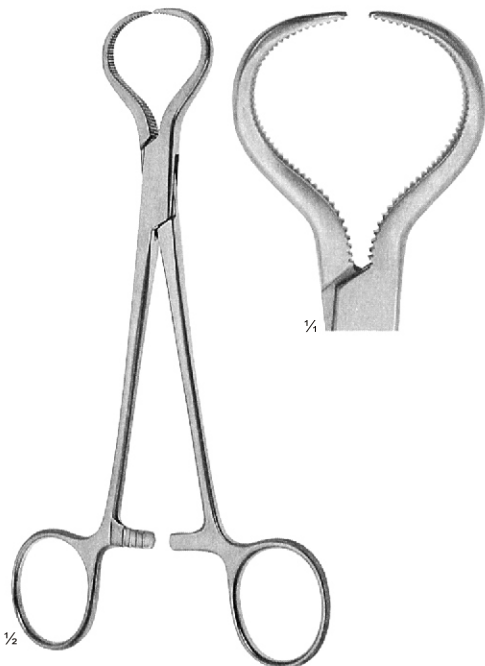

LEWIN
 33-794-17
 17,5 cm, 7"

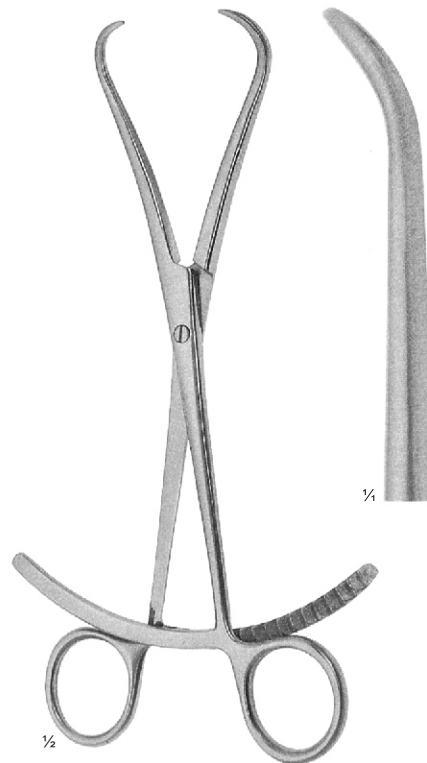

33-796-20
 20 cm, 8"

Meniscus and Cartilage Grasping Forceps

Meniskus- und Knorpelfaßzangen

Pinzas para menisco y cartilago

Pinces à ménisque et cartilage

Pinze da presa per menisco e cartillagine

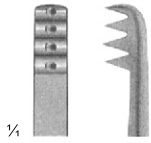
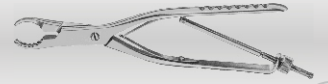

33-798-16
16,5 cm, 6½"

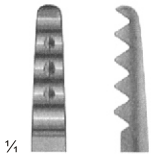

33-798-19
19 cm, 7½"

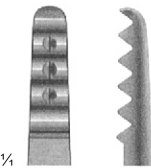

33-798-20
20 cm, 8"

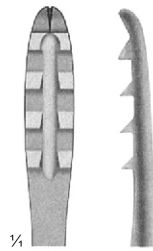

33-800-20
20 cm, 8"

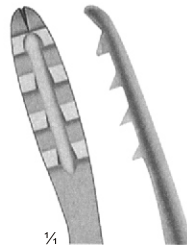

33-801-20
20 cm, 8"

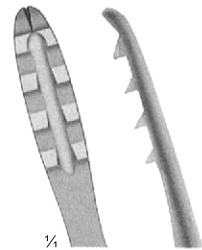

MARTIN
33-798-16
33-798-20



BIRCHER-GANSKE
33-800-20
33-801-20



BIRCHER-GANSKE
33-803-20
20 cm, 8"

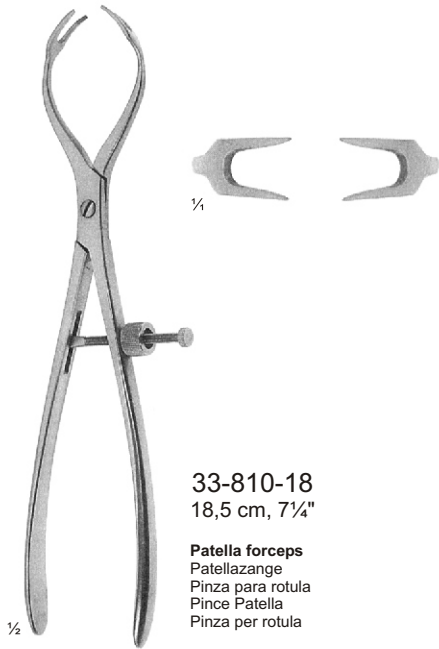
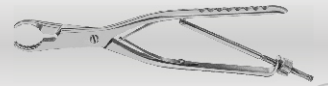

33-810-18
 18,5 cm, 7 1/4"

Patella forceps
 Patellazange
 Pinza para rotula
 Pince Patella
 Pinza per rotula

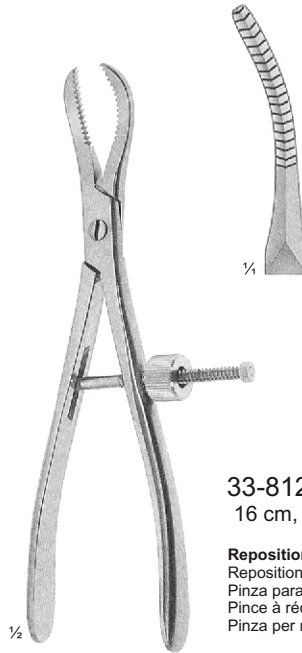

33-812-16
 16 cm, 6 1/4"

Reposition forceps
 Repositionszange
 Pinza para reducción
 Pince à réduction
 Pinza per riposizioni

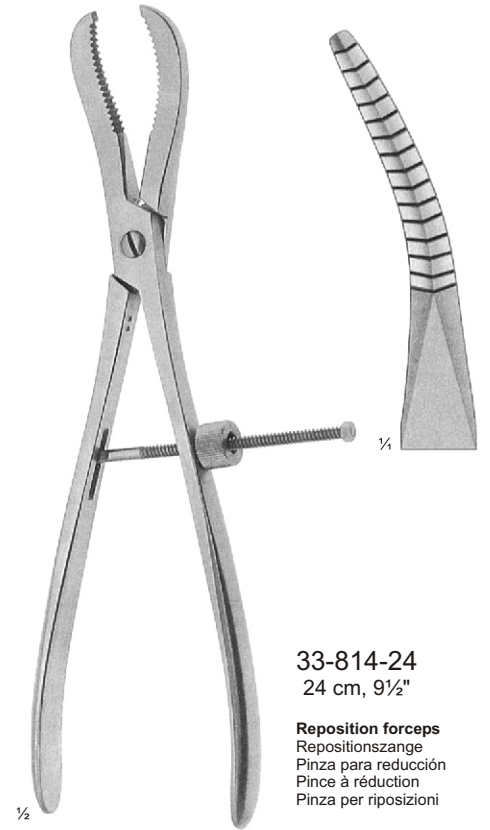

33-814-24
 24 cm, 9 1/2"

Reposition forceps
 Repositionszange
 Pinza para reducción
 Pince à réduction
 Pinza per riposizioni

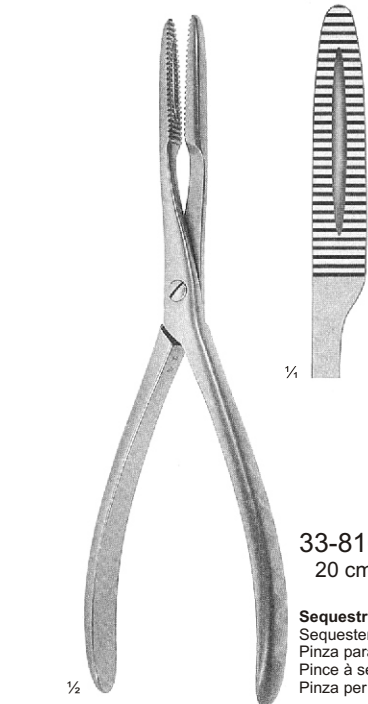

33-816-20
 20 cm, 8"

Sequester forceps
 Sequesterzange
 Pinza para secuestro
 Pince à séquestre
 Pinza per frammento osseo



33-817-20
 20 cm, 8"

Sequester forceps
 Sequesterzange
 Pinza para secuestro
 Pince à séquestre
 Pinza per frammento osseo

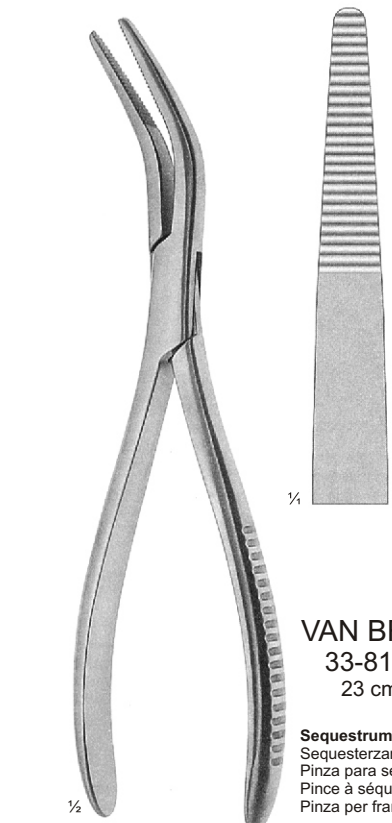

VAN BRUEN
33-819-23
 23 cm, 9"

Sequester forceps
 Sequesterzange
 Pinza para secuestro
 Pince à séquestre
 Pinza per frammento osseo

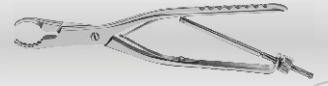

33-820-20
 20 cm, 8"

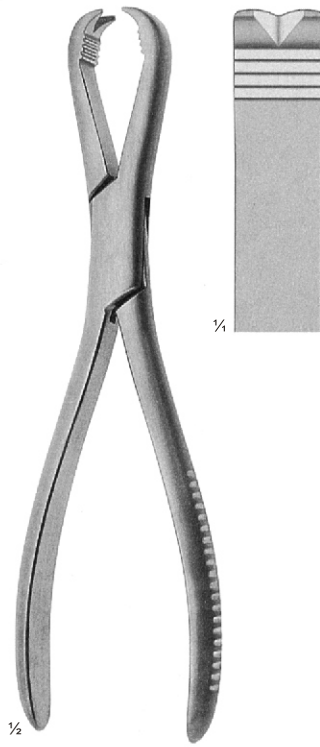

LANGENBECK
33-822-21
 21 cm, 8 1/4"

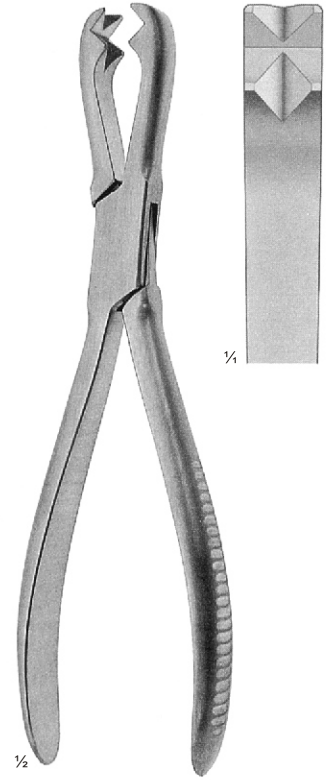

FERGUSSON
33-824-20
 20 cm, 8 1/4"

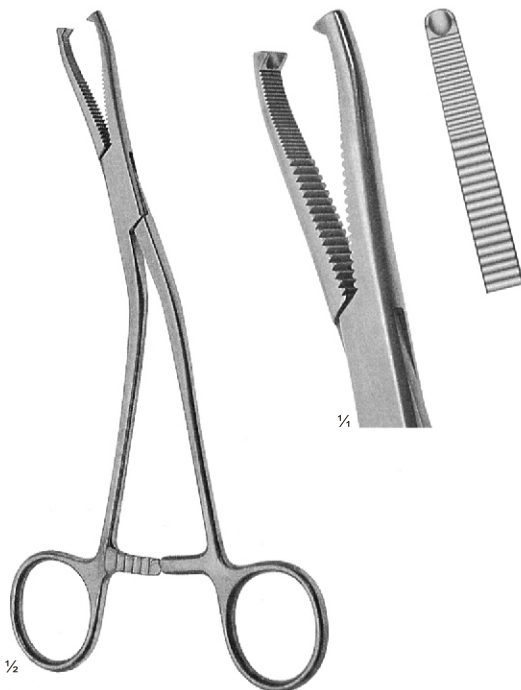

DINGMANN
33-825-19
 19 cm, 7 1/2"

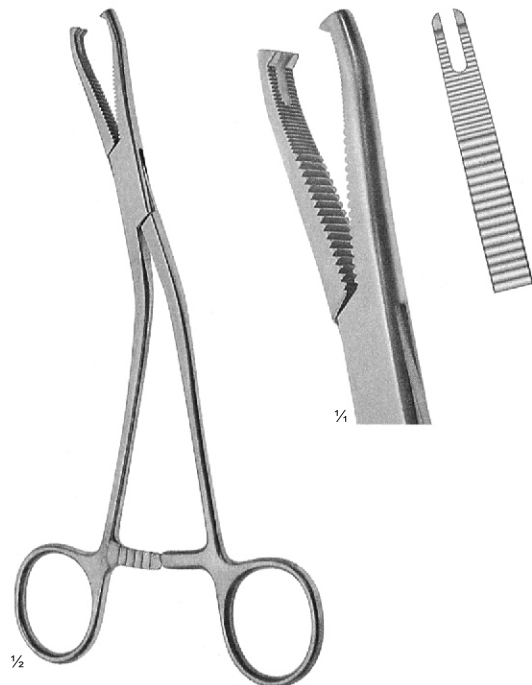

DINGMANN
33-827-18
 18,5 cm, 7 1/4"

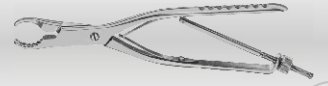

SEM B
 33-839-19
 19 cm, 7½"

Rib and bone holding forceps
 Rippen- und Knochenfaßzange
 Pinza para huesos
 Daviers à os
 Pinza per ossa e costole



SEM B
 33-841-19 19 cm, 7¾"
 33-850-17 17 cm, 6¾"
 33-850-23 23 cm, 9"

Rib and bone holding forceps
 Rippen- und Knochenfaßzange
 Pinza para huesos
 Daviers à os
 Pinza per ossa e costole



FARABEU F
 33-860-23 23 cm, 9"
 33-860-26 26 cm, 10¼"

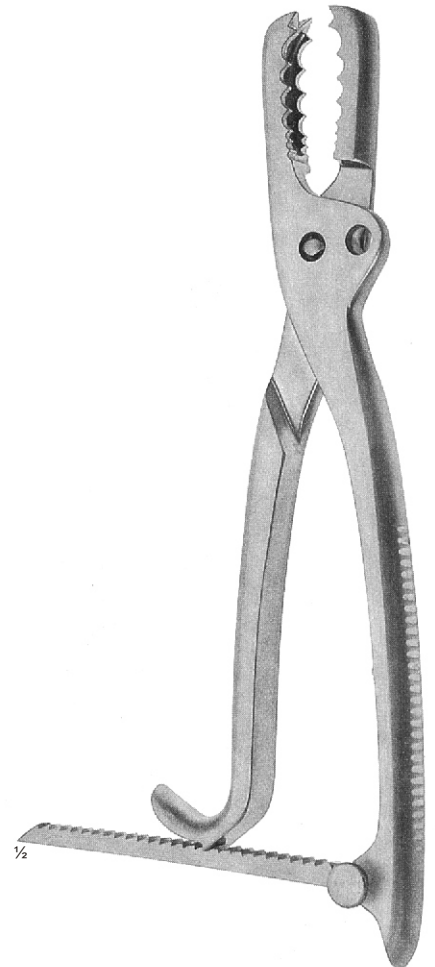

FARABEU-F LAMBOTTE
 33-707-26
 26 cm, 10¼"

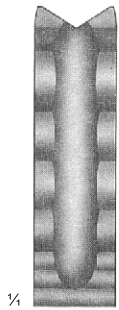

¼

½

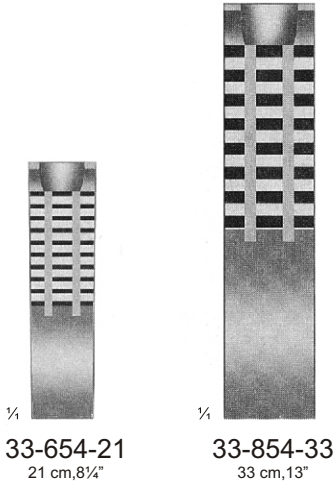
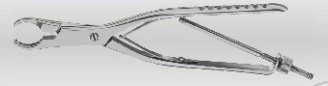

33-654-21
21 cm, 8 1/4"

33-854-33
33 cm, 13"



33-856-17
17 cm, 6 3/4"

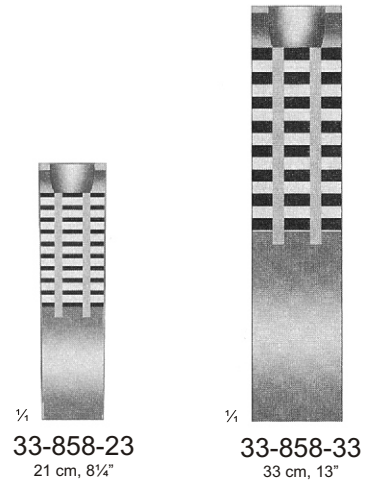

33-858-23
21 cm, 8 1/4"

33-858-33
33 cm, 13"

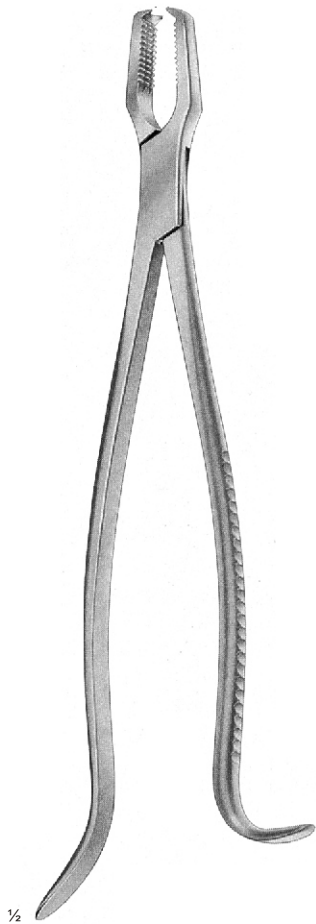

KERN-LANE
33-854-21
33-854-33

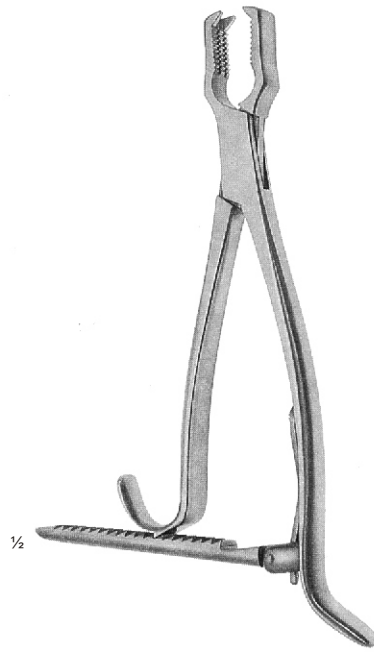

KERN-MINI
33-858-17



KERN
33-858-23
33-858-33

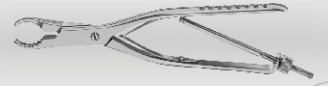

LAMBOTTE
 33-866-22 22 cm, 8¾"
 33-866-27 27 cm, 8½"
 33-866-30 30 cm, 12"



LAMBOTTE
 33-868-22
 33-868-33

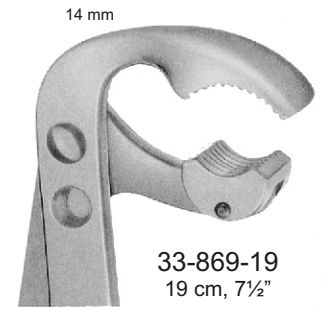
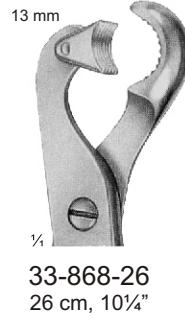

LAMBOTTE
 33-869-19
 33-869-26

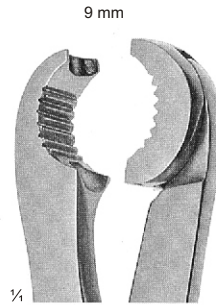
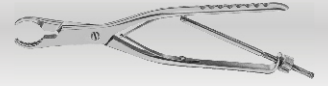

33-870-22
 22 cm, 8¾"

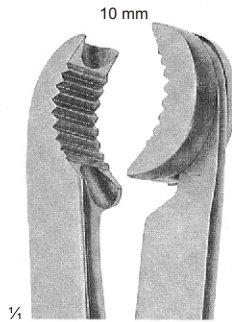

33-870-27
 27 cm, 10½"

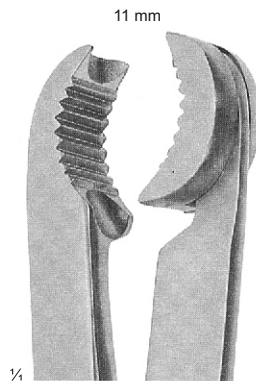

33-870-30
 30 cm, 12"



LAMBOTTE
 33-870-22
 33-870-30

Adjustable, 1 jaw swiveled
 Verstellbar, 1Maulteil beweglich
 Ajustavble, 1 mandibula movible
 à crémaillère, 1 more mobile
 Regolabili, 1 mandibola mobile

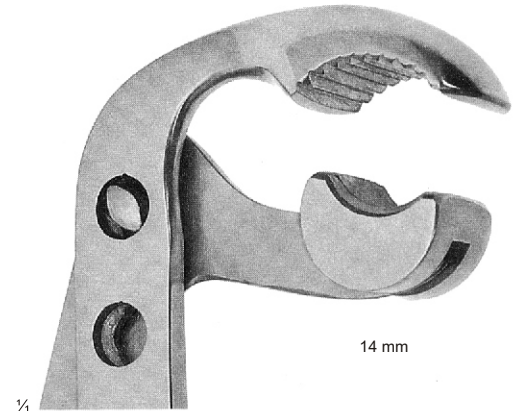

14 mm



LAMBOTTE
 33-871-21
 21 cm, 8¾"

Adjustable, 1 jaw swiveled
 Verstellbar, 1Maulteil beweglich
 Ajustavble, 1 mandibula movible
 à crémaillère, 1 more mobile
 Regolabili, 1 mandibola mobile

Bone Holding Forceps

Knochenhalte­zangen
Pinzas para hesos
Daviers
Tenaglie per ossa

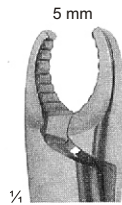
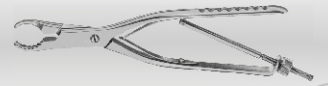

33-872-18
33-872-18
18 cm, 7"

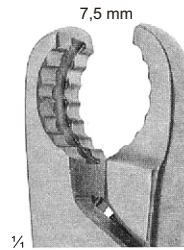

33-872-23
33-872-23
23 cm, 9"

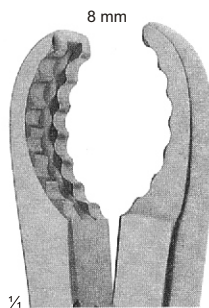

33-872-25
33-872-25
25 cm, 10"

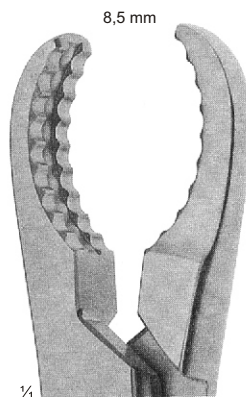

33-872-28
33-872-28
28 cm, 11"



ULRICH
33-872-18
33-872-28



ULRICH
33-873-28
33-873-28

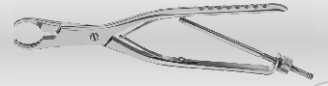

VERBRUGGE
 33-875-17
 33-875-27

With lip joint
 Mit Lappenverschlus
 Con cierre de labio
 Avec fermeture à lambeaux
 Con chiusura a tela



5 mm

¼

33-875-17
 17,5 cm, 6¾"



10.5 mm

¼

33-875-26
 26 cm, 10½"



9,5 mm

¼

33-875-25
 25 cm, 10"



12 mm

¼

33-875-27
 27 cm, 11"

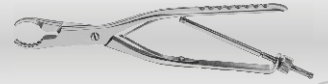

2,5 mm



¼

33-877-15
 15 cm, 6"

10 mm



¼

33-877-26
 26 cm, 10¼"

6,5 mm



¼

33-877-19
 19 cm, 7½"

11 mm

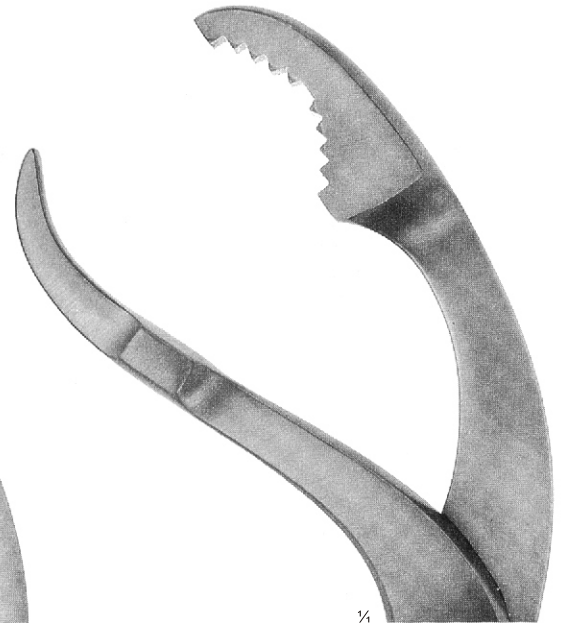

¼

33-877-28
 28 cm, 11"

9,5 mm

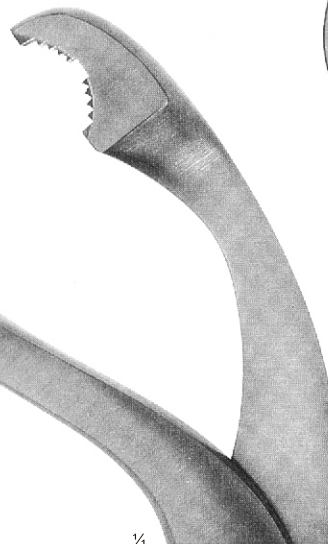

¼

33-877-24
 24 cm, 9½"



½

33-877-15
33-877-28

Self-centering forceps with thread fixation
 Selbstzentriert mit Gewindeperr
 Autocentrante con cremallera de tuerca
 Autostatique, à crémaillère
 Pinze autocentranti con blocco di filettatura

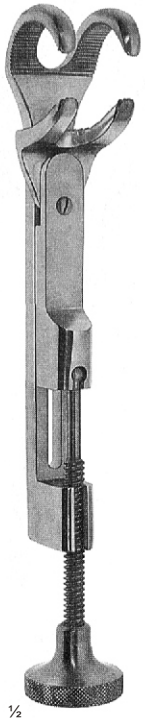

½

LOWMANN HOGLUND

35-880-19
19 cm, 7½"

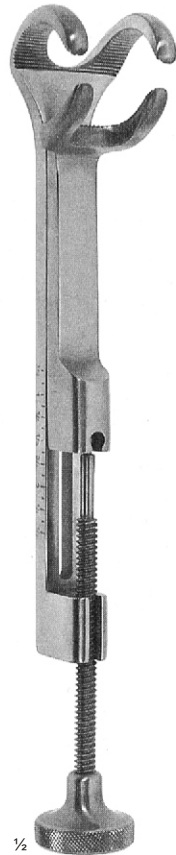

½

LOWMANN-LAMBERT

35-890-18
18 cm, 7"
35-890-20
20 cm, 8"
35-890-22
22 cm, 8¾"

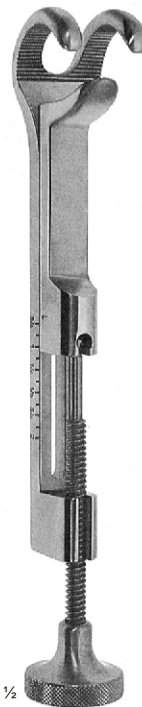

½

GERSTER LOWMANN

35-891-18
18 cm, 7"
35-891-20
20 cm, 8"
35-891-22
22 cm, 8¾"



½

GERSTER
35-892-00

Traction bar for bone clamps
Distractionsklammer für Knochen-
halteklammern
Barra de tracolón para pinzas
porta-huesos
Tracteur pour daviers
Barra di trazione per tenaglie
per ossa

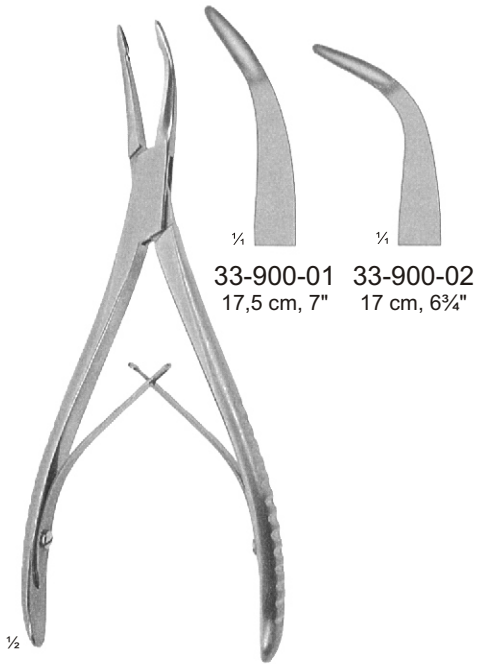
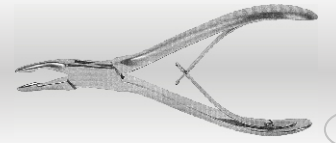

33-900-01 33-900-02
 17,5 cm, 7" 17 cm, 6¾"

STELLBRINK
 33-900-01
 33-900-02

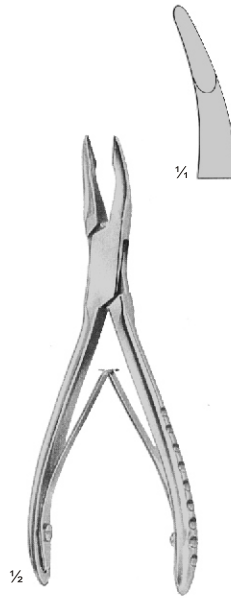

**MINI
 FRIEDMAN**
 33-901-12
 12 cm, 5"

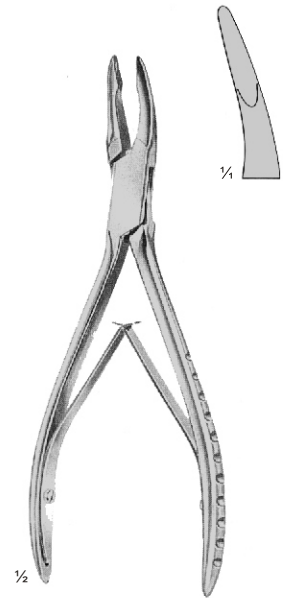

FRIEDMAN
 33-902-14
 14 cm, 5½"

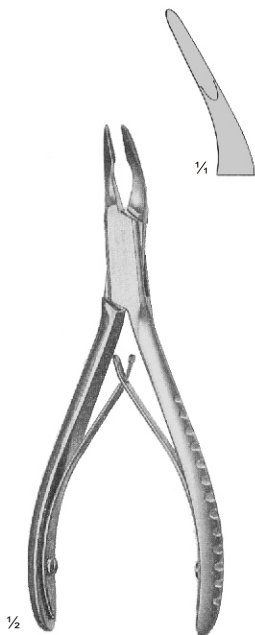

**FRIEDMAN
 VICKERS**
 33-904-14
 14 cm, 5½"

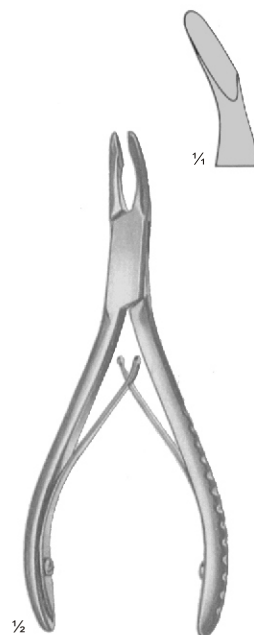

CLEVELAND
 33-906-14
 14 cm, 5½"

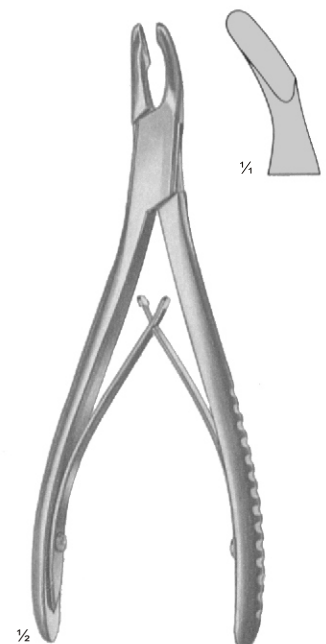

CLEVELAND
 33-908-17
 17 cm, 6¾"

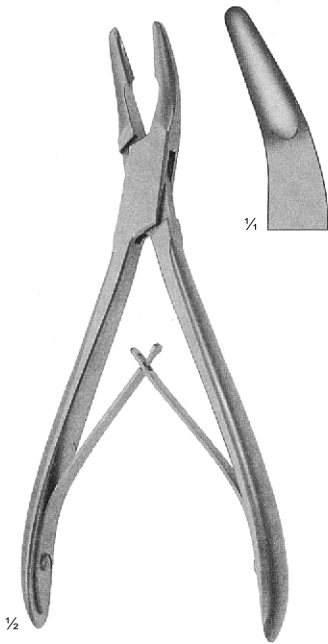
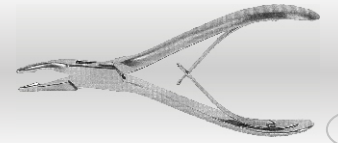

MEAD
 33-910-16
 16,5 cm, 6½"

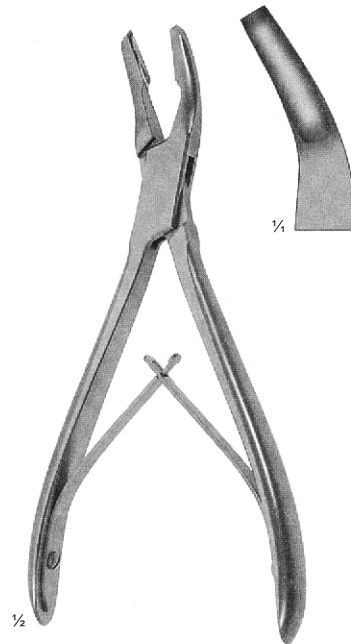

MEAD
 33-912-16
 16,5 cm, 6½"

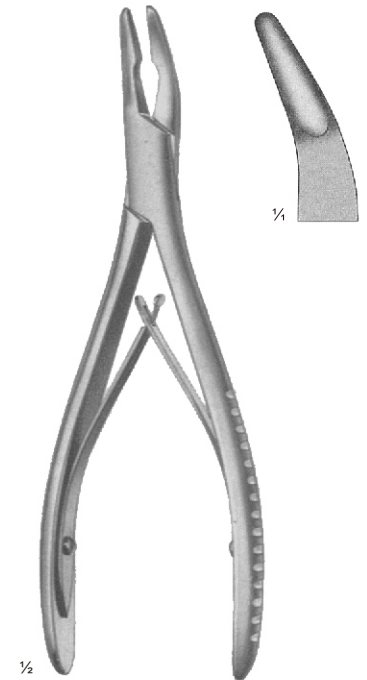

HARTMANN
 33-914-18
 18,5 cm, 7¼"



33-916-01 **33-916-02**
 18 cm, 7" 18 cm, 7"

JANSEN
 33-916-01
 33-916-02

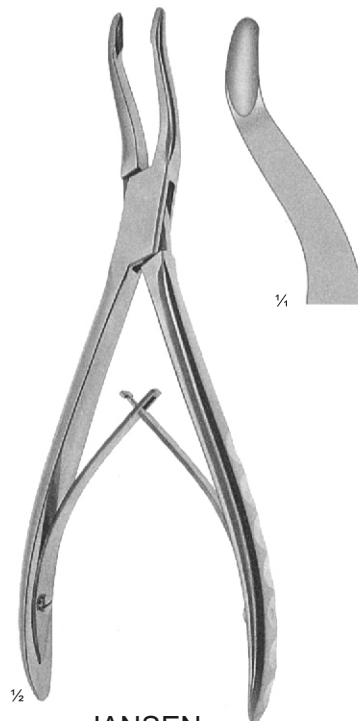

JANSEN
 33-917-19
 19 cm, 7½"

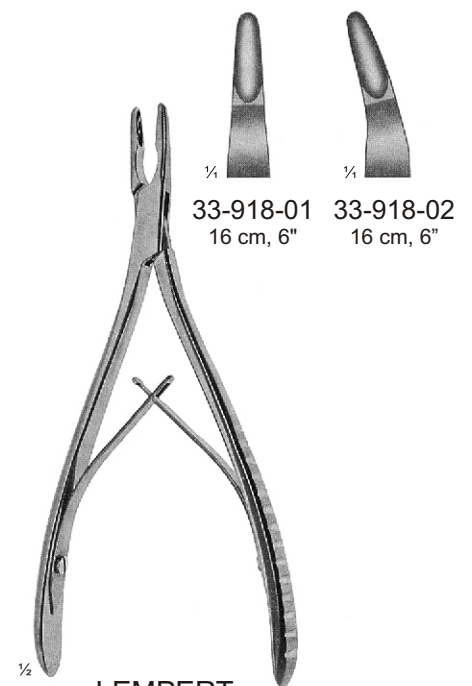

33-918-01 **33-918-02**
 16 cm, 6" 16 cm, 6"

LEMPERT
 33-918-01
 33-918-02

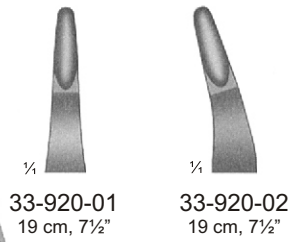
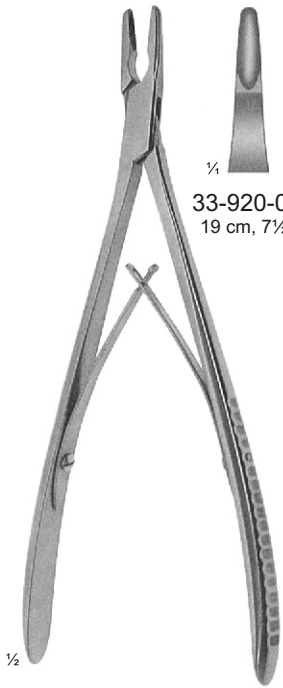
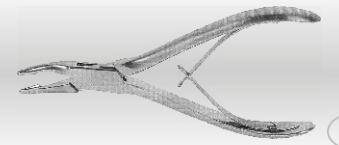

LEMPERT
 33-920-01
 33-920-02

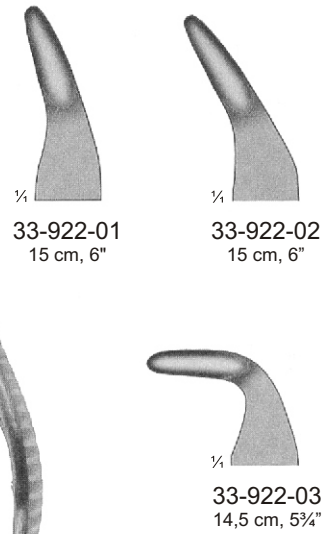
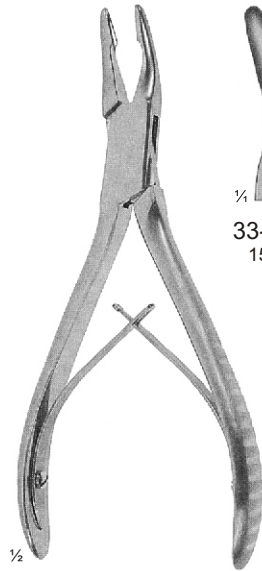

BLUMENTHAL
 33-922-01
 33-922-03

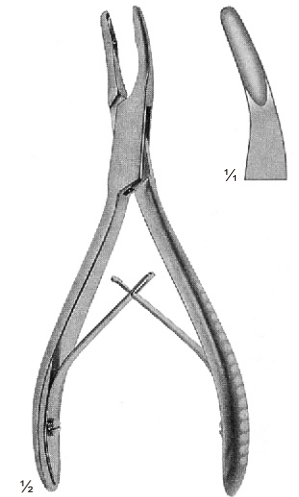

LUER FRIEDMAN
 33-924-15
 15 cm, 6"

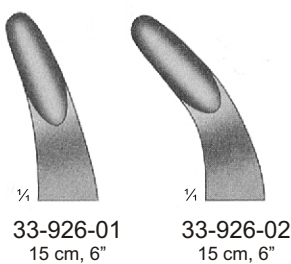
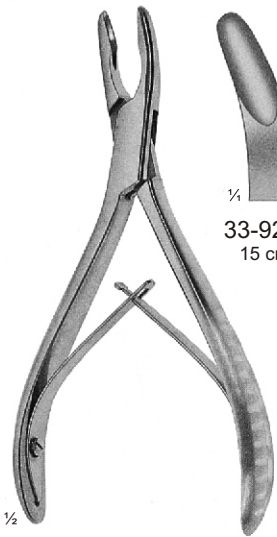

LUER
 33-926-01
 33-926-02
 15 cm, 6"

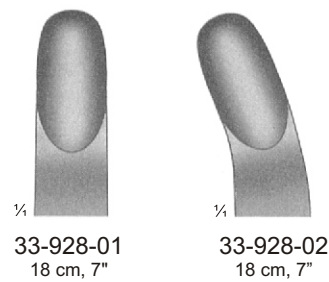

RUSKIN
 33-928-01
 33-928-02

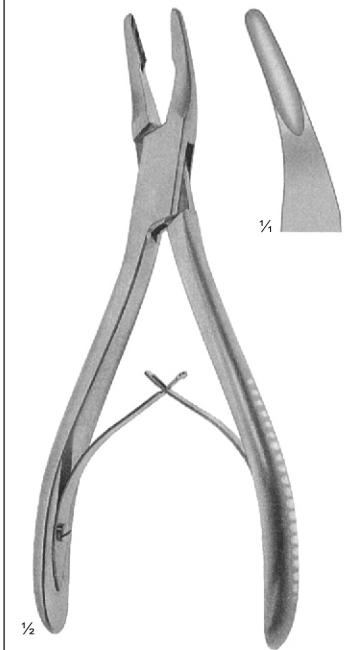

BEYER
 33-930-18
 18 cm, 7"

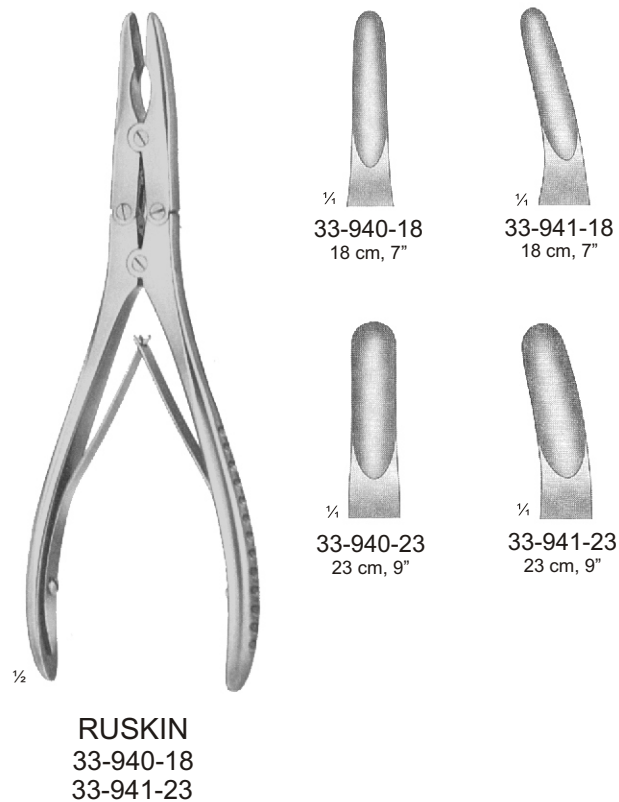
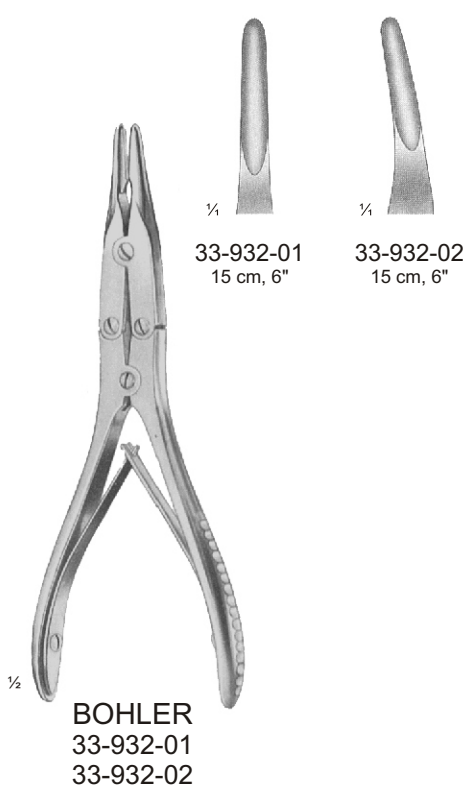

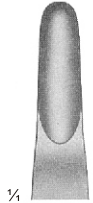

¼



¼

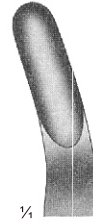

¼

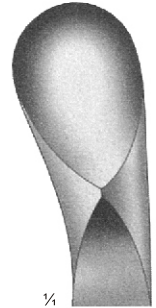

¼



½

STILLE
33-943-23
23 cm, 9"

Laterally curved
Seitwärts gebogen
Curvas lateral
Courbure latérale
Curva lateralmente



½

STILLE-RUSKIN
33-944-23
23 cm, 9"

Laterally curved
Seitwärts gebogen
Curvas lateral
Courbure latérale
Curva lateralmente

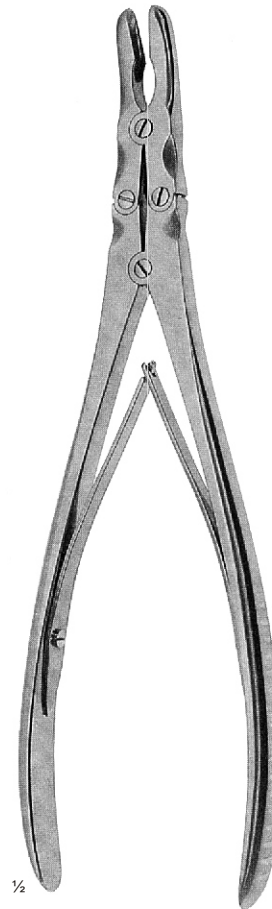

½

RUSKIN
33-946-23
23 cm, 9"



½

SEMB
31-126-22
22 cm, 9"



Bone Rongeurs
 Hohlmeißelzangen
 Pinzas-gubias
 Pincas-gouges
 Pinze per ossa



033



33-950-01
24 cm, 9½"

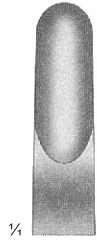

33-950-02
24 cm, 9½"

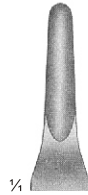

33-951-01
24 cm, 9½"



33-951-02
24 cm, 9½"

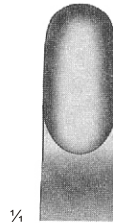

33-952-22
22 cm, 8¾"

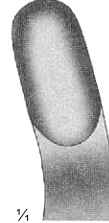

33-952-22
22 cm, 8¾"



33-953-01
23 cm, 9"
2 mm



33-953-02
23 cm, 9"
3 mm



LEKSELL-STILLE
33-950-01
33-950-02

Laterally curved
 Seitwärts gebogen
 Curvas lateral
 Courbure latérale
 Curva lateralmente



FRYKHOLM
33-951-01
33-951-02

Laterally curved
 Seitwärts gebogen
 Curvas lateral
 Courbure latérale
 Curva lateralmente



LUER-STILLE
33-952-22
33-952-22

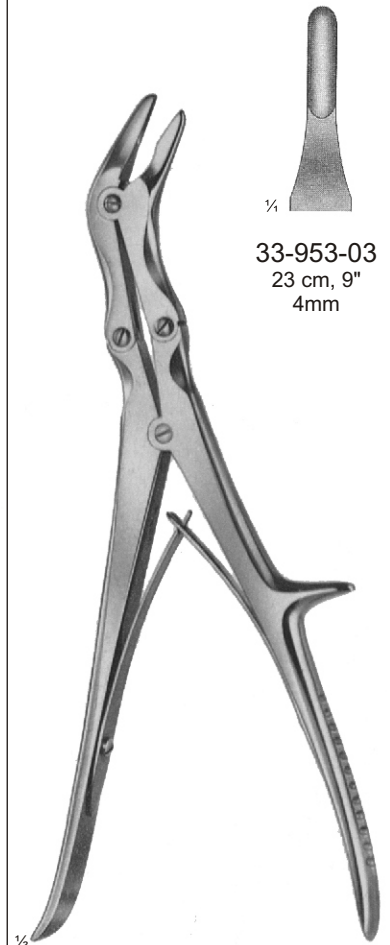

33-953-03
23 cm, 9"
4mm

ECHLIN
33-953-01
33-953-03

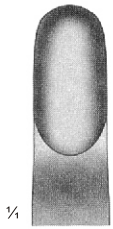
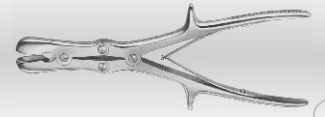

33-955-22
 22 cm, 8¾"

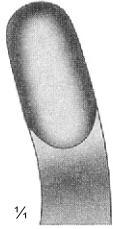

33-955-22
 22 cm, 8¾"



33-956-23
 23 cm, 9"

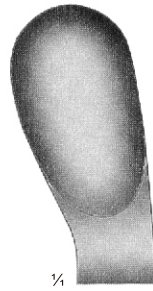

33-957-23
 23 cm, 9"

33-956-27
 27 cm, 10½"

33-957-27
 27 cm, 10½"

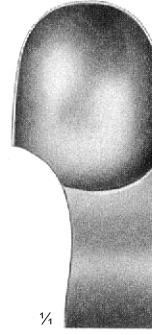

33-958-01
 30 cm, 12"

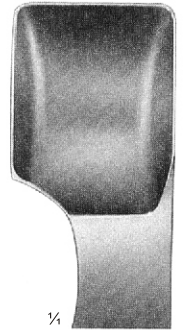

33-958-02
 30 cm, 12"



LUER-STILLE
 33-954-22
 33-955-22



LUER-STILLE
 33-956-23
 33-957-27



SAUERBRUCH
 33-958-01
 33-958-02

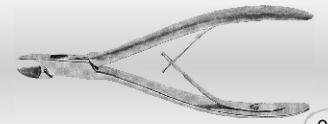

MARKWALDER
 31-126-20
 20 cm, 8"

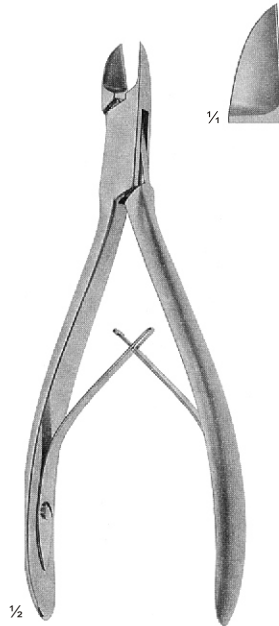

LITTAUER-LISTON
 33-962-15
 15,5 cm, 6"

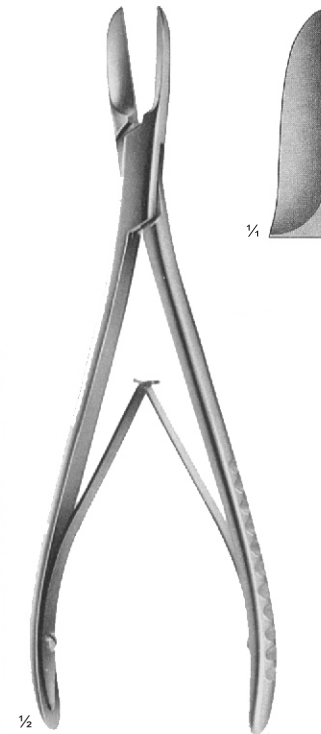

COTTLE
 33-964-19
 19 cm, 7½"



LISTON
 33-966-14
 33-966-22



33-966-14
 14 cm, 5½"



33-966-17
 17 cm, 6¾"



33-966-19
 19 cm, 7½"



33-966-22
 22 cm, 8¾"



LISTON
 33-967-14
 33-967-22



33-967-14
 14 cm, 5½"



33-967-17
 17 cm, 6¾"



33-967-19
 19 cm, 7½"



33-967-22
 22 cm, 8¾"

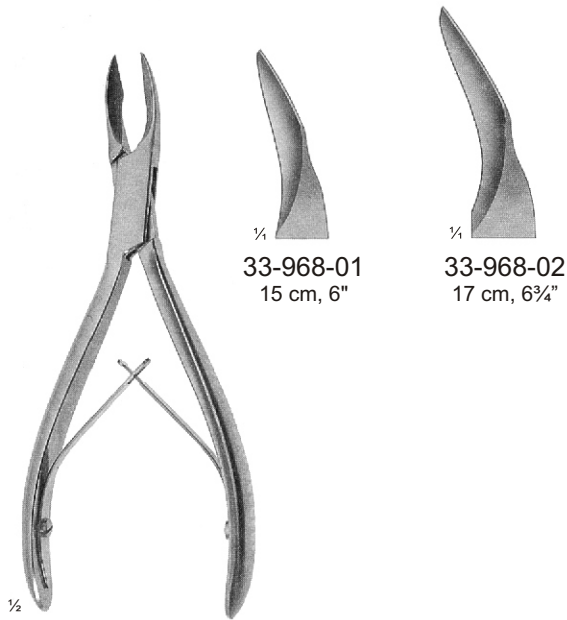
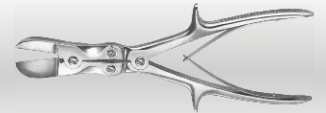

33-968-01
15 cm, 6"

33-968-02
17 cm, 6¾"

CLEVELAND
33-968-01
33-968-02



33-970-01
15 cm, 5¾"

33-970-02
15 cm, 5¾"

BOHLER
33-970-01
33-970-02

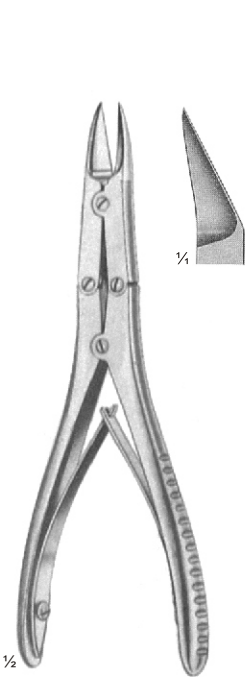

McINDOE
33-971-15
15 cm, 5¾"

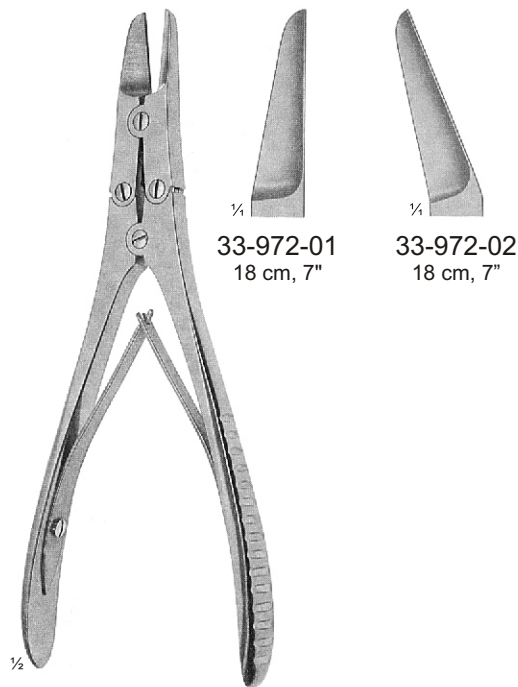

33-972-01
18 cm, 7"

33-972-02
18 cm, 7"

RUSKIN
33-972-01
33-972-02

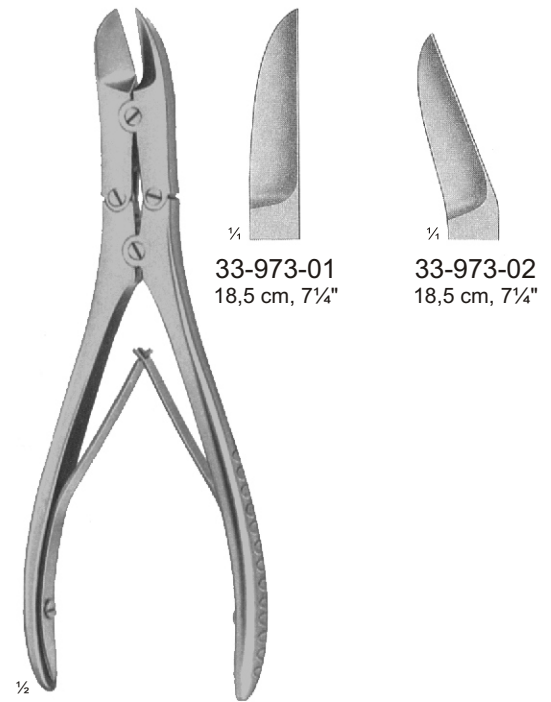

33-973-01
18,5 cm, 7¼"

33-973-02
18,5 cm, 7¼"

RUSKIN-LISTON
33-973-01
33-973-02

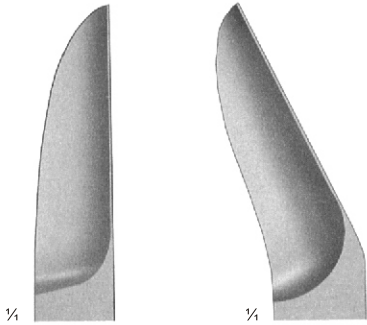
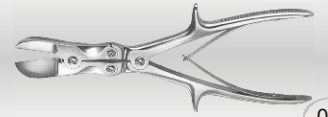

33-975-01
 24 cm, 9½"

33-975-02
 24 cm, 9½"

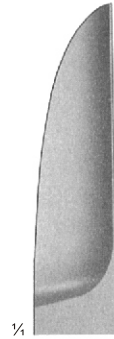

¼

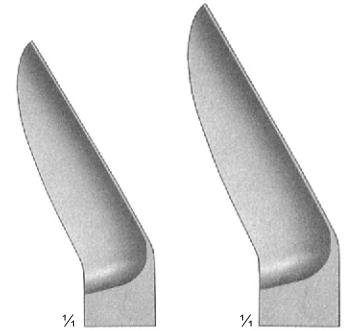

31-132-27
 23 cm, 9¼"

31-133-27
 27 cm, 10¼"



½

LISTON
 33-975-01
 33-975-02

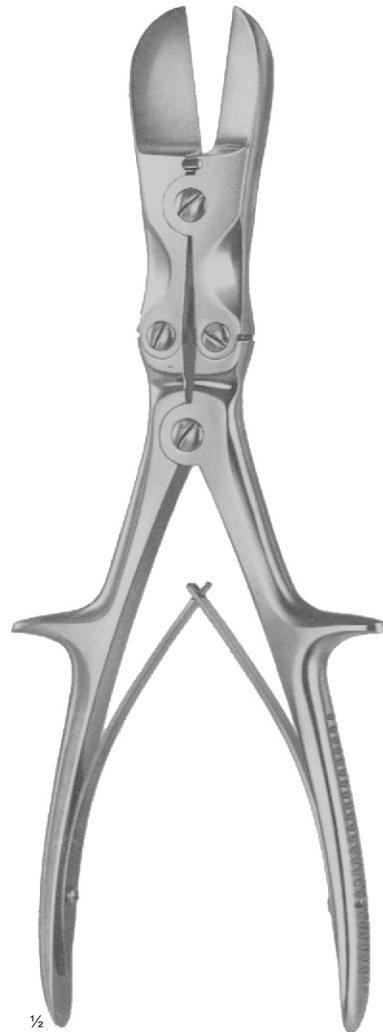

½

STILLE-LISTON
 31-130-27
 27 cm, 10½"



½

STILLE-LISTON
 31-132-27
 31-133-27

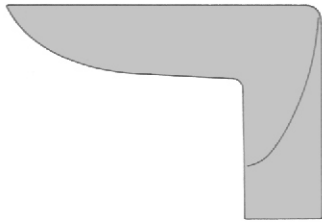
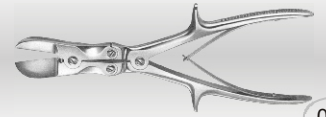

LISTON-STILLE
 33-978-27
 27 cm, 10½"

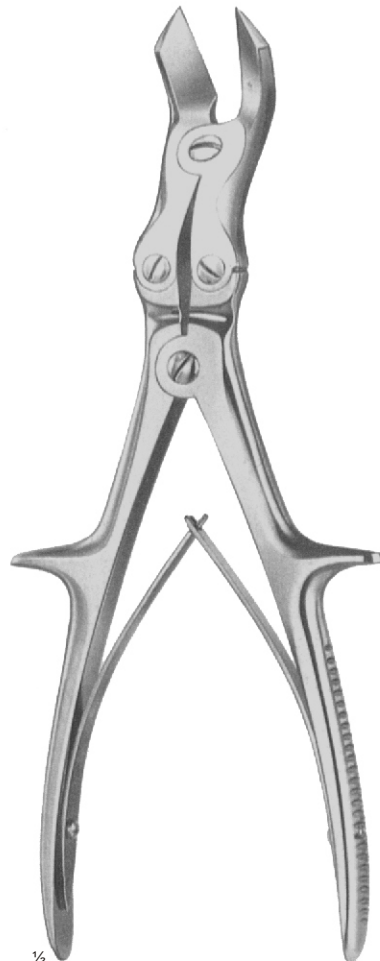
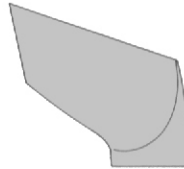

LISTON-KEY-HORSLEY
 31-133-27
 27 cm, 10½"

Bone Cutting forceps, S - shaped, for posterior rib stumps

Knochensplitterzange, doppeit gebogen, für hintere rippenstümpfe

Pinza cortantie para huesos, double curvada, para los muñones de las costillas posteriores

Pince coupantes à os, double courbure pour extrémité des côtes postérieures

Cosoia per ossa, ad „s“ per estremità delle costole posteriori

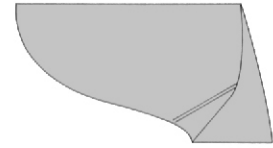

SEMB
 31-137-24
 24 cm, 9½"

Bone cutting forceps, curved sideways, for anterior rib stumps

Knochensplitterzange, seitwärts gebogen, für vordere Rippenstümpfe

Pinza cortante para huesos, curvada lateral, para los muñones de las costillas anteriores

Pince coupantes à os, courbure latérale pour extrémité des côtes antérieure per le estremità delle costole anteriori



Finger Ring Saws
 Fingerringsägen
 Sierras para abrir anillos
 Scies pour bagues
 Seghe per anelli

Finger Nail Instruments
 Fingernagel-Instrumente
 Instrumentos para uñas
 Instruments à ongles
 Strumenti per unghie



033



33-990-01

33-990-16
 16 cm, 6 1/4"

Finger ring saw
 Fingerringaäge
 Sierra para abrir anillos
 Scie pour bagues
 Segha per anelli



33-991-01

33-991-16
 16,5 cm, 6 1/2"

Finger ring saw
 Fingerringaäge
 Sierra para abrir anillos
 Scie pour bagues
 Segha per anelli

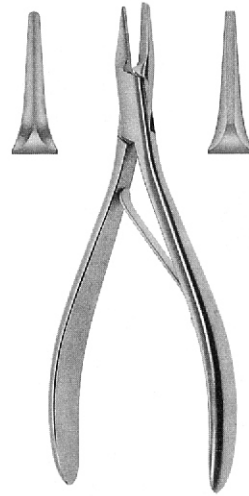

33-992-13
 13 cm, 5"

Nail splitting forceps
 Nagelspaltzange
 Pinza corta-uñas
 Pinca à ongles
 Pinza per unghie

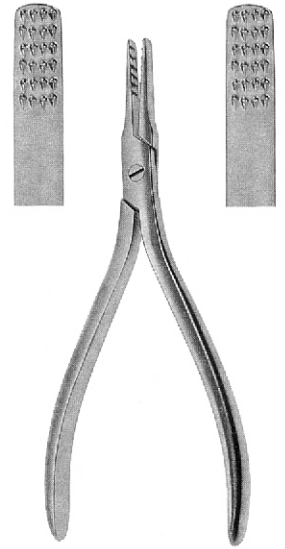

33-994-13
 13,5 cm, 5 1/4"

Nail extracting forceps
 Nagelausreißzange
 Pinza arranca-uñas
 Pince pour extraction des ongles
 Pinza per estrazione delle unghie



33-996-01
 Ø 1,2 mm



33-996-02
 Ø 1,6 mm

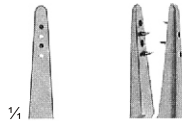

33-996-03
 Ø 2,0 mm



33-996-01
 33-996-03

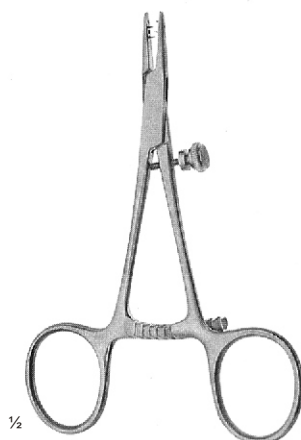

33-997-13
 13 cm, 5"

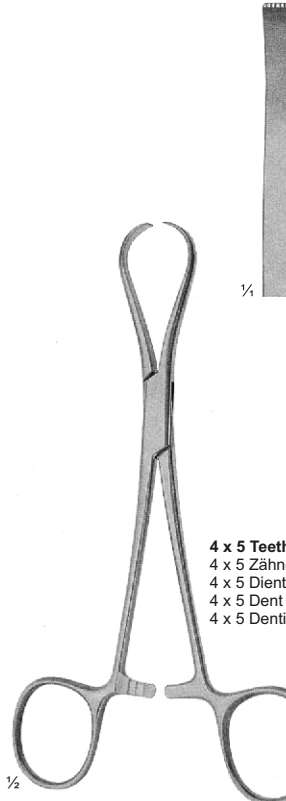

JACKSON
 33-998-15
 15,5 cm, 6"

4 x 5 Teeth
 4 x 5 Zähne
 4 x 5 Dientes
 4 x 5 Dent
 4 x 5 Denti

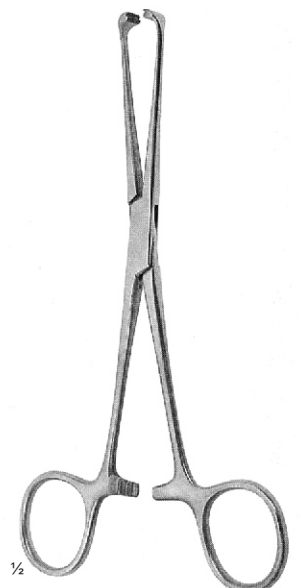
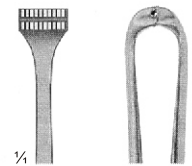

STEINMANN
 33-999-16
 16 cm, 6 1/2"