

035

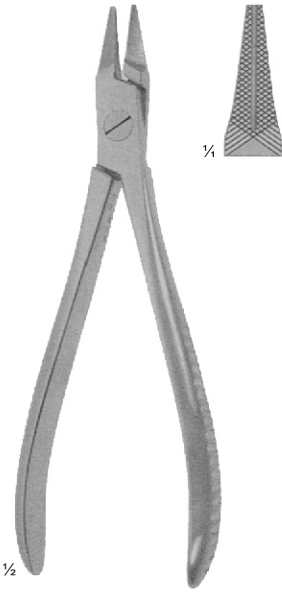

**Bone Surgery**  
**Knochenchirurgie**  
**Cirugía ósea**  
**Chirurgie osseuse**  
**Chirurgia ossea**



35-670-16 59-150-16  
 16 cm, 6¼"

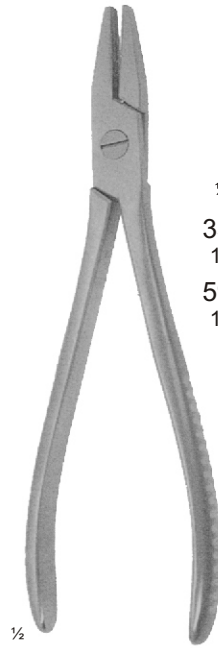

35-672-01  
 35-672-02

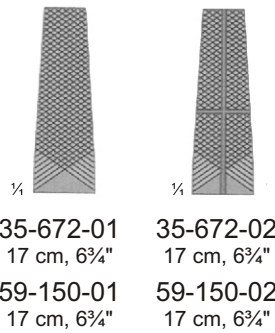

35-672-01 35-672-02  
 17 cm, 6¾" 17 cm, 6¾"  
 59-150-01 59-150-02  
 17 cm, 6¾" 17 cm, 6¾"

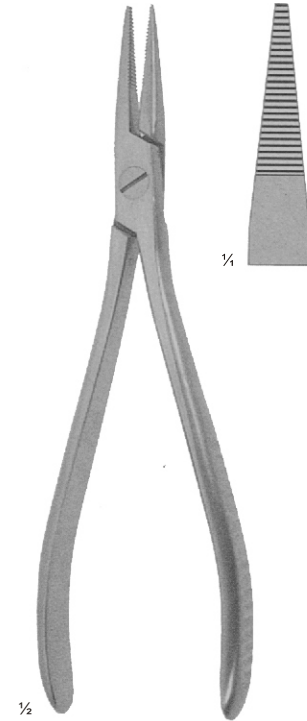

35-674-19  
 19 cm, 7½"

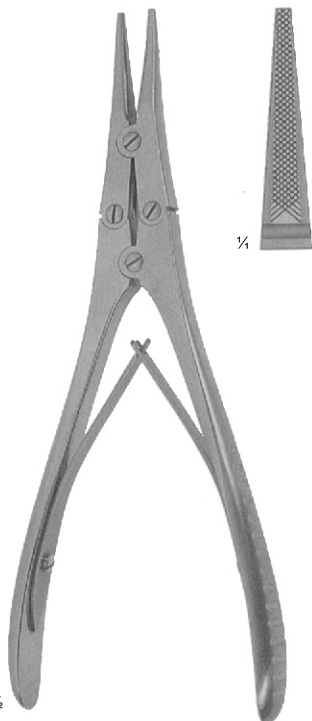

35-676-18  
 18 cm, 7"



35-678-01  
 35-678-03

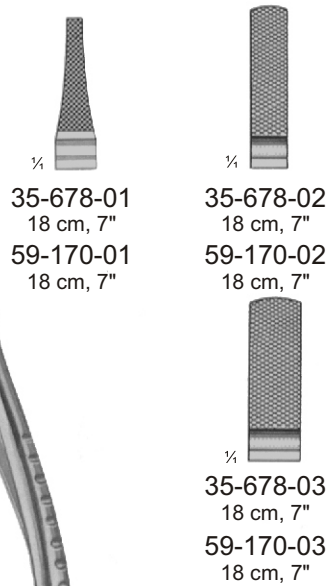

59-170-01  
 59-170-02  
 59-170-03



35-690-01  
 35-690-03

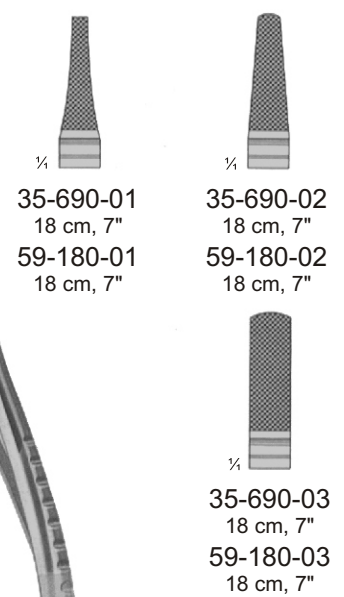

59-180-01  
 59-180-02  
 59-180-03

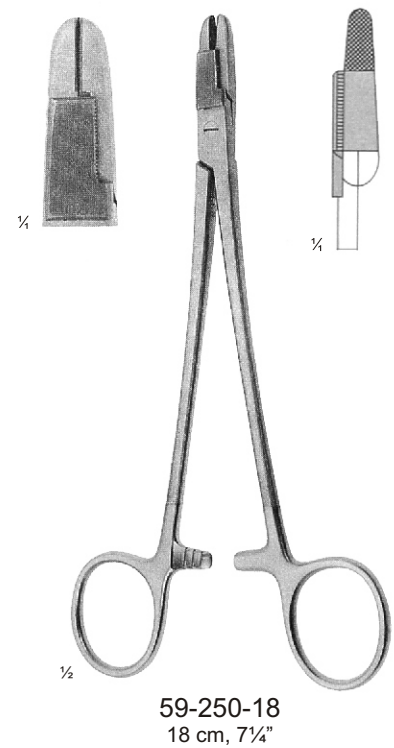
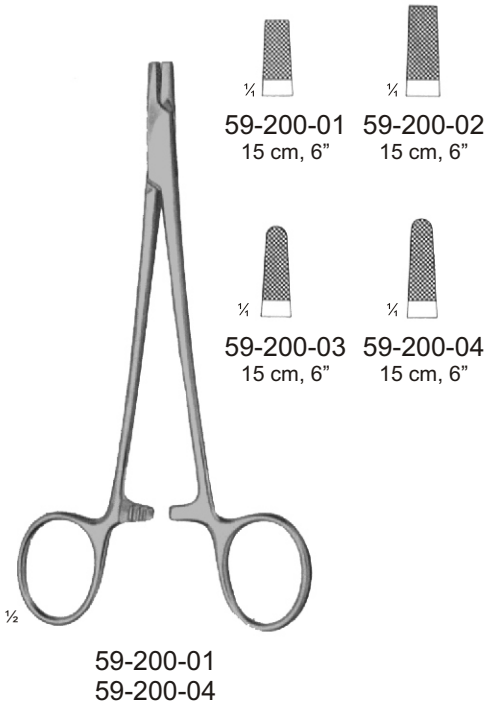

**Wire Twisting Forceps with tungsten carbide inserts**

Drahtspannzangen mit Hartmetalleinlagen  
 Pinzas cierra-hilos con bocas de carburo tungsteno  
 Pincers serre-fils avec mors en tungstène  
 Pinze gira cavo con morsi in carburo di tungsteno



35-700-17  
17 cm, 6½"

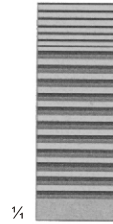
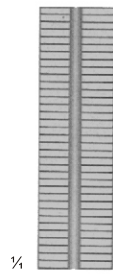
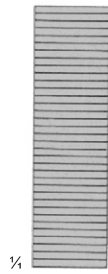

35-702-18  
18 cm, 7"



35-710-16  
16 cm, 6¼"



35-712-15  
15 cm, 6"

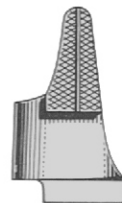

35-716-14  
14,5 cm, 5¾"

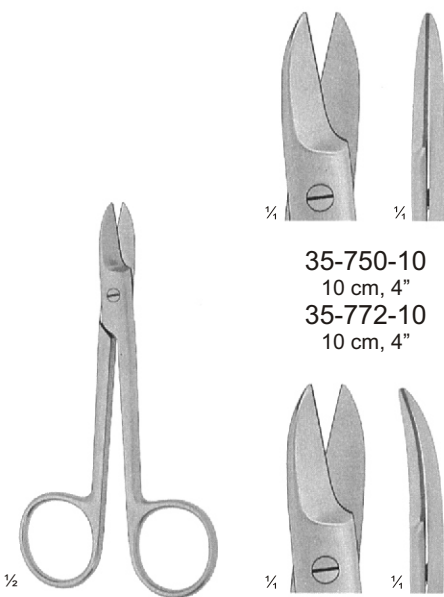

**BEEBEE**  
 35-750-10  
 35-753-10

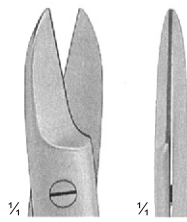

35-750-10  
 10 cm, 4"  
 35-772-10  
 10 cm, 4"

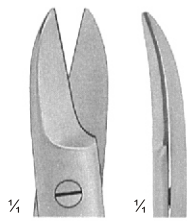

35-751-12  
 12 cm, 4¾"  
 35-753-12  
 12 cm, 4¾"

**For soft wire up to diam.**  
 für weichen Draht bis ø  
 para blandos hasta un diam. de  
 pour couper les fils moux jusqu'à ø  
 per cavi leggeri con ø superiore a

0,4 mm

35-752-10  
 35-753-12

**For hard wire up to diam.**  
 für harten Draht bis ø  
 para duros hasta un diam. de  
 pour couper les fils durs jusqu'à ø  
 per cavi duri con ø superiore a

0,3 mm

**1 blade serrated**  
 1 blatt gezahnt  
 1 hoja dentada  
 1 lame dentelée  
 1 lama dentata

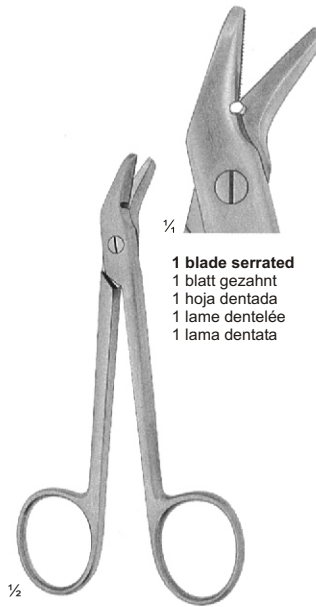

**UNIVERSAL**  
 35-760-12  
 12 cm, 4¾"

**1 blade serrated**  
 1 blatt gezahnt  
 1 hoja dentada  
 1 lame dentelée  
 1 lama dentata

**for soft wire up to diam.**  
 für weichen Draht bis ø  
 para blandos hasta un diam. de  
 pour couper les fils moux jusqu'à ø  
 per cavi leggeri con ø superiore a

1,2 mm

**for hard wire up to diam.**  
 für harten Draht bis ø  
 para duros hasta un diam. de  
 pour couper les fils durs jusqu'à ø  
 per cavi duri con ø superiore a

0,8 mm

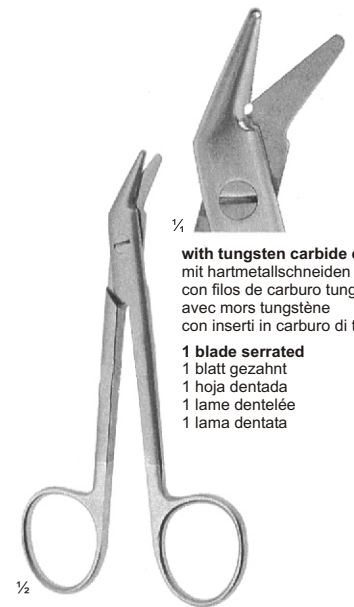

**UNIVERSAL**  
 51-296-12  
 12 cm, 5"

**with tungsten carbide edges**  
 mit hartmetallschneiden  
 con fillos de carburo tungsteno  
 avec mors tungstène  
 con inserti in carburo di tungsteno

**1 blade serrated**  
 1 blatt gezahnt  
 1 hoja dentada  
 1 lame dentelée  
 1 lama dentata

**for soft wire up to diam.**  
 für weichen Draht bis ø  
 para blandos hasta un diam. de  
 pour couper les fils moux jusqu'à ø  
 per cavi leggeri con ø superiore a

1,2 mm

**for hard wire up to diam.**  
 für harten Draht bis ø  
 para duros hasta un diam. de  
 pour couper les fils durs jusqu'à ø  
 per cavi duri con ø superiore a

0,8 mm

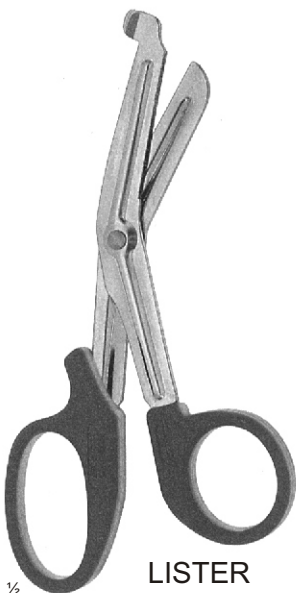

**LISTER**  
 37-114-15  
 37-114-18



37-114-15  
 15 cm, 6"

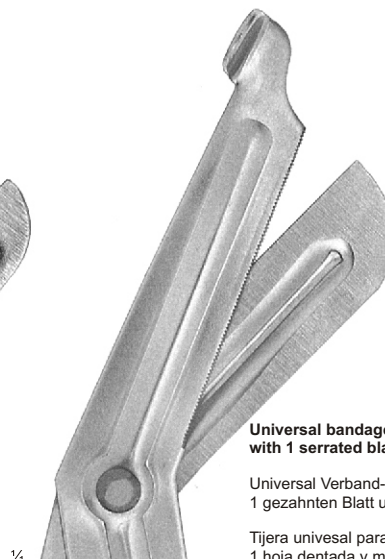

37-114-18  
 18 cm, 7"

**Universal bandage and cloth scissors, made of acid-proof stainless steel, with 1 serrated blade and plastic handles, autoclavable up to 134°C.**

Universal Verband- und Klederstoffschere aus rostfreiem, säurebeständigem Stahl, mit 1 gezahnten Blatt und Kunststoffgriffen, bis 134°C im Autoklaven sterilisierbar.

Tijera univesal para vendajes y. tela, acero inoxidable y reai-stente a los ácidos, con 1 hoja dentada y mangos de plástico, esterilizable en autoclave hasta 134°C.

Ciseaux universels pour étoffes en acier inox, avec 1 lame crantée et anneaux en plastique, autoclavables à 134°C.

Cesoie per bendaggi e vestiti, in acciaio inox resistente agli acidi con 1 lama dentata, manico in plastica, sterilizzabile in autoclave fino 134°C.

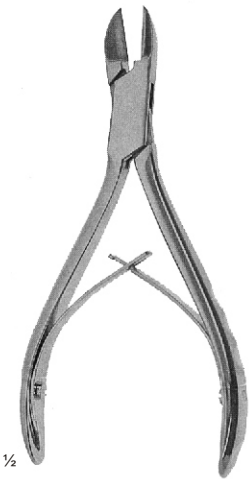

35-780-11  
 11 cm, 4½"  
 35-780-13  
 13 cm, 5"  
 35-780-15  
 15 cm, 6"

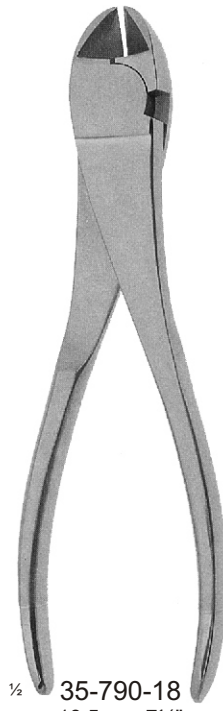

35-790-18  
 18,5 cm, 7¼"

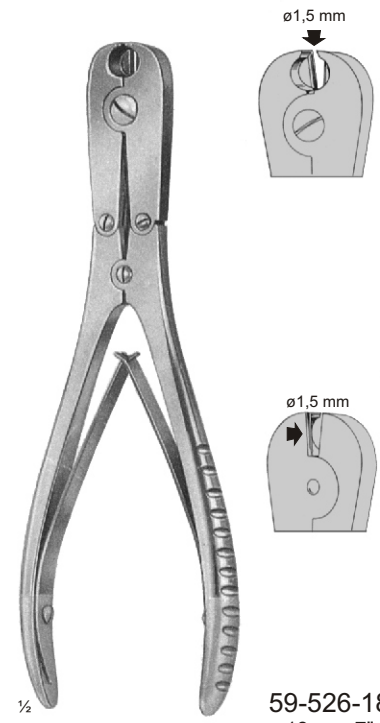

ø1,5 mm

ø1,5 mm

59-526-18  
 18 cm, 7"



59-530-16  
 16 cm, 5½"



59-532-22  
 22 cm, 8¾"

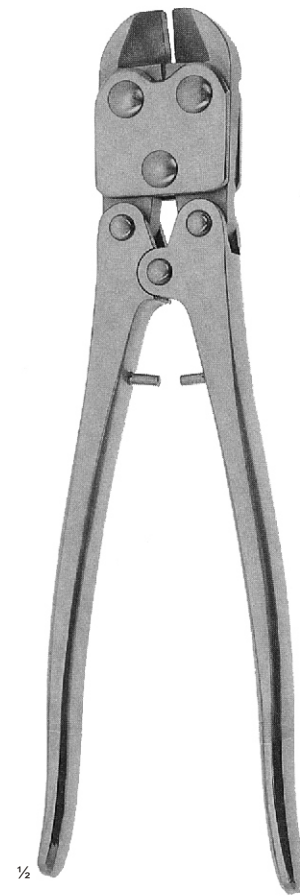

35-800-23  
 23,5 cm, 9¼"



35-810-16  
16 cm, 6¼"



35-812-16  
16 cm, 6¼"

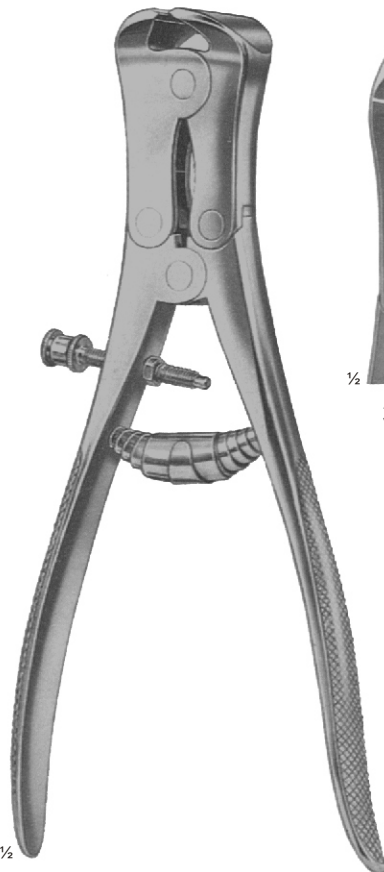

35-814-23  
23 cm, 9"



35-816-25  
25 cm, 9¾"



35-818-48 48 cm, 18¾"  
35-818-54 54 cm, 21¼"

59-550-48 48 cm, 18¾"  
59-550-54 54 cm, 21¼"

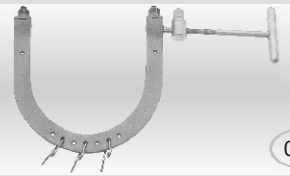

**DEMEL**  
 35-820-27  
 35-820-30

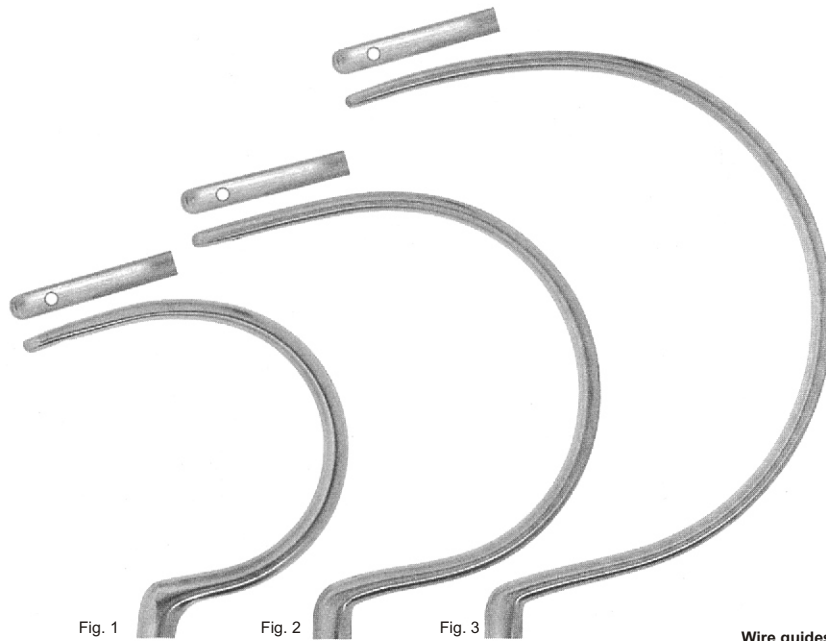

Fig. 1

35-820-27  
 27,5 cm, 10¾"

Fig. 2

35-820-28  
 28,5 cm, 11¼"

Fig. 3

35-820-30  
 30,5 cm, 12"

**Wire guides**  
 Drahtumführungs-nadeln  
 Agujas pasa hilos  
 Aiguilles passe-fils  
 Guida cavo



½

35-822-24  
 35-822-27



Fig. 1

35-822-24  
 24 cm, 9½"

**Hollow,sharp**  
 Hohl,spitz  
 Hueco,agudo  
 Creux,pointu  
 Cavo,acuto

Fig. 2

35-822-27  
 27 cm, 10¾"

**Hollow,sharp**  
 Hohl,spitz  
 Hueco,agudo  
 Creux,pointu  
 Cavo,acuto



½

35-823-22  
 22,5 cm, 9"

**Hollow,sharp**  
 Hohl,spitz  
 Hueco,agudo  
 Creux,pointu  
 Cavo,acuto



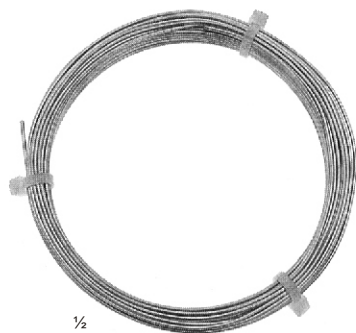
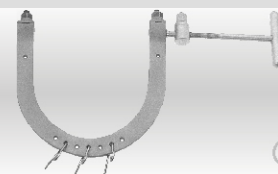

1/2

mm ø	malleabile
0,2	35-825-01
0,3	35-825-02
0,4	35-825-03
0,5	35-825-04
<hr/>	
0,6	35-825-05
0,7	35-825-06
0,8	35-825-07
0,9	35-825-08
<hr/>	
1,0	35-825-09
1,2	35-825-10
1,5	35-825-11

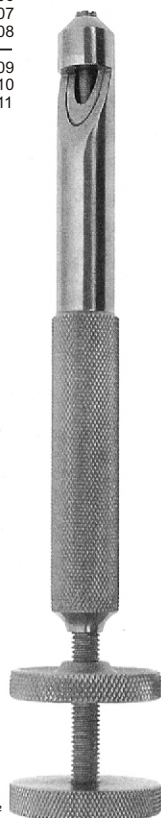

1/2

**LOUTE**  
**35-830-21**  
 21 cm, 8 1/4"

**Wire tightener, with movable tip, for wires up to 1.0 mm diam,**

Drahtspanner mit an der spitze eingebauter beweglicher Drahtspannbüchese für Cerclage-dähte bis ø 1 mm

Tensor cierra-hilo con manguito movable en la punta, para hilos de cerclaje hasta ø 1 mm

Serre-fil avec manche mobile intégré a la pointe pour fil fe cerclage jusqu a ø 1 mm

Trenditore serra filo con manico mobile sulla punta, per filli di cerchiaggio da 1 mm. di ø

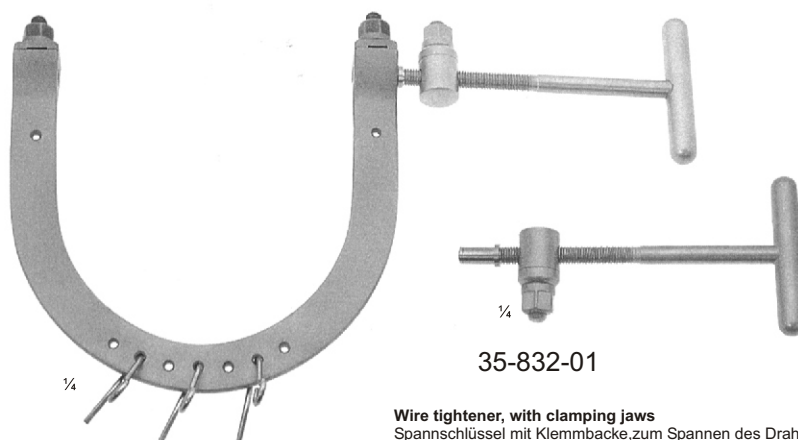

1/4

**35-832-01**

**Wire tightener, with clamping jaws**  
 Spanschlüssel mit Klemmbacke, zum Spannen des Drahtes  
 Tensor de alambres  
 Tendeur de broches avec mors clampants  
 Strumento tenditore con morso a presa

Depth	Width
Tiefe	Weite
Profundidad	Anchura interior
Profondité	Largeur ouverte
Profondità	Larghezza interna

Application
Anwendung
Aplicación
Application
Applicazione

<b>35-830-01</b>	95 mm, 3 3/4"	70 mm, 2 3/4"	<b>Arm and elbow</b>	Arm und Ellenbogen	Brazy y code	Bras et poignet	Braccio e gomito
<b>35-830-02</b>	95 mm, 3 3/4"	110 mm, 4 3/4"	<b>calcaneus</b>	Fersenbein	clacáneo	calcaneum	calgagno
<b>35-830-03</b>	105 mm, 4 1/4"	100 mm, 4"	<b>knee</b>	Knie	rodilla	genou	ginocchio
<b>35-830-04</b>	120 mm, 4 3/4"	120 mm, 4 3/4"	<b>knee</b>	Knie	rodilla	genou	ginocchio
<b>35-830-05</b>	135 mm, 5 1/4"	130 mm, 5 1/4"	<b>knee</b>	Knie	rodilla	genou	ginocchio
<b>35-830-06</b>	155 mm, 6"	155 mm, 6"	<b>femur</b>	Oberschenkel	fémur	fémur	femore
<b>35-830-07</b>	200 mm, 8"	155 mm, 6"	<b>hip</b>	Hüfte	coxa	hanche	anca

**Wire traction bow with 3 traction hooks, to be used with KIRSCHNER wires up to 2.5 mm diam.**  
 Extensionsbügel mit 3 Zughaken, zur Verwendung mit KIRSCHNER Drähten bis ø 2,5 mm diam.  
 Estribos para extensión con 3 ganchos de tracción, para agujas de KIRSCHNER hasta ø 2,5 mm  
 Etriers à extension avec 3 crochets de traction, pour broches KIRSCHNER ø 2,5 mm  
 Archi per trazione con 3 ganci di trazione, da impiegarsi con filli KIRSCHNER superiori a 2,5 mm di ø

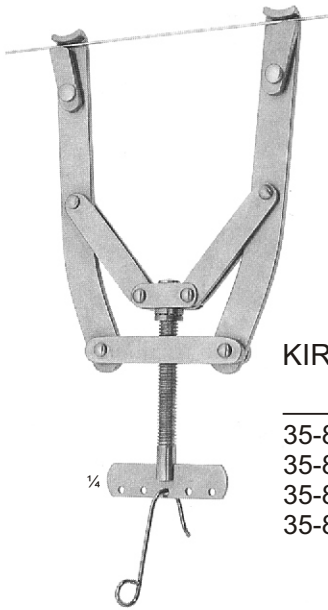
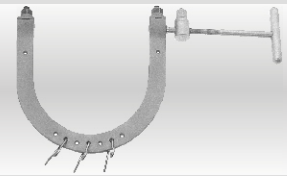

**KIRSCHNER**

	cm	in
35-836-01	20	8
35-836-02	27	10½
35-836-03	33	13
35-836-04	38	15

Wire traction bow with 3 traction hooks, to be used with KIRSCHNER wires up to ø 1,6 mm ø 2,0 mm ø 2,5 mm adjustable, hold wire securely

Extensionsbügel mit 3 Zughaken, zur Verwendung mit KIRSCHNER drähten bis ø 1,6 mm ø 2,0 mm, ø 2,5 mm verstellbar, selbsthemmend

Estribo para extensión con 3 ganchos de tracción, para agujas de KIRSCHNER hasta ø 1,6 mm ø 2 mm, ø 2,5 mm, ajustable, sujeto seguro de la aguja

Etrier à extension avec 3 crochets de traction, pour broches KIRSCHNER ø 1,6 mm ø 2 mm, ø 2,5 mm, réglable, avec blocage des broches

Archi per trazione con 3 ganci di trazione, da impiegarsi con fili KIRSCHNER superiori a ø 1,6 mm ø 2 mm, ø 2,5 mm, regolabile, filli in sicurezza

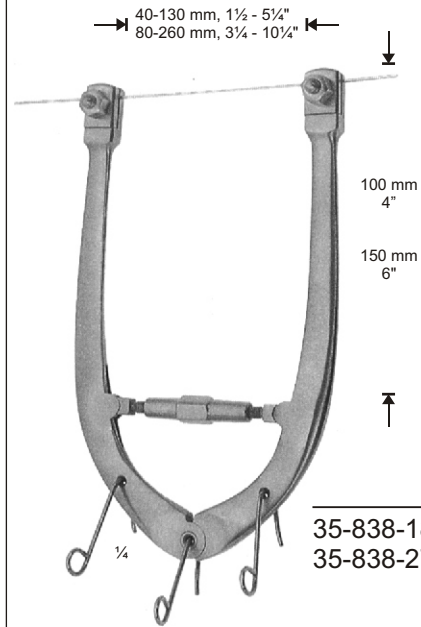

	cm	in
35-838-18	18x10	7x4
35-838-27	27x16	10½x6¼

Wire traction bow with 3 traction hooks, to be used with KIRSCHNER wires up to ø 2 mm diam, ø 2,5 mm diam, adjustable

Extensionsbügel mit 3 Zughaken, zur Verwendung mit KIRSCHNER Drähten bis ø 2 mm, ø 2,5 mm verstellbar

Estribo para extensión con 3 gancho de tracción, para agujas de KIRSCHNER hasta ø 2 mm, 2,5 mm ajustable

Etrier à extension avec 1 crochet de traction, pour broches KIRSCHNER ø 2 mm, 2,5 mm, réglable

Archi per trazione con 1 ganci di trazione, da impiegarsi con filli KIRSCHNER superiori a 2 mm di ø 2 mm di ø regolabile

**Fixation discs**  
 Begrenzungsplatten  
 Discos de fijación  
 Disques de fixation  
 Dischi di fissaggio



35-842-01

Pair, Paar, Par, Paire, Paio

**Fixation discs for drill wires**  
 Fixierscheiben für Bohrdrähte  
 Discos fijadores para taladros filiformes  
 Disques de fixation pour broches  
 Dischi fissatori per i perforatori filiformi

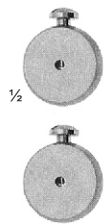

35-842-02

Pair, Paar, Par, Paire, Paio



35-842-03



35-842-04

**Screw nut wrench**  
 Mutternschlüssel  
 Llave de tuercas  
 Clé de serrage  
 Chiave per madreviti



35-842-05

19 cm, 7½"

**Screw driver**  
 Schraubendreher  
 Atornillador  
 Tourne-vis  
 Cacciavite

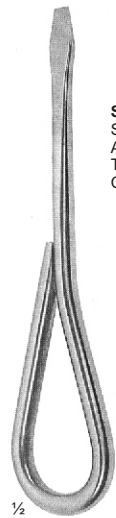

35-842-06

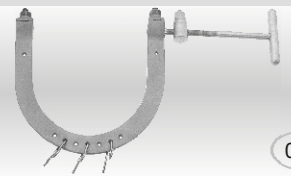

**KIRSCHNER**

	cm	in
35-840-01	20	8
35-840-02	27	10½
35-840-03	33	13
35-840-04	38	15

**Wire traction bow with 3 traction hooks, to be used with KIRSCHNER wires up to ø 1,6 mm ø 2,0 mm ø 2,5 mm adjustable, hold wire securely**

Extensionsbügel mit 3 Zughaken, zur Verwendung mit KIRSCHNER drähten bis ø 1,6 mm ø 2,0 mm, ø 2,5 mm verstellbar, selbsthemmend

Estribo para extensión con 3 ganchos de tracción, para agujas de KIRSCHNER hasta ø 1,6 mm ø 2 mm, ø 2,5 mm, ajustable, sujeto seguro de la aguja

Etrier à extension avec 3 crochets de traction, pour broches KIRSCHNER ø 1,6 mm ø 2 mm, ø 2,5 mm, réglable, avec blocage des broches

Archi per trazione con 3 ganci di trazione, da impiegarsi con fill KIRSCHNER superiori a ø 1,6 mm ø 2 mm, ø 2,5 mm, regolabile, filli in sicurezza

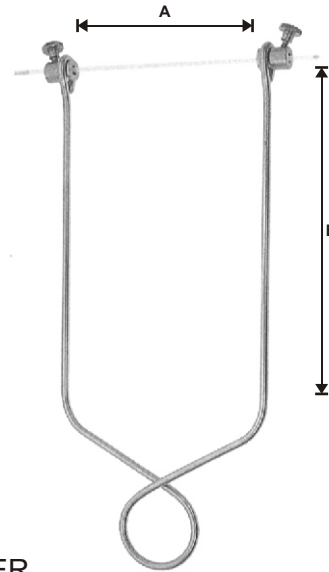

**BOHLER**

**35-842-01**  
 160 x 190 mm  
 6¼" x 7½"

**Wire tractoin bow for arm, to be used with STEINMANN pins, ø 4 mm diam.**

Extensionsbügel für Arm, zur Verwendung von STEINMANN Nägel ø 4 mm

Estribo para extensión de brazo, para clavos de STEINMANN ø mm diam.

Etrier de traction pour bras, utilisé ø 4 mm

Etrier de traction pour bras, utilisé avec clou de STEINMANN ø 4 mm

Cavo per arco di trazione per braccio, da impiegarsi con chiodi STEINMANN, ø 4 mm

**35-842-02**  
 210 x 110 mm  
 8¼" x 4¾"

**Wire tractoin bow for thigh and knee, to be used with STEINMANN pins, 4 mm diam.**

Extensionsbügel für Oberschenkel und knie, zur Verwendung von STEINMANN Nägel ø 4 mm

Estribo para extensión del muslo y de la rodilla, para clavos de STEINMANN ø mm diam.

Etrier de traction pour vras, utilisé ø 4 mm

Etrier de action pour femur et genou, utilisé avec clou de STEINMANN ø 4 mm

Cavo per arco di trazione per cossia e ginocchio, da impiegarsi con chiodi STEINMANN, ø 4 mm

**35-842-03**  
 210 x 150 mm  
 8¼" x 6"

**Wire tractoin bow for thigh and knee, to be used with STEINMANN pins, 4 mm diam.**

Extensionsbügel für Oberschenkel und knie, zur Verwendung von STEINMANN Nägel ø 4 mm

Estribo para extensión del muslo y de la rodilla, para clavos de STEINMANN ø mm diam.

Etrier de traction pour vras, utilisé ø 4 mm

Etrier de action pour femur et genou, utilisé avec clou de STEINMANN ø 4 mm

Cavo per arco di trazione per cossia e ginocchio, da impiegarsi con chiodi STEINMANN, ø 4 mm

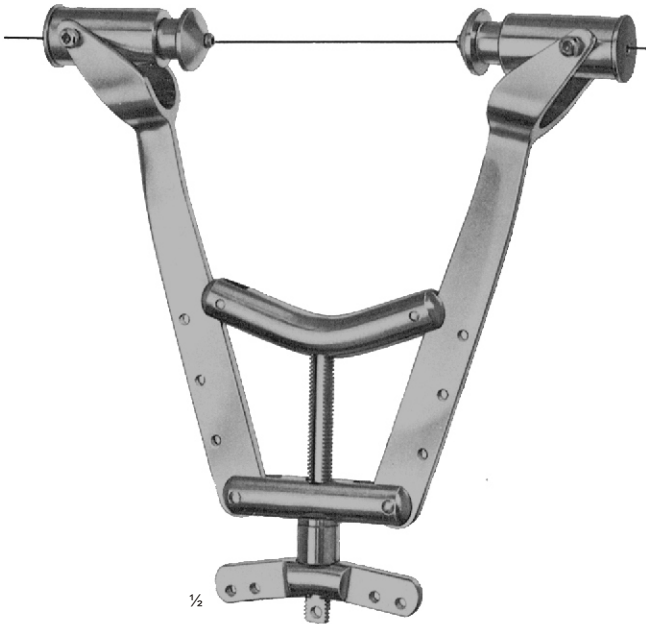
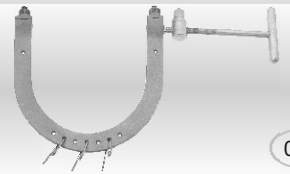

**SCHRAMBERG**  
 35-844-01  
 35-844-02  
 35-844-03



**PALMER**  
 35-846-15  
 15 cm, 6"



**PALMER**  
 35-846-17  
 17,5 cm, 7"



	Ø 5mm	
35-850-08	Ø 8cm	3¼"
35-850-12	Ø 12cm	4¾"
35-850-15	Ø 15cm	6"
35-850-17	Ø 17cm	7"
35-850-20	Ø 20cm	8"
35-850-25	Ø 25cm	10"



**SCHANZ**



	Ø 5mm	
35-852-15	15cm	6"
35-852-20	20cm	8"
35-852-25	25cm	10"
35-852-30	30cm	12"
35-852-35	35cm	13¾"
35-852-40	40cm	15¾"
35-852-45	45cm	17¾"
35-852-50	50cm	20"
35-852-55	55cm	21½"
35-852-60	60cm	23½"
35-852-65	65cm	25½"
35-852-70	70cm	27½"

**PALMER**  
 1,5 mm ø



35-854-16

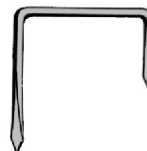

35-854-19

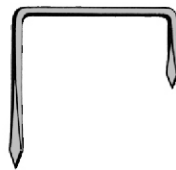

35-854-22

**WILBERG**  
 35-854-16  
 35-854-22

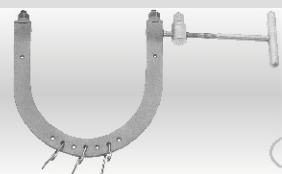

**STEINMANN**

35-860-08	ø4 x 80 mm
35-860-10	ø4 x 100 mm
35-860-12	ø4 x 120 mm
35-860-14	ø4 x 140 mm
35-860-15	ø4 x 150 mm
35-860-16	ø4 x 160 mm
35-860-18	ø4 x 180 mm
35-860-20	ø4 x 200 mm
35-860-21	ø4 x 210 mm
35-860-25	ø4 x 250 mm



15 cm, 6"		31 cm, 12¼"
35-664-08	ø 0,8 mm	35-668-08
35-664-10	ø 1,0 mm	35-668-10
35-664-12	ø 1,2 mm	35-668-12
35-664-14	ø 1,4 mm	35-668-14
35-664-15	ø 1,5 mm	35-668-15
35-664-16	ø 1,6 mm	35-668-16
35-664-18	ø 1,8 mm	35-668-18
35-664-20	ø 2,0 mm	35-668-20
35-664-22	ø 2,2 mm	35-668-22
35-664-25	ø 2,5 mm	35-668-25
35-664-30	ø 3,0 mm	35-668-30



15 cm, 6"		31 cm, 12¼"
35-870-08	ø 0,8 mm	35-872-08
35-870-10	ø 1,0 mm	35-872-10
35-870-12	ø 1,2 mm	35-872-12
35-870-14	ø 1,4 mm	35-872-14
35-870-15	ø 1,5 mm	35-872-15
35-870-16	ø 1,6 mm	35-872-16
35-870-18	ø 1,8 mm	35-872-18
35-870-20	ø 2,0 mm	35-872-20
35-870-22	ø 2,2 mm	35-872-22
35-870-25	ø 2,5 mm	35-872-25
35-870-30	ø 3,0 mm	35-872-30



	10 cm, 4"	15 cm, 6"	31 cm, 12¼"
ø 0,8 mm	35-876-08	35-878-08	35-880-08
ø 1,0 mm	35-876-10	35-878-10	35-880-10
ø 1,2 mm	35-876-12	35-878-12	35-880-12
ø 1,4 mm	35-876-14	35-878-14	35-880-14
ø 1,5 mm	35-876-15	35-878-15	35-880-15
ø 1,6 mm	35-876-16	35-878-16	35-880-16
ø 1,8 mm	35-876-18	35-878-18	35-880-18
ø 2,0 mm	35-876-20	35-878-20	35-880-20
ø 2,2 mm	35-876-22	35-878-22	35-880-22
ø 2,5 mm	35-876-25	35-878-25	35-880-25
ø 3,0 mm	35-876-30	35-878-30	35-880-30



**Intramedullary Pins, round, with hook**  
 Marknägel rund, mit haken  
 Clavos intramedulares, redondos, con ganchos  
 Clous médullaires, ronds, avec crochet  
 Chiodi intamidollari, rotondi, con gancio

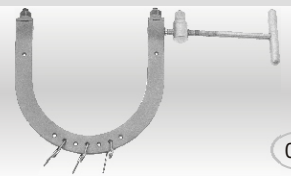

035

Length Länge Largo Longueur Lunghezza mm	2,5 mm ø	3,2 mm ø	4,8 mm ø	6,4 mm ø
25	35-890-01			
30	35-890-02			
40	35-890-03			
45	35-890-04			
50	35-890-05			
60	35-890-06			
65	35-890-07			
70	35-890-08			
75	35-890-09			
85	35-890-10			
90	35-890-11			
95	35-890-12			
100	35-890-13	35-892-13		
115	35-890-14	35-892-14		
125	35-890-15	35-892-15		
140	35-890-16	35-892-16		
150	35-890-17	35-892-17		
165	35-890-18	35-892-18		
180	35-890-19	35-892-19		
190	35-890-20	35-892-20		
205	35-890-21	35-892-21	35-894-21	
215	35-890-22	35-892-22		
220			35-894-23	
235		35-892-24		
240	35-890-25	35-892-25	35-894-25	
250				
255	35-890-27	35-892-27	35-894-27	
280			35-894-28	35-896-28
295			35-894-29	35-896-29
300				
315			35-894-31	35-896-31
335			35-894-32	35-896-32
355			35-894-33	35-896-33
375				35-896-34
395				35-896-35
410				35-896-36
430				35-896-37
Set with rack Satz mit Halter Juego can soporte Jeu aec porte-clous Set con fermo	35-890-00 25-100 mm (13)	35-892-00 100-255 mm (13)	35-894-00 205-355 mm (9)	35-896-00 280-430 mm (9)
Set with rack Satz mit Halter Juego can soporte Jeu aec porte-clous Set con fermo	35-891-00 100-255 mm (13)			
Rack, only Halter, allein Soporte, suelto Porte-clous, seul solo fermo	35-891-01 2,4 mm	35-893-01 3,2 mm	35-895-01 4,8 mm	35-897-01 6,4 mm

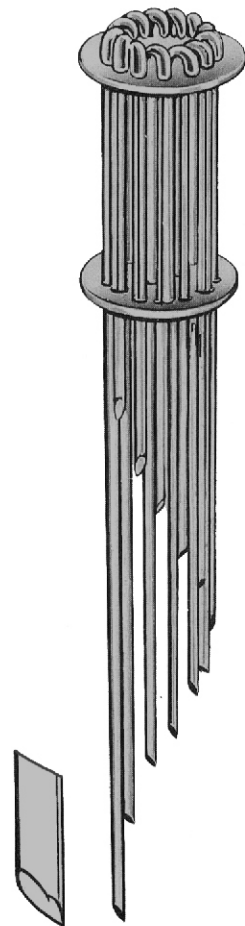



**Küntscher Intramedullary Nails**  
 Küntscher Nägel für Oberschenkel  
 Küntscher Clavos Intramedulares  
 Küntscher clous pour fémur  
 Chiodi di Küntscher per femore

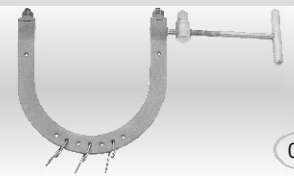

035

With 1 eye, ,ot 1 Öse, con 1 oja, avec 1 oeillet, con 1 foro



Length Länge Largo Longueur Lunghezza cm in		Fig. 1	Fig. 2	Fig. 3	Fig. 4	Fig. 5	Fig. 6	Fig. 7	Fig. 8	Fig. 9	Fig. 10	Fig. 11
		ø 6 mm	ø 7 mm	ø 8 mm	ø 9 mm	ø 10 mm	ø 11 mm	ø 12 mm	ø 13 mm	ø 14 mm	ø 15 mm	ø 16 mm
18 cm	7	35-900-18	35-901-18									
20 cm	8	35-900-20	35-901-20									
22 cm	8¾	35-900-22	35-901-22									
24 cm	9½	35-900-24	35-901-24	35-902-24								
26 cm	10¼	35-900-26	35-901-26	35-902-26								
28 cm	11	35-900-28	35-901-28	35-902-28								
30 cm	12	35-900-30	35-901-30	35-902-30	35-903-30		35-905-30					
32 cm	12½	35-900-32	35-901-32	35-902-32	35-903-32	35-904-32	35-905-32					
34 cm	13½	35-900-34	35-901-34	35-902-34	35-903-34	35-904-34	35-905-34	35-906-34	35-907-34	35-908-34		
36 cm	14		35-901-36	35-902-36	35-903-36	35-904-36	35-905-36	35-906-36	35-907-36	35-908-36		
38 cm	15		35-901-38	35-902-38	35-903-38	35-904-38	35-905-38	35-906-38	35-907-38	35-908-38	35-909-38	35-910-38
40 cm	15¾		35-901-40	35-902-40	35-903-40	35-904-40	35-905-40	35-906-40	35-907-40	35-908-40	35-909-40	35-910-40
42 cm	16½			35-902-42	35-903-42	35-904-42	35-905-42	35-906-42	35-907-42	35-908-42	35-909-42	35-910-42
44 cm	17¼			35-902-44	35-903-44	35-904-44	35-905-44	35-906-44	35-907-44	35-908-44	35-909-44	35-910-44
46 cm	18			35-902-46	35-903-46	35-904-46	35-905-46	35-906-46	35-907-46	35-908-46	35-909-46	35-910-46
48 cm	19			35-902-48	35-903-48	35-904-48	35-905-48	35-906-48	35-907-48	35-908-48	35-909-48	35-910-48
50 cm	19¾			35-902-50	35-903-50	35-904-50	35-905-50	35-906-50	35-907-50	35-908-50	35-909-50	35-910-50
52 cm	20½				35-903-52	35-904-52	35-905-52	35-906-52	35-907-52	35-908-52	35-909-52	35-910-52

With 2 eye, ,ot 2 Öse, con 2 oja, avec 2 oeillet, con 2 foro



Length Länge Largo Longueur Lunghezza cm in		Fig. 1	Fig. 2	Fig. 3	Fig. 4	Fig. 5	Fig. 6	Fig. 7	Fig. 8	Fig. 9	Fig. 10	Fig. 11
		ø 6 mm	ø 7 mm	ø 8 mm	ø 9 mm	ø 10 mm	ø 11 mm	ø 12 mm	ø 13 mm	ø 14 mm	ø 15 mm	ø 16 mm
18 cm	7	35-920-18	35-921-18									
20 cm	8	35-920-20	35-921-20									
22 cm	8¾	35-920-22	35-921-22									
24 cm	9½	35-920-24	35-921-24	35-922-24								
26 cm	10¼	35-920-26	35-921-26	35-922-26								
28 cm	11	35-920-28	35-921-28	35-922-28								
30 cm	12	35-920-30	35-921-30	35-922-30	35-923-30		35-925-30					
32 cm	12½	35-920-32	35-921-32	35-922-32	35-923-32	35-924-32	35-925-32					
34 cm	13½	35-920-34	35-921-34	35-922-34	35-923-34	35-924-34	35-925-34	35-926-34	35-927-34	35-928-34		
36 cm	14		35-921-36	35-922-36	35-923-36	35-924-36	35-925-36	35-926-36	35-927-36	35-928-36		35-930-36
38 cm	15		35-921-38	35-922-38	35-923-38	35-924-38	35-925-38	35-926-38	35-927-38	35-928-38	35-929-38	35-930-38
40 cm	15¾		35-921-40	35-922-40	35-923-40	35-924-40	35-925-40	35-926-40	35-927-40	35-928-40	35-929-40	35-930-40
42 cm	16½			35-922-42	35-923-42	35-924-42	35-925-42	35-926-42	35-927-42	35-928-42	35-929-42	35-930-42
44 cm	17¼			35-922-44	35-923-44	35-924-44	35-925-44	35-926-44	35-927-44	35-928-44	35-929-44	35-930-44
46 cm	18			35-922-46	35-923-46	35-924-46	35-925-46	35-926-46	35-927-46	35-928-46	35-929-46	35-930-46
48 cm	19			35-922-48	35-923-48	35-924-48	35-925-48	35-926-48	35-927-48	35-928-48	35-929-48	35-930-48
50 cm	19¾			35-922-50	35-923-50	35-924-50	35-925-50	35-926-50	35-927-50	35-928-50	35-929-50	35-930-50
52 cm	20½				35-923-52	35-924-52	35-925-52	35-926-52	35-927-52	35-928-52	35-929-52	35-929-52

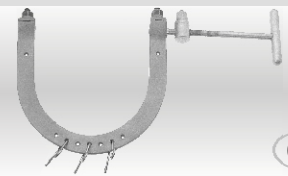

With 1 eye, ,ot 1 Öse, con 1 oja, avec 1 oeillet, con 1 foro



Length Länge Largo Longueur Lunghezza	cm in	Fig. 1	Fig. 2	Fig. 3	Fig. 4	Fig. 5	Fig. 6	Fig. 7	Fig. 8	Fig. 9
		ø 6 mm	ø 7 mm	ø 8 mm	ø 9 mm	ø 10 mm	ø 11 mm	ø 12 mm	ø 13 mm	ø 14 mm
18 cm	7	35-940-18	35-941-18	35-942-18	35-943-18	35-944-18	35-945-18			
19 cm	7½		35-941-19	35-942-19	35-943-19	35-944-19	35-945-19			
20 cm	8	35-940-20	35-941-20	35-942-20	35-943-20	35-944-20	35-945-20			
21 cm	8¼		35-941-21	35-942-21	35-943-21	35-944-21	35-945-21			
22 cm	8½	35-940-22	35-941-22	35-942-22	35-943-22	35-944-22	35-945-22			
23 cm	9		35-941-23	35-942-23	35-943-23	35-944-23	35-945-23			
24 cm	9½	35-940-24	35-941-24	35-942-24	35-943-24	35-944-24	35-945-24	35-946-24		
25 cm	10		35-941-25	35-942-25	35-943-25	35-944-25	35-945-25	35-946-25		
26 cm	10¼	35-940-26	35-941-26	35-942-26	35-943-26	35-944-26	35-945-26	35-946-26		
27 cm	10¾		35-941-27	35-942-27	35-943-27	35-944-27	35-945-27	35-946-27	35-947-27	
28 cm	11	35-940-28	35-941-28	35-942-28	35-943-28	35-944-28	35-945-28	35-946-28	35-947-28	
29 cm	11½		35-941-29	35-942-29	35-943-29	35-944-29	35-945-29	35-946-29	35-947-29	
30 cm	12	35-940-30	35-941-30	35-942-30	35-943-30	35-944-30	35-945-30	35-946-30	35-947-30	35-948-30
31 cm	12¼		35-941-31	35-942-31	35-943-31	35-944-31	35-945-31	35-946-31	35-947-31	35-948-31
32 cm	12½		35-941-32	35-942-32	35-943-32	35-944-32	35-945-32	35-946-32	35-947-32	35-948-32
33 cm	13		35-941-33	35-942-33	35-943-33	35-944-33	35-945-33	35-946-33	35-947-33	35-948-33
34 cm	13½		35-941-34	35-942-34	35-943-34	35-944-34	35-945-34	35-946-34	35-947-34	35-948-34
35 cm	13¾		35-941-35	35-942-35	35-943-35	35-944-35	35-945-35	35-946-35	35-947-35	35-948-35
36 cm	14		35-941-36	35-942-36	35-943-36	35-944-36	35-945-36	35-946-36	35-947-36	35-948-36
37 cm	14½		35-941-37	35-942-37	35-943-37	35-944-37	35-945-37	35-946-37	35-947-37	35-948-37
38 cm	15		35-941-38	35-942-38	35-943-38	35-944-38	35-945-38	35-946-38	35-947-38	35-948-38
39 cm	15½		35-941-39	35-942-39	35-943-39	35-944-39	35-945-39	35-946-39	35-947-39	35-948-39
40 cm	15¾		35-941-40	35-942-40	35-943-40	35-944-40	35-945-40	35-946-40	35-947-40	35-948-40



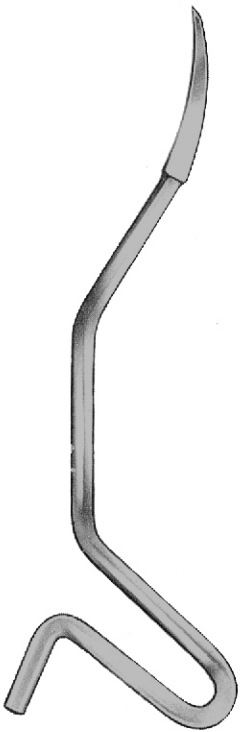
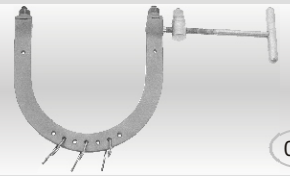

**KUNTSCHER**  
 35-950-08 08 mm  
 35-950-10 10 mm

**Reamers for medullary  
 cave**

Vorböhrer zum Öffnen  
 der Markhöhle

Perforadores para la  
 cavidad medúlar

Trépanns pour l'ouverture  
 de la cavité à moelle

Alesatore per l'apertura  
 del midollo

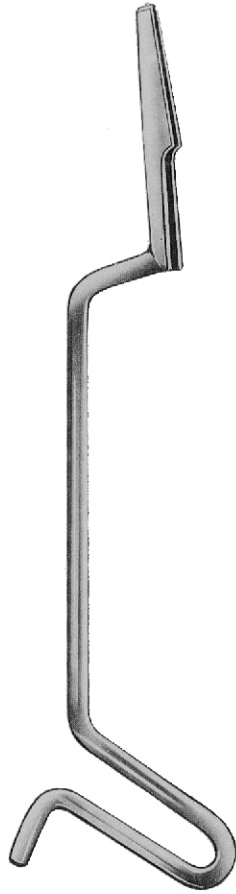

**KUNTSCHER**  
 35-952-00

**Reamer for femur**  
 Aufreiber für Oberschenkel  
 Perforador para fémur  
 Dilatateur pour fémur  
 Alesatore per femore



35-956-30  
 ø 3,0 mm  
 35-956-35  
 ø 3,5 mm  
 35-956-40  
 ø 4,0 mm  
 35-956-50  
 ø 5,0 mm

**Guide pins**

Führungsspieße

Guia-conductoras para  
 clavos medulares

Pointe-guides

Guida

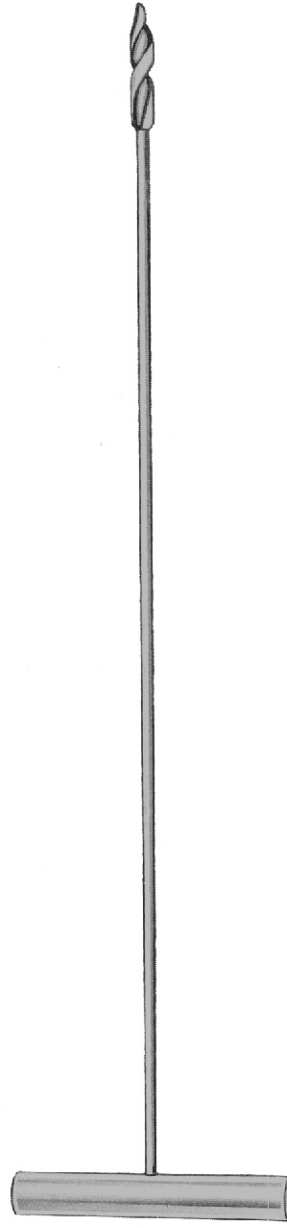

ø mm		ø mm	
06	35-960-06	14	35-960-14
07	35-960-07	15	35-960-15
08	35-960-08	16	35-960-16
09	35-960-09	17	35-960-17
10	35-960-10	18	35-960-18
11	35-960-11	19	35-960-19
12	35-960-12	20	35-960-20
13	35-960-13		

**Intramedullary drills**

Markraumböhrer  
 Perforadores medulares  
 Trépanns médullaires  
 Punta intramidollare

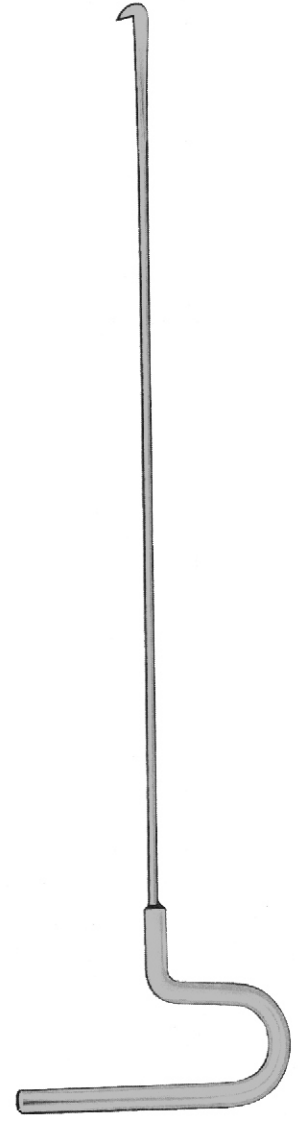

ø mm			
29	35-962-29	29 cm, 11½"	
37	35-962-37	37 cm, 14½"	
43	35-962-43	43 cm, 17"	
51	35-962-51	51 cm, 20"	

**Extraction hooks**

Extraktionschaken  
 Ganchos extractores  
 Crochets d'extraction  
 Gancio d'estrazione

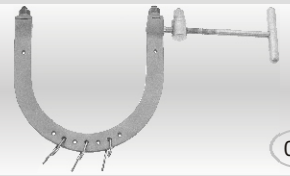

½

**SCHLITZHAMMER**

35-970-29  
 29 cm, 11½"

Slotted hammer  
 Schlitzhammer  
 Martello con ranura  
 Marteau avec fente  
 Martello con fessura

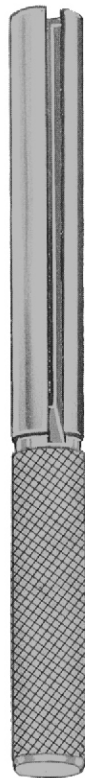

½

**VARSCHLAGER**

35-972-20  
 20 cm, 8"

Nail driver  
 Vorschläger  
 Impactor  
 Impacteur  
 Impattatore



½

**FERTIGSCHLAGER**

35-976-01 8mm  
 35-976-02 12mm  
 35-976-03 17mm  
 19 cm, 7½"

Nail impactors  
 Fertigschläger  
 Impactor final  
 Impacteurs finaux  
 Impattatore finale

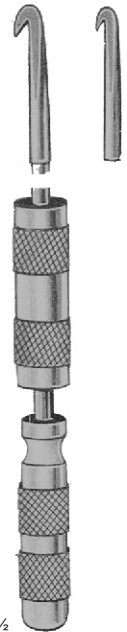

½

**35-978-29**

Nail extractor with 2 hooks  
 Extraktor mit 2 Haken  
 Aparato extractor con 2 ganchos  
 Extracteur avec 2 crochets  
 Estrattore con 2 ganci