

039

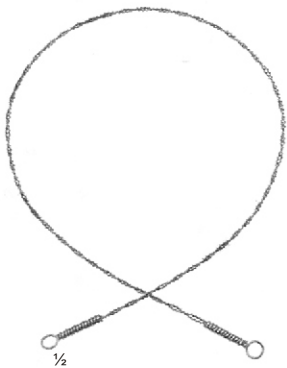

Neurosurgery and Laminectomy
Neurochirurgie und Laminektomie
Neurocirugía y Laminectomía
Neurochirurgie et Laminectomie
Neurochirurgia e Laminectomia

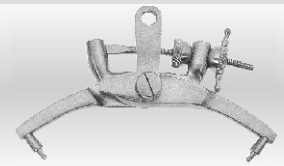

OLIVECRONA(GIGLI)

- 39-110-25 25 cm, 10"
- 39-110-30 30 cm, 12"
- 39-110-40 40 cm, 16"
- 39-110-50 50 cm, 20"
- 39-110-60 60 cm, 24"
- 39-110-70 70 cm, 28"

Wire saws
 Drahtsägen
 Sierras de hilo
 Fils-scies
 Fili per sega



39-112-01



39-112-02



39-112-03

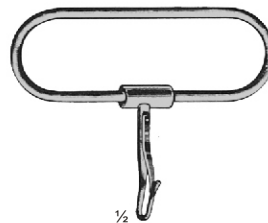

39-112-04

GIGLI
 39-112-01
 39-112-04

Hook handles for wire saws
 Handgriffe für Drahtsägen
 Mango con gancho, para sierras de hilo
 Poignées pour scies
 Manico ad uncino per fili per sega



DE MARTEL
 39-114-33
 33 cm, 13"

Conductor for wire saws
 Einführungsinstrument für Drahtsägen
 Conductor para sierras de hilo
 Conducteur pour scies
 Guida per fili per sega

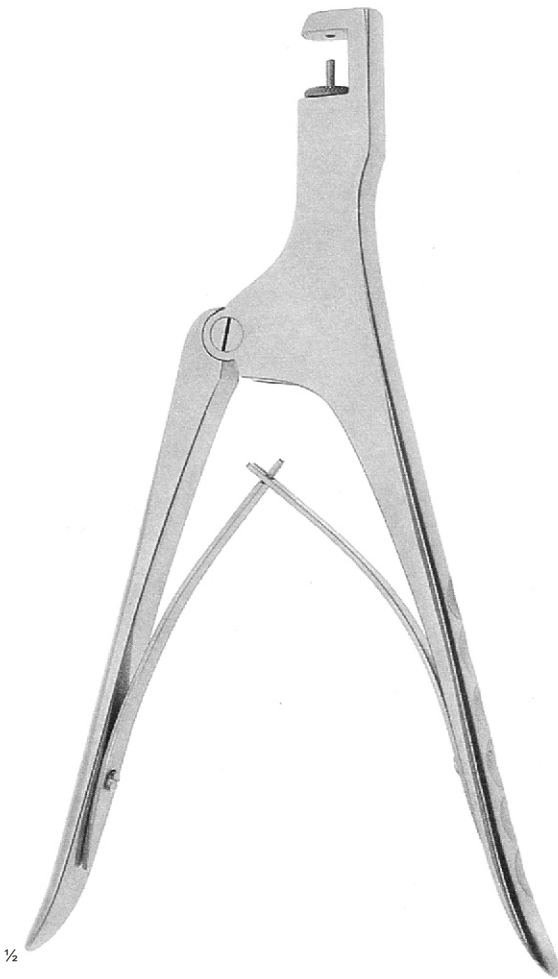
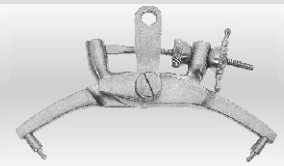

CONE
 39-120-23
 23 cm, 9"

Cranial punch rongeur for maximum of 12 mm of bone

Schädelstanzzange bis 12 mm Schädelstärke

Pinza saca-bocados craneal para craneo hasta 12 mm

Pince crâniene jusqu'à 12 mm épaisness du crâne

Pinza per cranio, asta 12 mm



39-122-01

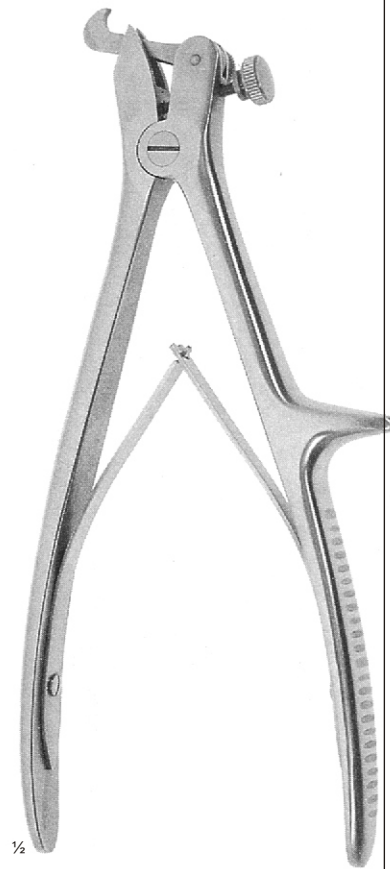

DAHLGREN
 39-122-20
 20 cm, 8"

Cranial rongeur with 2 hooks (39-122-01)

Schädelstanze mit 2 Haken (39-122-01)

Pinza saca-bocado craneal con 2 ganchos (39-122-01)

Rongeur crâniens avec 2 crochets (39-122-01)

Pinza per cranio con 2 genci (39-122-01)

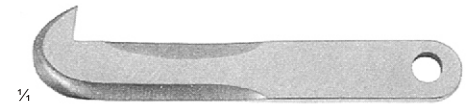

39-124-01

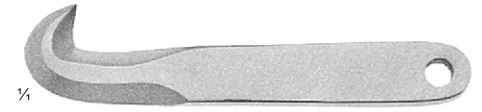

39-124-02



DE VILBISS
 39-124-21
 21 cm, 8 1/4"

Cranial rongeur with 1 hook each small (39-124-01) and large (39-124-02)

Schädelstanze mit je 1 Haken klein (39-124-01) und groß (39-124-02)

Pinza saca-bocado craneal con 1 gancho pequeño (39-124-01) y grande (39-124-02)

Rongeur crâniens avec 1 crochet petit (39-124-01) et grand (39-124-02)

Pinza per cranio con 1 gancio piccolo (39-124-01) e 1 grande (39-124-02)

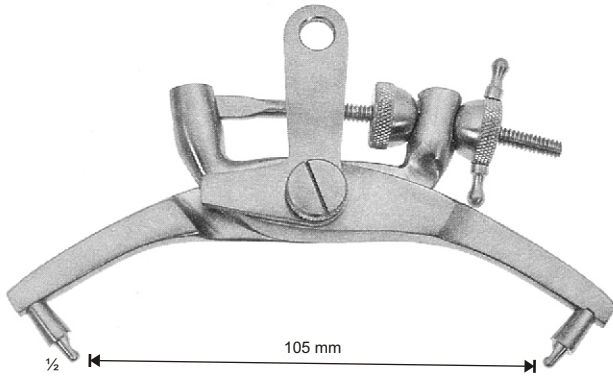
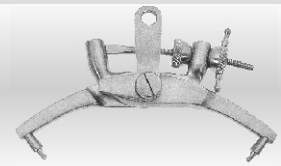

CRUTCHFIELD
 39-130-10

Cervical traction tongs, small size
 Schädelhalter, kleine Größe
 Pinza de tracción craneal, tamaño pequeño
 Etrier traction crânienne, petit modèle
 Pinza per trazione craniale, modello piccolo

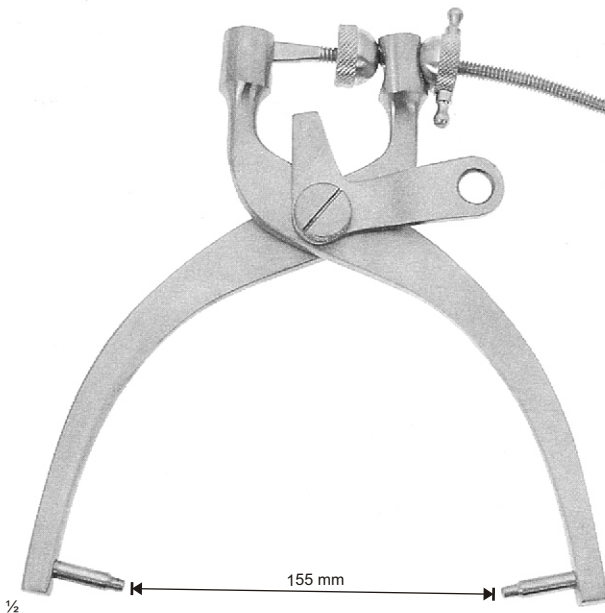

CRUTCHFIELD
 39-136-15

Cervical traction tongs, medium size
 Schädelhalter, Mittlere Größe
 Pinza de tracción craneal, tamaño mediano
 Etrier traction crânienne, modèle moyen
 Pinza per trazione craniale, modello medio



CRUTCHFIELD
 39-134-01
 3,5 mm ø



CRUTCHFIELD
 39-134-02
 5 mm ø



39-138-17

Cervical traction tongs, for extension of the neck vertebrae, large size, pins adjustable hence no initial drilling

Schädelhalter für Extension der Halswirbel, großes Modell, Dorne verstellbar, deshalb Vorbohren nicht erforderlich

Pinza de tracción craneal para la extensión de las vértebras de cuello, tamaño grande, puntas ajustables, suprimiendo perforaciones iniciales

Etrier traction crânienne, pour l'extension des vérèbres cervicales, grand modèle, mandrins réglables supprimant la perforation initiale

Pinza per trazione craniale e l'estensione delle vertebre del collo, modello grande, punte regolabili al fine di evitare la perforazione iniziale

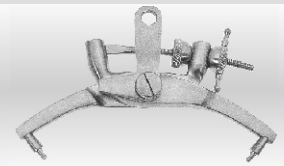

1/2

RANEY
 39-140-16
 16 cm, 6 1/2"

Applying and removing forceps for scalp hemostasis clips

Anlege- und Abnehmzange für Kopfhautklammern

Pinza para aplicar y quitar clips hemostáticas de cuero cabelludo

Pince pour poser et retirer les clips hémostatiques du cuir chevelu

Pinza per applicare e togliere le agrafo emostatiche al cuoio capelluto



MOD. KÖLN
 39-142-01

Scalp hemostasis clips, in packages of 10 pieces

Kopfhautklammern, in Packungens zu 10 Stück

Pinza hemostática para cuero cabelludo, en paquetes de 10 piezas

Agrafes hémostatiques pour cuir chevelu en paquets de 10 pièces

Agrafes emostatici per cuoio capelluto, in confezioni da 10 pezzi



RANEY
 39-142-02

Scalp hemostasis clips, in packages of 12 pieces

Kopfhautklammern, in Packungens zu 12 Stück

Pinza hemostática para cuero cabelludo, en paquetes de 12 piezas

Agrafes hémostatiques pour cuir chevelu en paquets de 12 pièces

Agrafes emostatici per cuoio capelluto, in confezioni da 12 pezzi



1/4



39-144-00

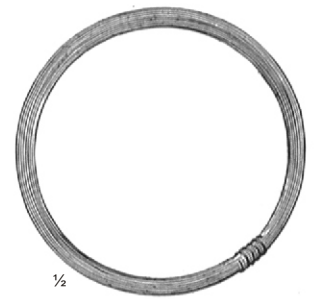

1/2

McKENZIE
 39-146-00

Silver wire in coils of 2,5 g.

Silberdraht zur Herstellung von Klammern, Ringen zu 2,5 gr.

Hilo de plata para producir grapas, en rollos de 2,5 gr.

Fil d'argent pour fabriquer des agrafes par rouleaux de 2,5 g

Filo di argento per la costruzione di agrafo in rotoli de gr. 2,5

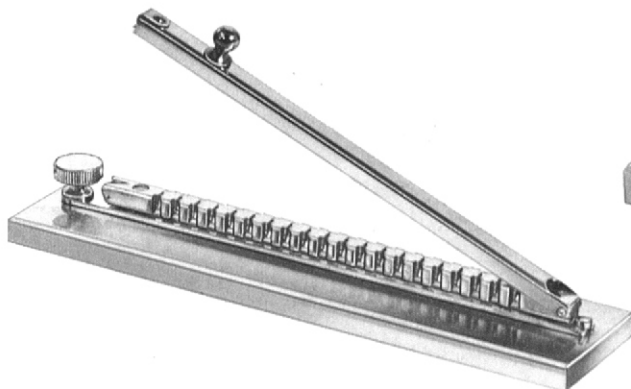

39-150-01
 148 x 40 x 6 mm (5 3/4 x 1 1/2 x 1/4)"

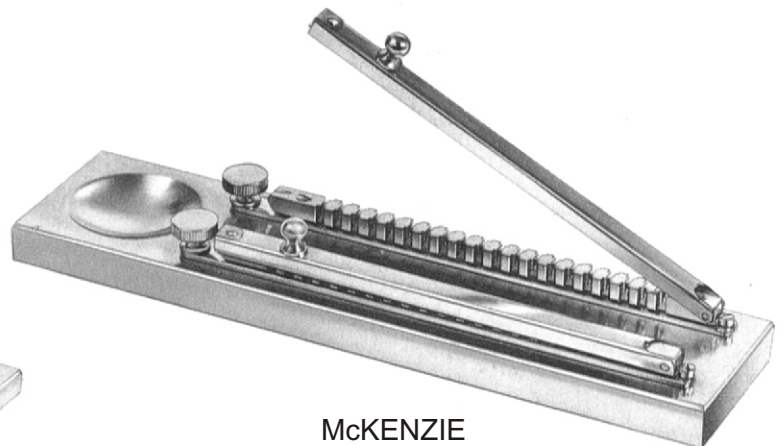

McKENZIE
 39-150-02
 190 x 48 x 13 mm (7 1/2 x 2 x 1/2)"

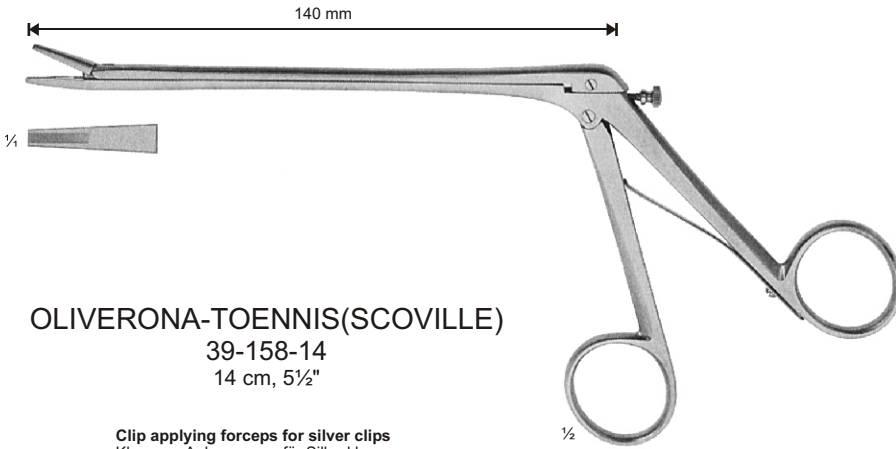
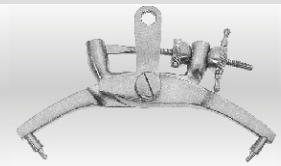

OLIVERONA-TOENNIS(SCOVILLE)
 39-158-14
 14 cm, 5½"

Clip applying forceps for silver clips
 Klammer-Anlegezange für Silberklammern
 Pinza para colocar las grapas de plata
 Pinça pose clips
 Pinza metti agrafes per agrafes in argento

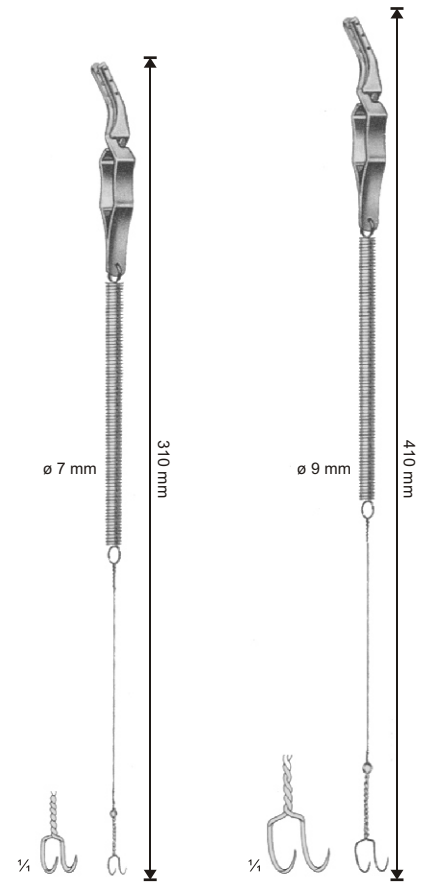
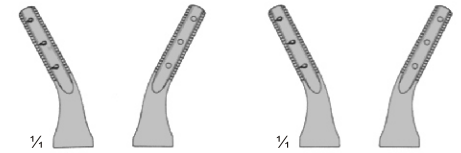

YASARGIL
 39-164-31
 31 cm, 12¼"

YASARGIL
 39-164-41
 41 cm, 16"

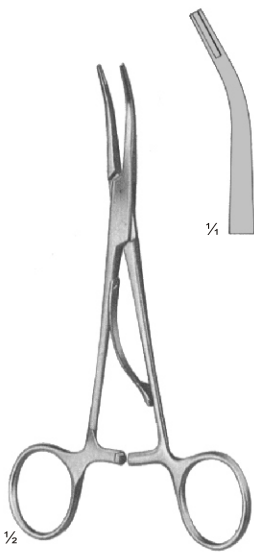

McKENZIE
 39-158-15 15 cm, 6"
 39-158-19 19 cm, 7½"

Clip applying forceps for silver clips
 Klammer-Anlegezange für Silberklammern
 Pinza para colocar las grapas de plata
 Pinça pose clips
 Pinza metti agrafes per agrafes in argento

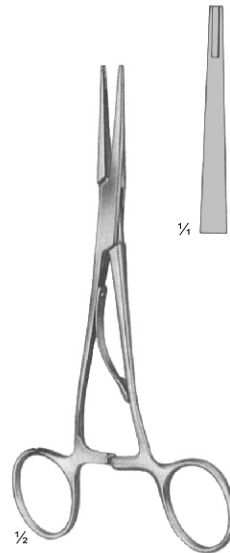

McKENZIE
 39-159-15 15 cm, 6"
 39-159-19 19 cm, 7½"

Clip applying forceps for silver clips
 Klammer-Anlegezange für Silberklammern
 Pinza para colocar las grapas de plata
 Pinça pose clips
 Pinza metti agrafes per agrafes in argento

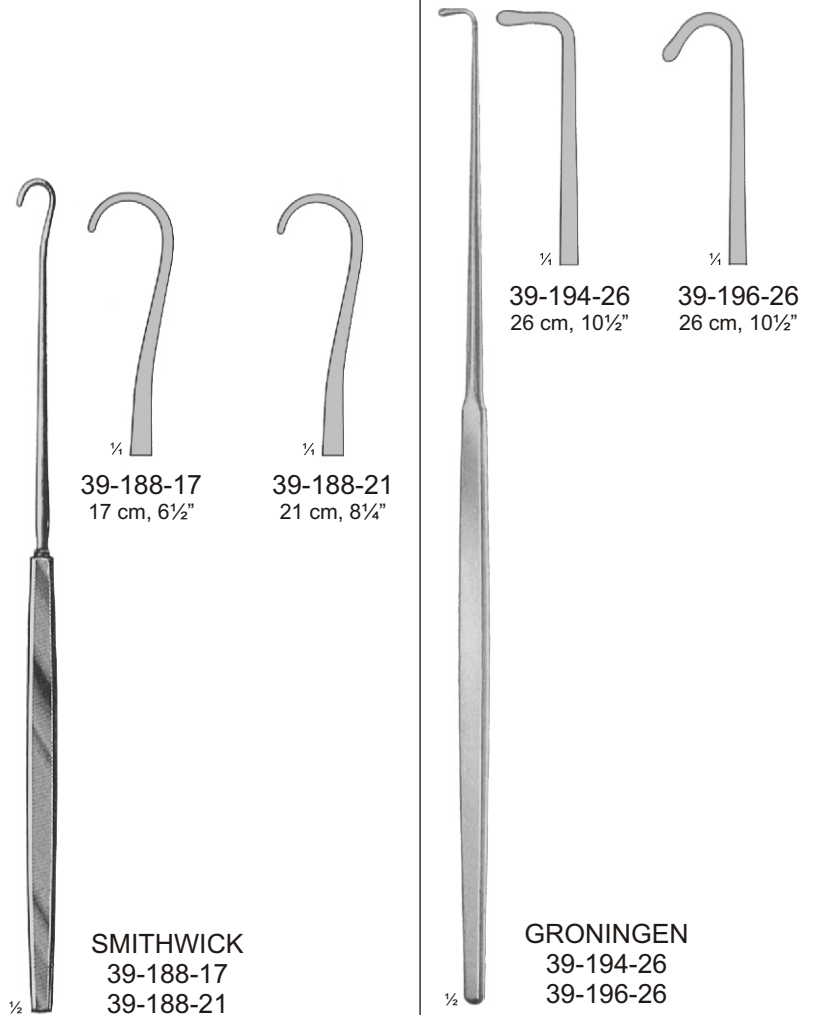
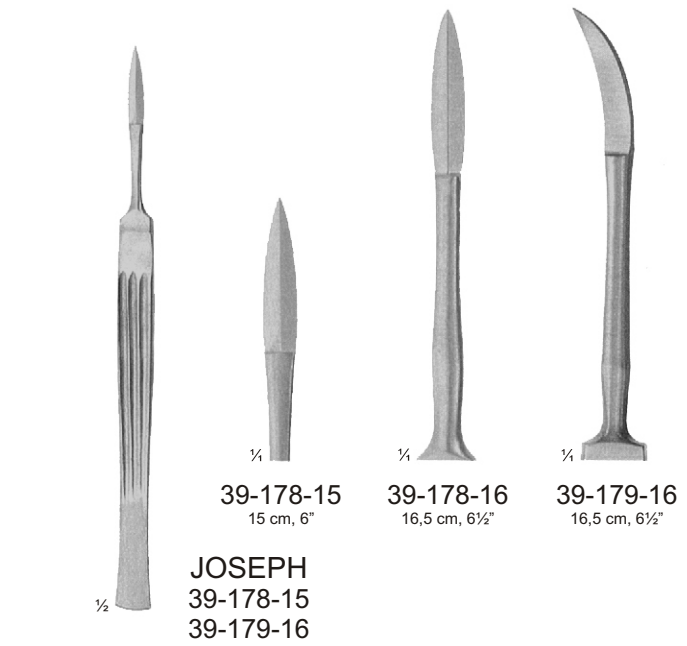
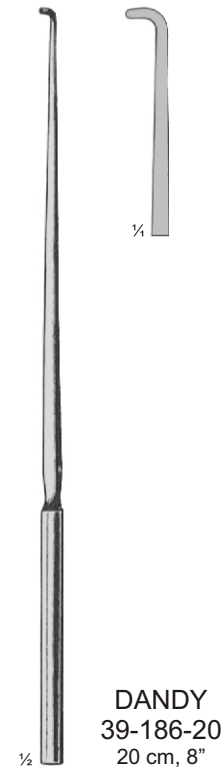
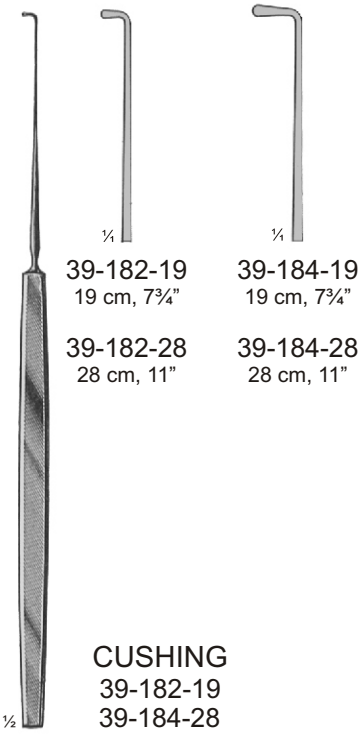
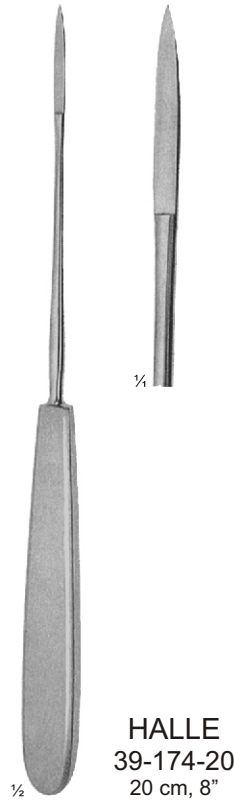
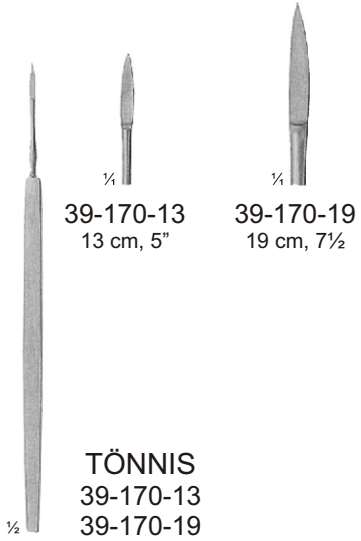



Nerve Retractors, Knives
Nervhaken, Messer
Separadores de nervios, Bistruíes
Crochets à nerfs, Bistouris



039

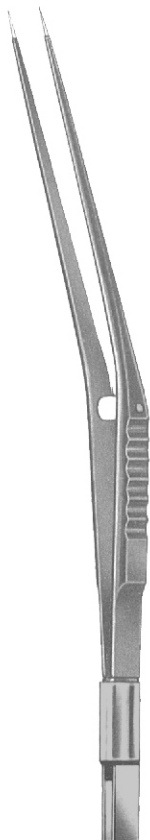
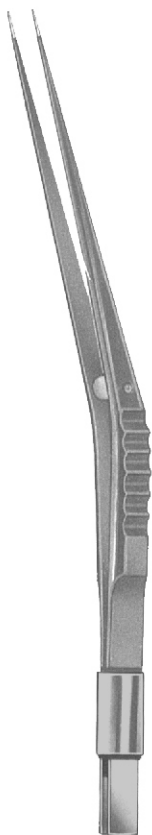
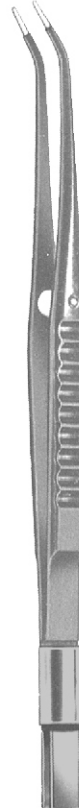



Nerve Retractors, Knives
Nervhaken, Messer
Separadores de nervios, Bistruíes
Crochets à nerfs, Bistouris



039

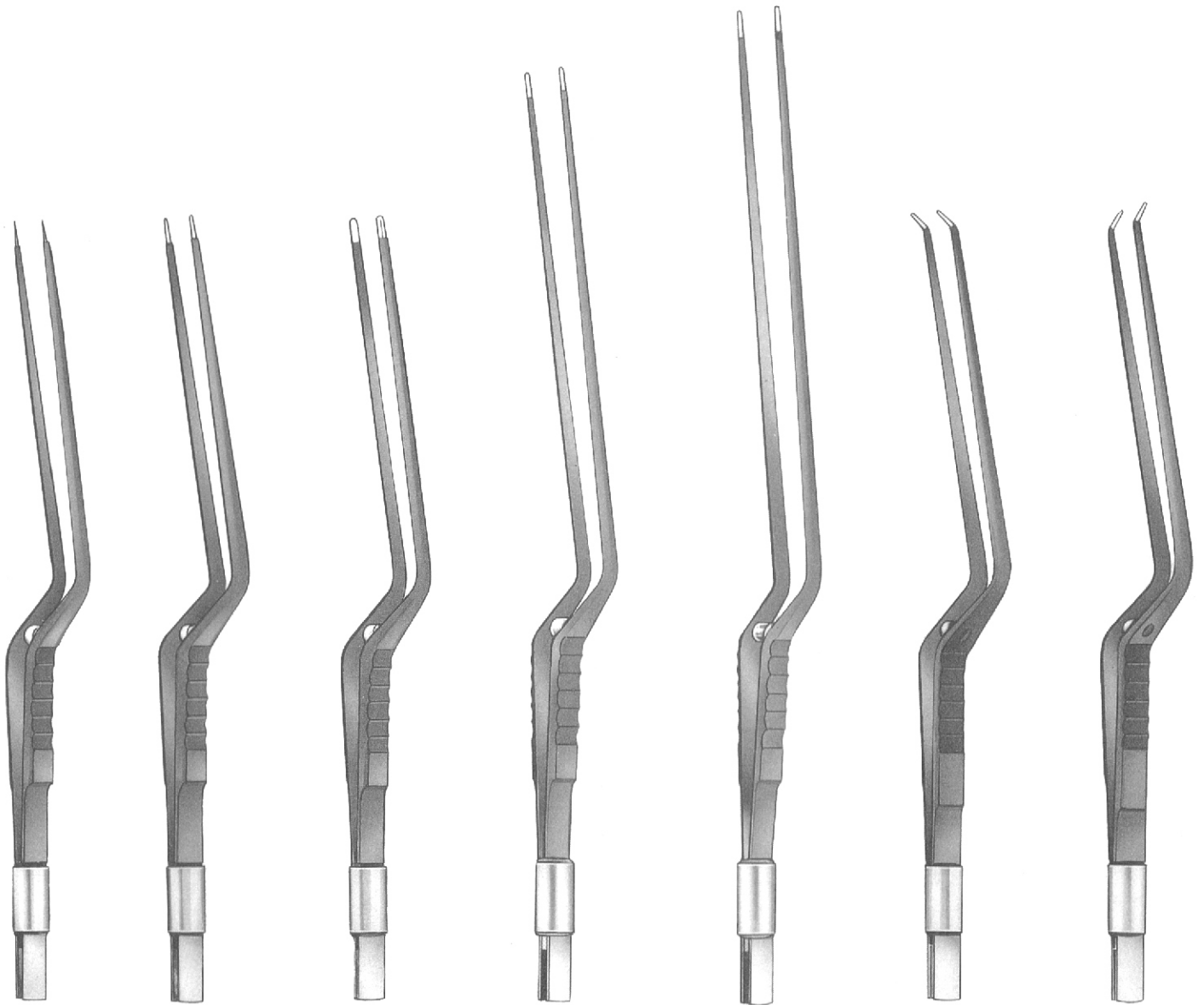
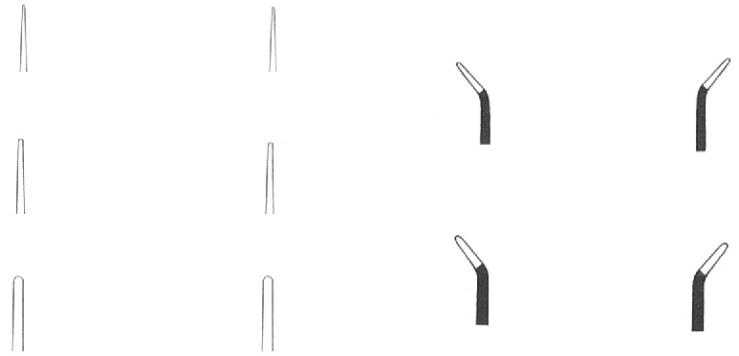

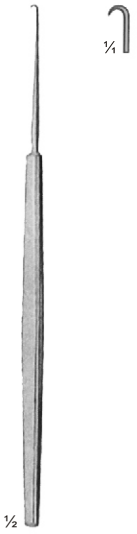

CUSHING
 39-242-14
 14 cm, 5½"



FRAZIER
 39-244-13
 39-244-18



39-244-13
 13 cm, 5"



39-244-18
 18 cm, 7"



GRAHAM
 39-246-16
 16,5 cm, 6½"



SACHS
 39-248-18
 18,5 cm, 7¼"

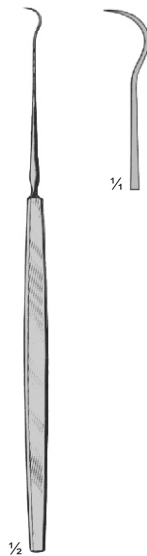

TOENNIS
 39-250-15
 15 cm, 6"



CUSHING
 39-252-20
 20 cm, 8"



ADSON
 39-254-20
 20 cm, 8"



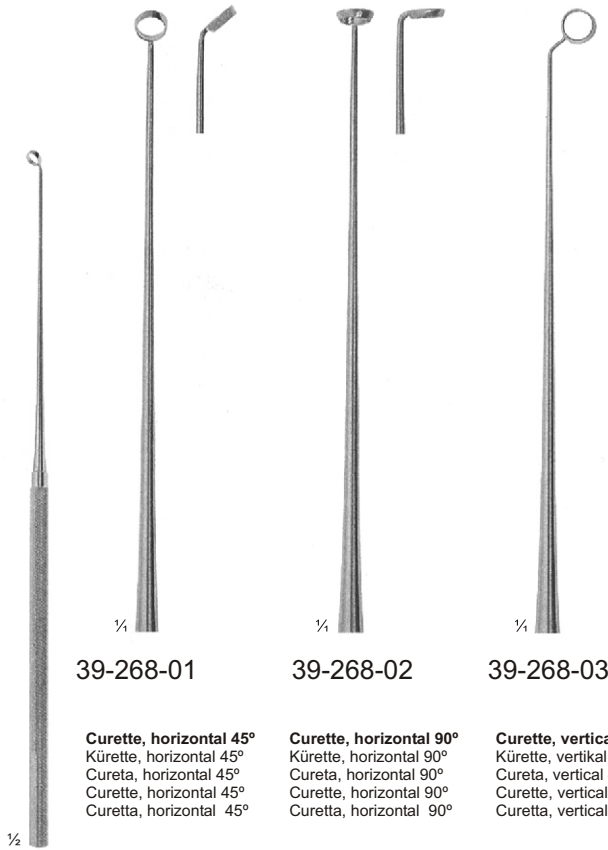

39-268-01

39-268-02

39-268-03

Curette, horizontal 45°
 Kürette, horizontal 45°
 Cureta, horizontal 45°
 Curette, horizontal 45°
 Curetta, horizontal 45°

Curette, horizontal 90°
 Kürette, horizontal 90°
 Cureta, horizontal 90°
 Curette, horizontal 90°
 Curetta, horizontal 90°

Curette, vertical 45°
 Kürette, vertikal 45°
 Cureta, vertical 45°
 Curette, verticale 45°
 Curetta, verticale 45°

RAY
 39-268-01
 39-268-03
 18,5 cm, 7¼"



39-269-01

39-269-02

Curette, horizontal 90°, malleable

Kürette, horizontal 90°, biegsam

Cureta horizontal 90°, maleable

Curette horizontale 90°, malléable

Curetta orizzontale 90°, malleabile

Curette, horizontal 90°, malleable

Kürette, horizontal 90°, biegsam

Cureta horizontal 90°, maleable

Curette horizontale 90°, malléable

Curetta orizzontale 90°, malleabile

HARDY
 39-269-01
 39-269-02
 26 cm, 10¼"

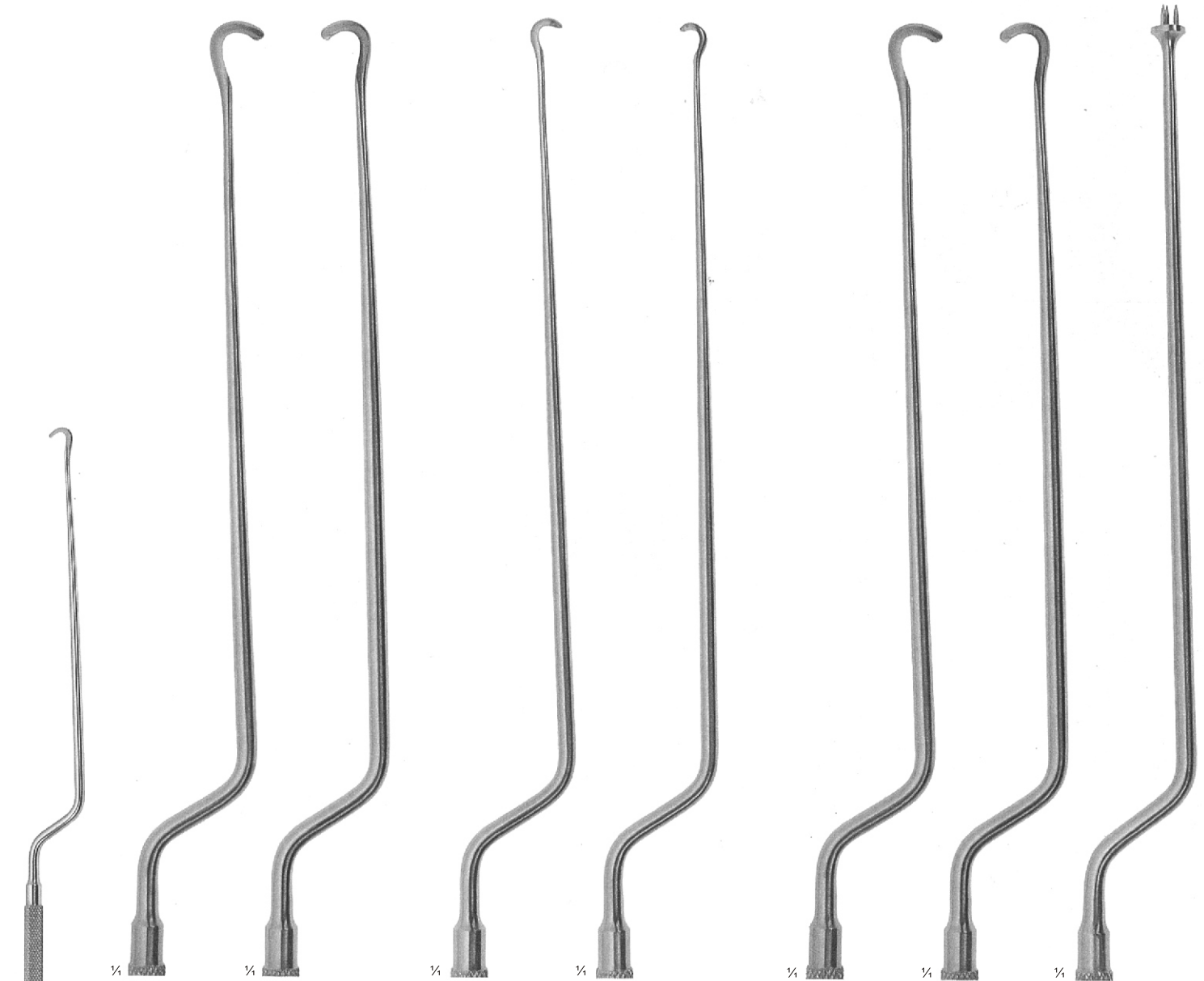

HARDY
39-270-01

HARDY
39-270-02

HARDY
39-270-03

HARDY
39-270-04

HARDY
39-270-05

HARDY
39-270-06

HARDY
39-270-07

Enucleators, blunt
 Enucleatoren, stumpf
 Enucleadores, romos
 Enucleateurs, moussu
 Enucleatore, smusso

Dissectors, sharpended inner edge
 Dissektoren, innen scharf
 Disectores, agudos en el interior
 Dissecteur, pointus à l'intérieur
 Dissettori, bordo interno acuto

Dissectors, sharpended inner edge
 Dissektoren, innen scharf
 Disectores, agudos en el interior
 Dissecteur, pointus à l'intérieur
 Dissettori, bordo interno acuto

Implant fork
 Implantations-gabel
 Horquilla para implantar
 Fourchetto pour implants
 Forchetta per implantare

39-270-01
 39-270-07
 24,5 cm, 9³/₄"



Vessel knife
 Gefäßmesser
 Cuchillo para vasos
 Couteau pour vaisseaux
 Bisturi per vasi

Lateral cutting edge
 Schneide seitlich
 Filo de corte lateral
 Tranchant latéral
 Taglio laterale

39-271-01
 39-273-18
 19 cm, 7½"

1/4 KOOS
 39-271-01

1/4 KOOS
 39-271-02

1/4 KOOS
 39-271-03

1/4 KOOS
 39-271-04

1/4 KRAUS
 39-273-18

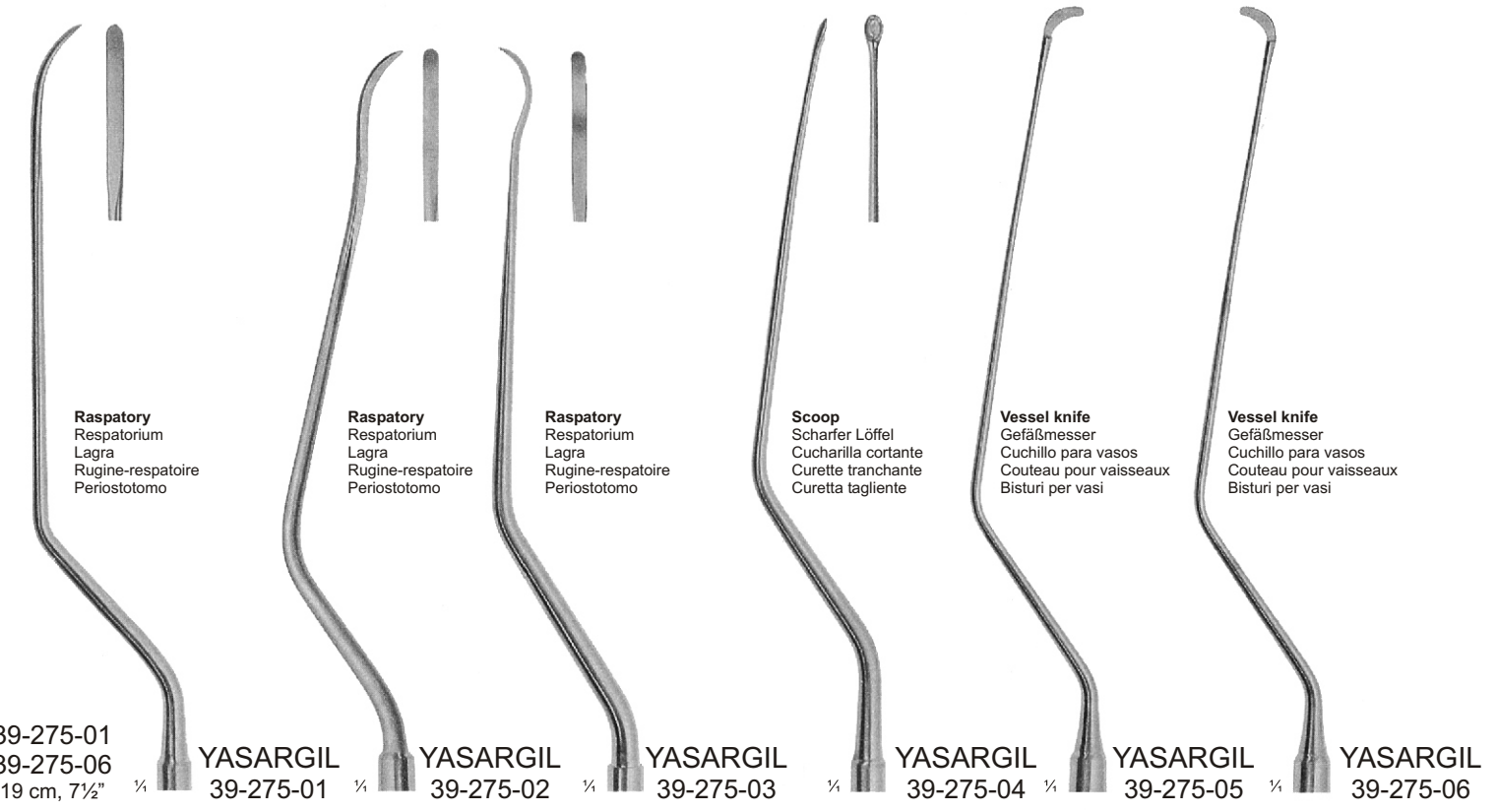

Raspatory
 Resporatorium
 Lagra
 Rugine-respatoire
 Periototomo

Raspatory
 Resporatorium
 Lagra
 Rugine-respatoire
 Periototomo

Raspatory
 Resporatorium
 Lagra
 Rugine-respatoire
 Periototomo

Scoop
 Scharfer Löffel
 Cucharilla cortante
 Curette tranchante
 Curetta tagliente

Vessel knife
 Gefäßmesser
 Cuchillo para vasos
 Couteau pour vaisseaux
 Bisturi per vasi

Vessel knife
 Gefäßmesser
 Cuchillo para vasos
 Couteau pour vaisseaux
 Bisturi per vasi

39-275-01
 39-275-06
 19 cm, 7½"

1/4 YASARGIL
 39-275-01

1/4 YASARGIL
 39-275-02

1/4 YASARGIL
 39-275-03

1/4 YASARGIL
 39-275-04

1/4 YASARGIL
 39-275-05

1/4 YASARGIL
 39-275-06



Vessel knife
 Gefäßmesser
 Cuchillo para vasos
 Couteau pour vaisseaux
 Bisturi per vasi

Lateral cutting edge
 Schneide seitlich
 Filo de corte lateral
 Tranchant latéral
 Taglio laterale

39-271-01
 39-273-18
 19 cm, 7½"

39-271-01

39-271-02

39-271-03

39-271-04

39-273-18

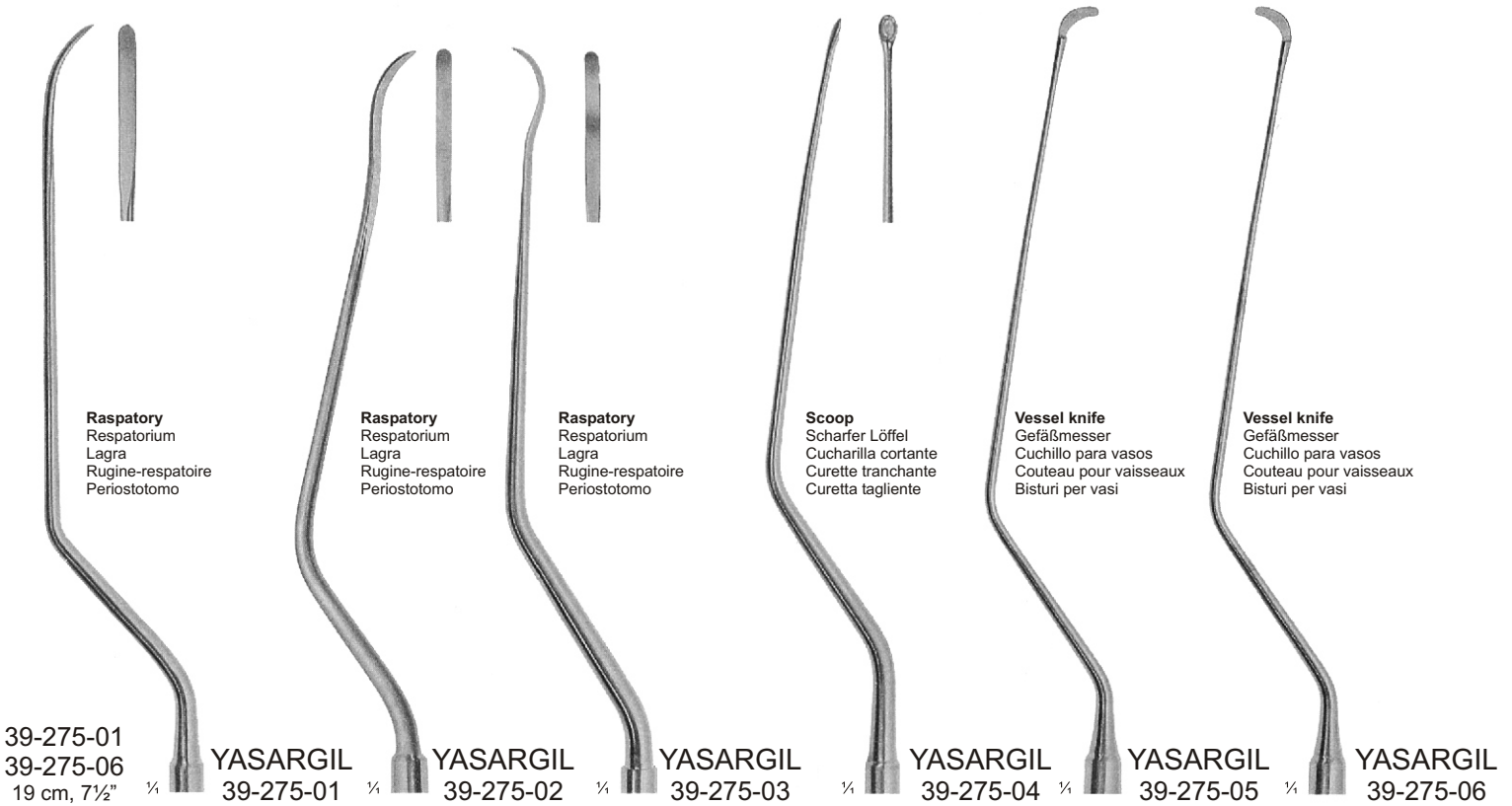

Raspatory
 Resporatorium
 Lagra
 Rugine-respatoire
 Periototomo

Raspatory
 Resporatorium
 Lagra
 Rugine-respatoire
 Periototomo

Raspatory
 Resporatorium
 Lagra
 Rugine-respatoire
 Periototomo

Scoop
 Scharfer Löffel
 Cucharilla cortante
 Curette tranchante
 Curetta tagliente

Vessel knife
 Gefäßmesser
 Cuchillo para vasos
 Couteau pour vaisseaux
 Bisturi per vasi

Vessel knife
 Gefäßmesser
 Cuchillo para vasos
 Couteau pour vaisseaux
 Bisturi per vasi

39-275-01
 39-275-06
 19 cm, 7½"

39-275-01

39-275-02

39-275-03

39-275-04

39-275-05

39-275-06



YASARGIL
 39-278-01
 19 cm, 7½"

Raspatory
 Raspatorium
 Legra
 Rugine-raspatoire
 Periostotomo



YASARGIL
 39-278-02
 19 cm, 7½"

Raspatory
 Raspatorium
 Legra
 Rugine-raspatoire
 Periostotomo



YASARGIL
 39-278-03
 19 cm, 7½"

Raspatory
 Raspatorium
 Legra
 Rugine-raspatoire
 Periostotomo



JACOBSON
 39-278-04
 19 cm, 7½"

Vessel knife
 Gefäßmesser
 Cuchillor para vasos
 Couteau pour vaisseaux
 Bisturi per vasi



JACOBSON
 39-278-05
 19 cm, 7½"

Buttoned probe
 Knopfesonde
 Sonda abotonada
 Sonde boutonée
 Sonda bottonula



39-278-01
 39-278-09



JACOBSON
 39-278-06
 19 cm, 7½"

Twin probe
 Doppelsonde
 Sonda doble
 Sonde double
 Sonda doppia



JACOBSON
 39-278-07
 19 cm, 7½"

Suture pusher
 Fadengabel
 Empujador de sutura
 Fourche à fil
 Punzone per sutura



YASARGIL
 39-278-08
 19 cm, 7½"

Raspatory
 Raspatorium
 Legra
 Rugine-raspatoire
 Periostotomo



YASARGIL
 39-278-09
 19 cm, 7½"

Dissector
 Dissector
 Dissecador
 Dissecteur
 Dissetore

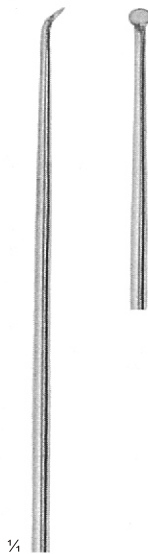

39-280-01
 23 cm, 9"
Raspatory
 Raspatorium
 Lagra
 Rugine-raspatoire
 Periostotomo



39-280-02
 23 cm, 9"
Raspatory
 Raspatorium
 Lagra
 Rugine-raspatoire
 Periostotomo

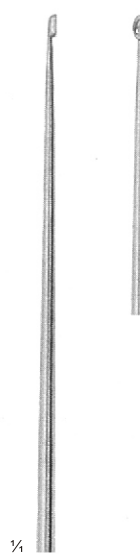

39-280-03
 23 cm, 9"
Scoop
 Scharfer Löffel
 Cuchrilla cortante
 Curette tranchante
 Curetta tagliente

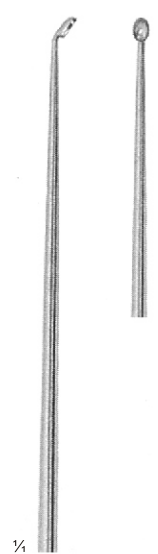

39-280-04
 23 cm, 9"
Scoop
 Scharfer Löffel
 Cuchrilla cortante
 Curette tranchante
 Curetta tagliente

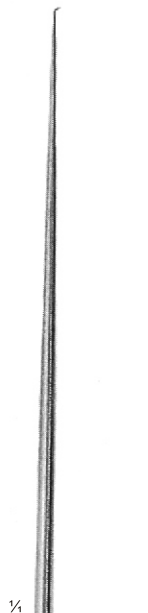

39-280-05
 23 cm, 9"
Hook
 Häkchen
 Gancho
 Crochet
 Uncino



39-280-06
 23 cm, 9"
Hook
 Häkchen
 Gancho
 Crochet
 Uncino

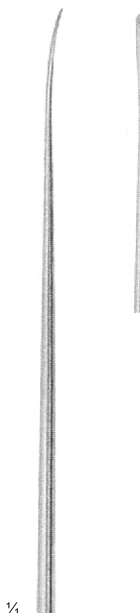

39-280-07
 23 cm, 9"
Dissector
 Dissektor
 Disecador
 Dissecteur
 Dissettore

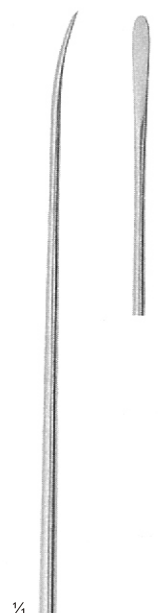

39-280-08
 23 cm, 9"
Dissector
 Dissektor
 Disecador
 Dissecteur
 Dissettore



39-280-01
 39-280-08

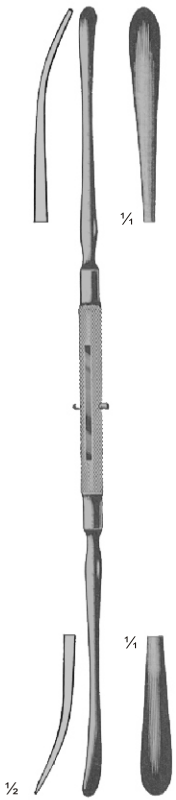

DAVIS
 39-282-24
 24,5 cm, 9 $\frac{3}{4}$ "

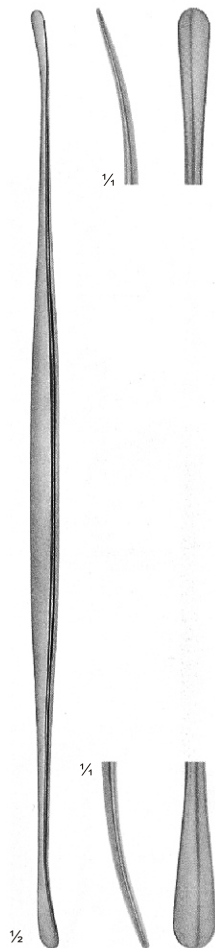

PENFIELD
 39-284-29
 29 cm, 11 $\frac{1}{2}$ "

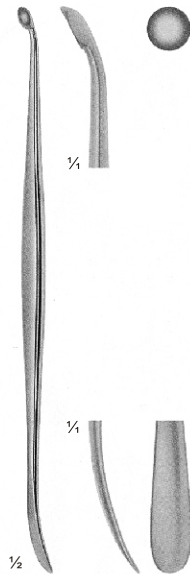

PENFIELD
 39-286-17
 17,5 cm, 7"

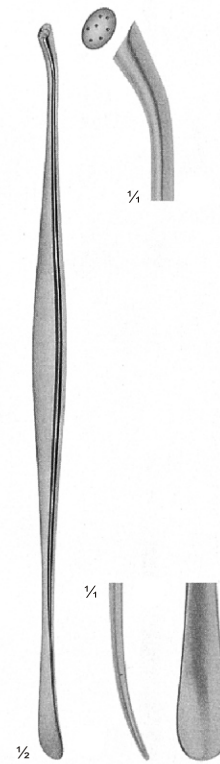

PENFIELD
 39-288-19
 19,5 cm, 7 $\frac{3}{4}$ "

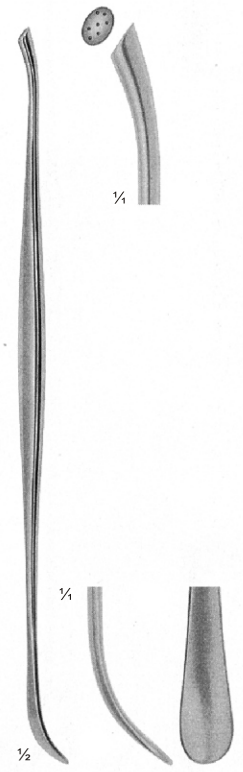

PENFIELD
 39-290-19
 19,5 cm, 7 $\frac{3}{4}$ "

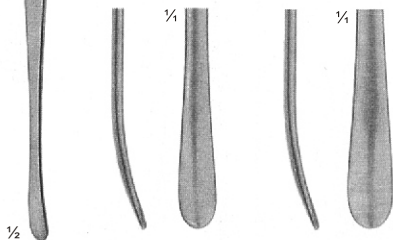
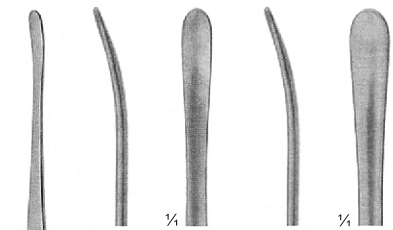

39-292-01
25 cm, 10"

39-292-02
25 cm, 10"

TOENNIS
39-292-01
39-292-02

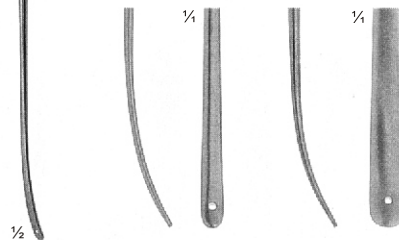
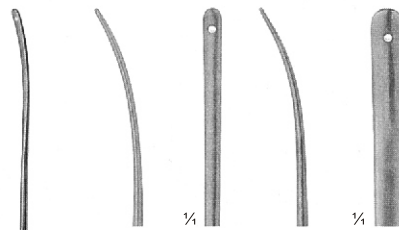

39-294-18
18 cm, 7"

39-294-24
24 cm, 9½"

OLIVECRONA
39-294-18
39-294-24

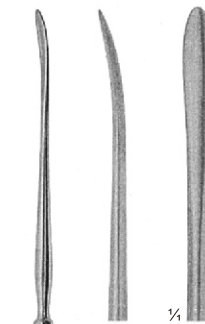

½

SACHS
39-296-21
21 cm, 8¼"

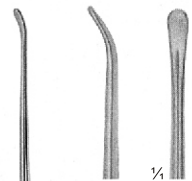

½

PENFIELD
39-298-21
21 cm, 8¼"

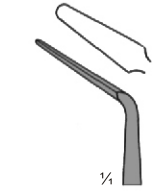
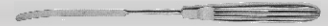

FRAZIER
 39-300-01
 15 cm, 6"

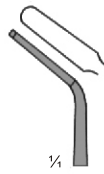

HOEN
 39-300-02
 15 cm, 6"

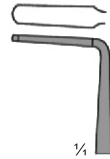

HOEN
 39-300-03
 15 cm, 6"

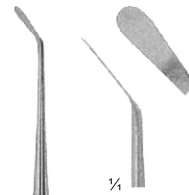

MILIGAN
 39-308-21
 21 cm, 8 1/4"

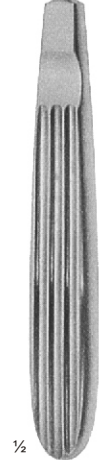
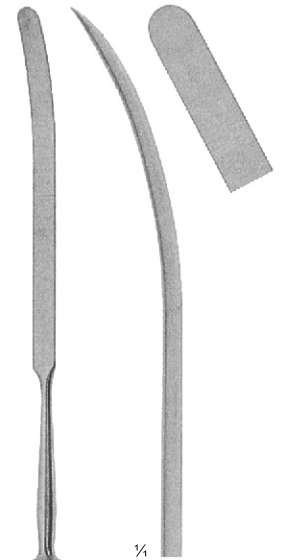

SACHS
 39-310-21
 21 cm, 8 1/4"



FRAZIER
 39-302-15
 15 cm, 6"

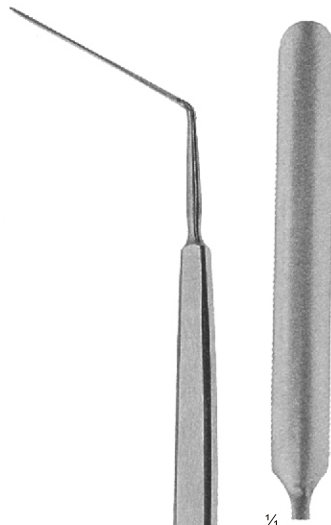

HORSLEY
 39-306-20
 20 cm, 8"

Nerve root retractors

Nervwurzelnhaken

Separadors para la raiza de nervios

Rétracteurs pour racines nerveuses

Separatori per le radici dei nervi

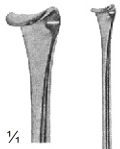
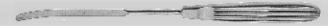

Nerve root retractor

Nervwurzelnhaken

Separador para la raiz de nervios

Rétracteur pour racines nerveuses

Separatore per le radici dei nervi

LOVE
39-340-20
20 cm, 8"

1/2

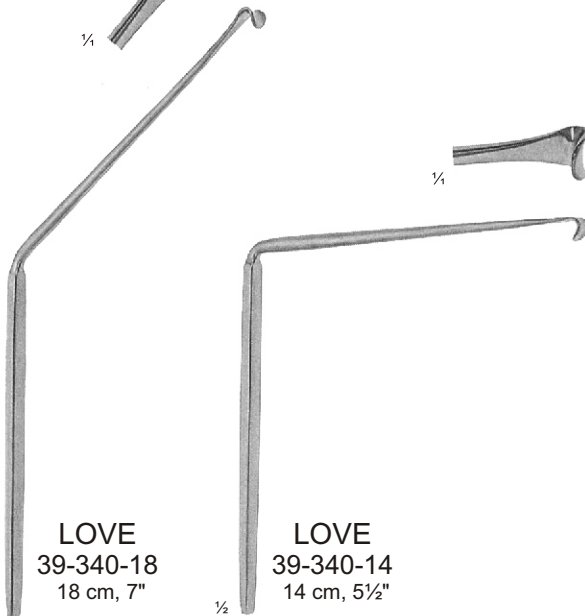

LOVE
39-340-18
18 cm, 7"

1/2



LOVE
39-340-14
14 cm, 5 1/2"

1/2

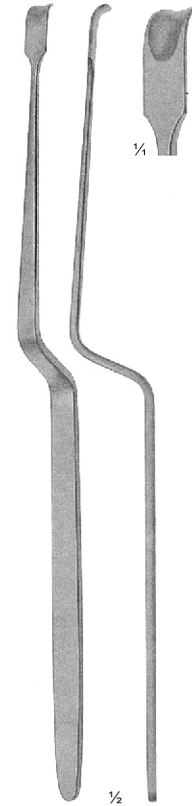

Nerve root retractor

Nervwurzelnhaken

Separador para la raiz de nervios

Rétracteur pour racines nerveuses

Separatore per le radici dei nervi

LOVE
39-345-23
23 cm, 9"

1/2

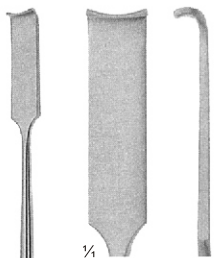

Nerve root retractor

Nervwurzelnhaken

Separador para la raiz de nervios

Rétracteur pour racines nerveuses

Separatore per le radici dei nervi

SCOVILLE
39-346-23
23 cm, 9"

1/2

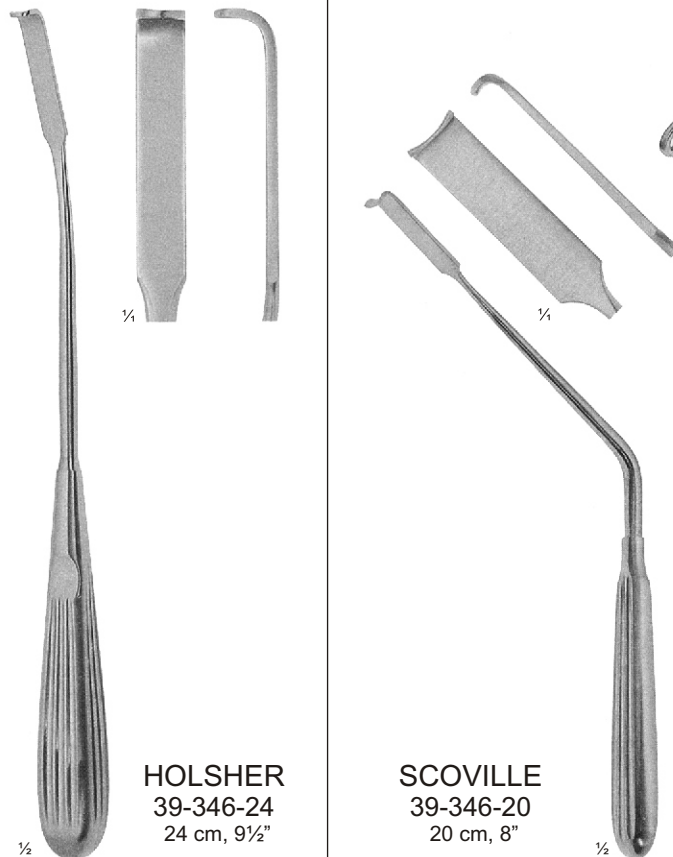

HOLSHER
39-346-24
24 cm, 9 1/2"

1/2

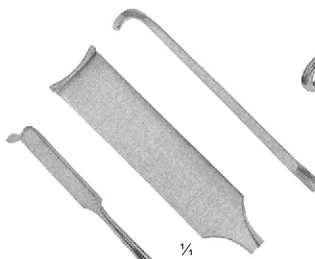

SCOVILLE
39-346-20
20 cm, 8"

1/2

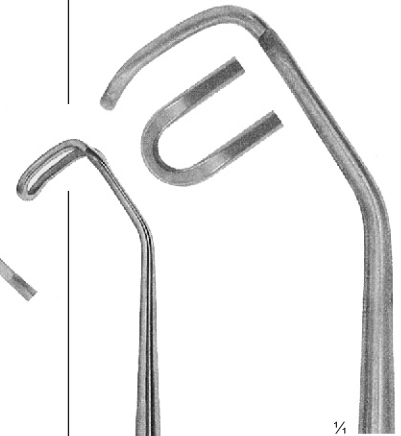

Decompression hook

Dekompressionshaken

Gancho para decompresión

Crochet pour décompression

Gancio per decompressione

CUSHING
39-348-20
20 cm, 8"

1/2

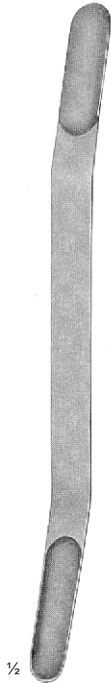

Concave
 Konkave
 Còncaves
 Concaves
 Concave

OLIVECRONA

- 39-252-01 7 + 9 mm x 180 mm
 - 39-252-02 11 + 13 mm x 180 mm
 - 39-252-03 15 + 18 mm x 180 mm
 - 39-252-04 18 + 22 mm x 180 mm
- 18 cm, 7"



Convex
 Konvex
 Cònvexas
 Convexes
 Convessa

OLIVECRONA

- 39-350-01 7 + 9 mm x 180 mm
 - 39-350-02 11 + 13 mm x 180 mm
 - 39-350-03 15 + 18 mm x 180 mm
 - 39-350-04 18 + 21 mm x 180 mm
- 18 cm, 7"



Malleable
 Biegsam
 Maleables
 Malléables
 Malleabili

DAVIS

- 39-355-01 13 mm x 190 mm
 - 39-355-02 16 mm x 190 mm
- 18 cm, 7"



- CUSHING**
 39-356-01
 10 + 12 mm x 195 mm



Malleable
 Biegsam
 Maleables
 Malléables
 Malleabili

HEIFETZ

- 39-357-01 8 mm x 155 mm
- 39-357-02 11 mm x 155 mm
- 39-357-03 14 mm x 155 mm
- 39-357-04 17 mm x 155 mm



Malleable
 Biegsam
 Maleables
 Malléables
 Malleabili

HEIFETZ

- 39-359-01 14 mm x 200 mm
 - 39-359-02 17 mm x 200 mm
 - 39-359-03 20 mm x 200 mm
- 18 cm, 7"

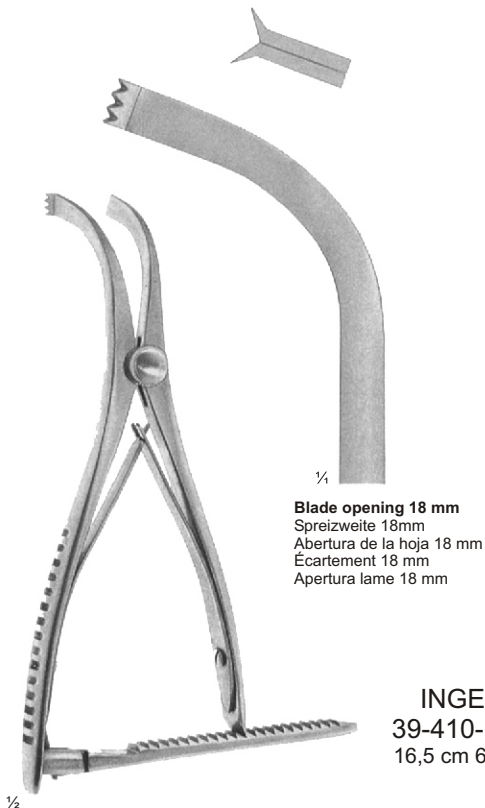
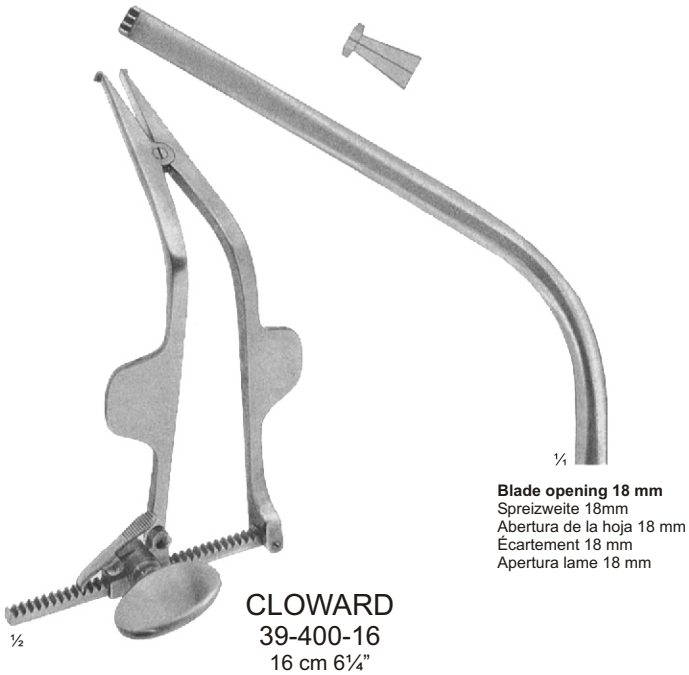

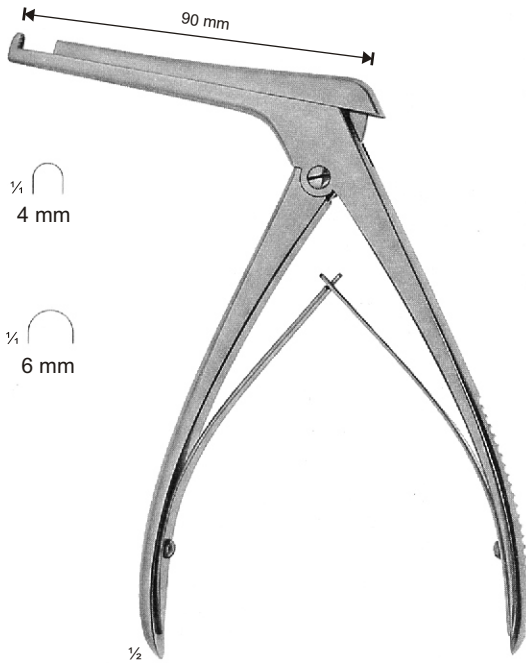

KERRISON
 39-450-03
 39-450-06
 20 cm, 8"

Upwards cutting 90°
 Nach oben schneidend 90°
 Cortante hacia arriba 90°
 Coupant vers le haut 90°
 Taglio a 90° verso l'alto

	Width of bite Bissbreite Anchura de la boca Largeur des mors Larghezza del morso	Length of shaft Schaftlänge Longitud del vástago Longueur de la tige Lunghezza dell'asta
39-450-03	3 mm	90 mm
39-450-04	4 mm	90 mm
39-450-05	5 mm	90 mm
39-450-06	6 mm	90 mm

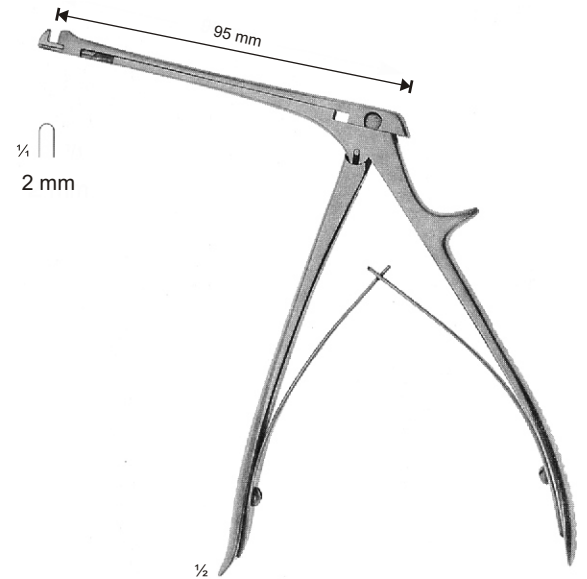

BEYER
 39-460-02

Upwards cutting 90°
 Nach oben schneidend 90°
 Cortante hacia arriba 90°
 Coupant vers le haut 90°
 Taglio a 90° verso l'alto

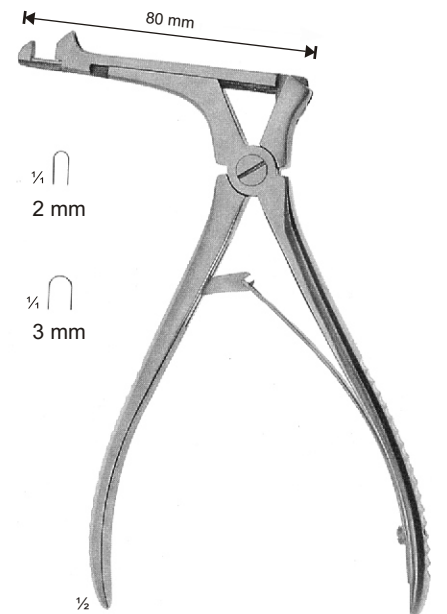

CITELLI
 39-470-02
 39-470-03

Upwards cutting 90°
 Nach oben schneidend 90°
 Cortante hacia arriba 90°
 Coupant vers le haut 90°
 Taglio a 90° verso l'alto

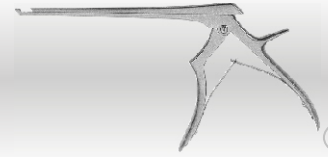

 39-500-03
 3,5 mm

 39-500-04
 4,6 mm

upwards cutting 90°
 nach oben schneidend 90°
 cortante hacia arriba 90°
 coupant vers le haut 90°
 taglio a 90° verso l'alto

 39-502-03
 3,5 mm



 39-502-04
 4,6 mm

downwards cutting 90°
 nach unten schneidend 90°
 cortante hacia abajo 90°
 coupant vers le bas 90°
 taglio a 90° verso il basso

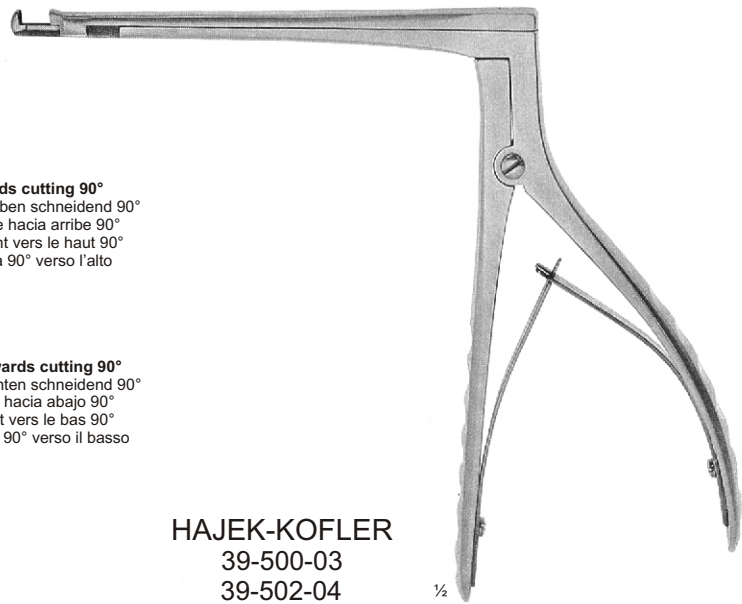
HAJEK-KOFLER
 39-500-03
 39-502-04

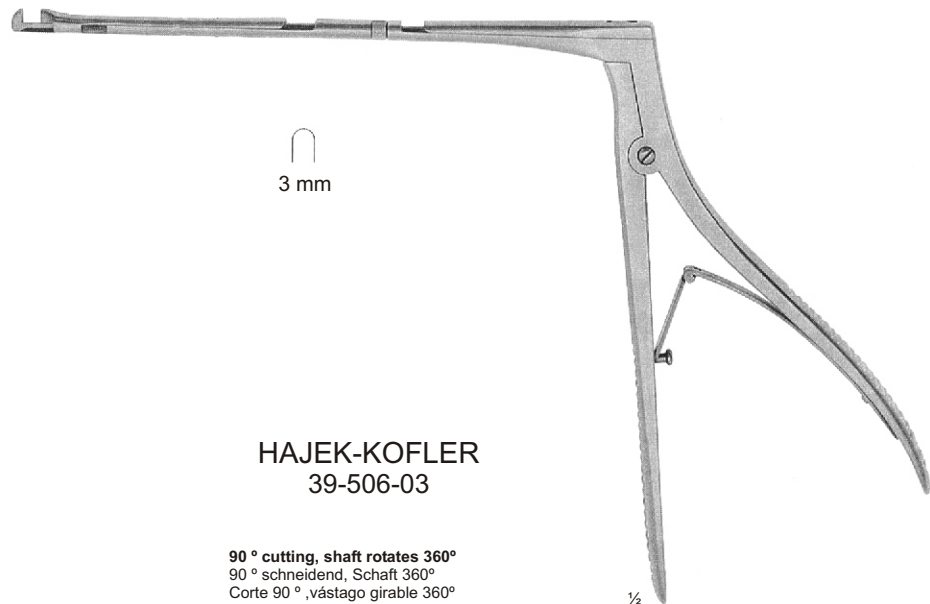

½





 3 mm

HAJEK-KOFLER
 39-506-03

90 ° cutting, shaft rotates 360°
 90 ° schneidend, Schaft 360°
 Corte 90 °, vástago girable 360°
 Coupant à 90 °, tige tournant 360°
 Taglio a 90°, albero rotante di 360°

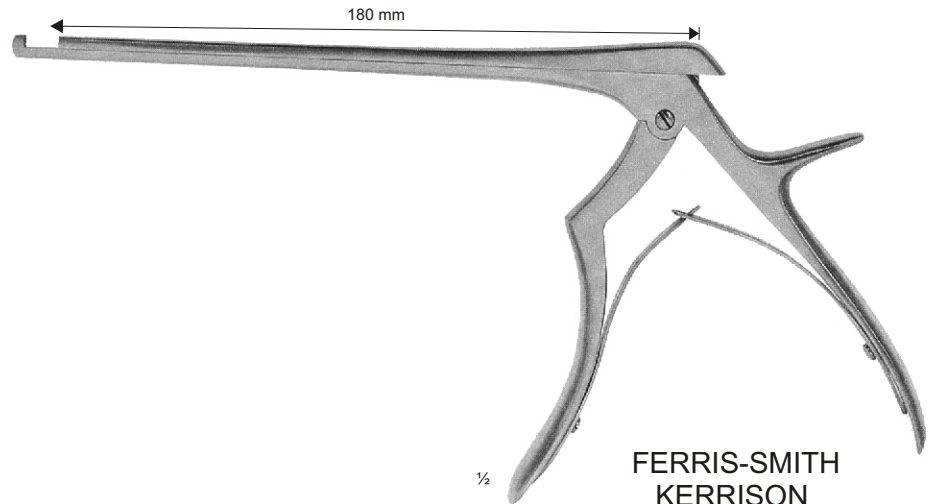
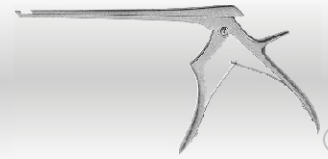
½



**FERRIS-SMITH
 KERRISON**
 39-480-01
 39-486-06

Length of shaft 180 mm
 Schaftlänge 180 mm
 Longitud del vástago 180 mm
 Longueur de la tige 180 mm
 Lunghezza dell'asta 180 mm

Length of shaft 180 mm
 Schaftlänge 180 mm
 Longitud del vástago 180 mm
 Longueur de la tige 180 mm
 Lunghezza dell'asta 180 mm

Length of shaft 200 mm
 Schaftlänge 200 mm
 Longitud del vástago 200 mm
 Longueur de la tige 200 mm
 Lunghezza dell'asta 200 mm

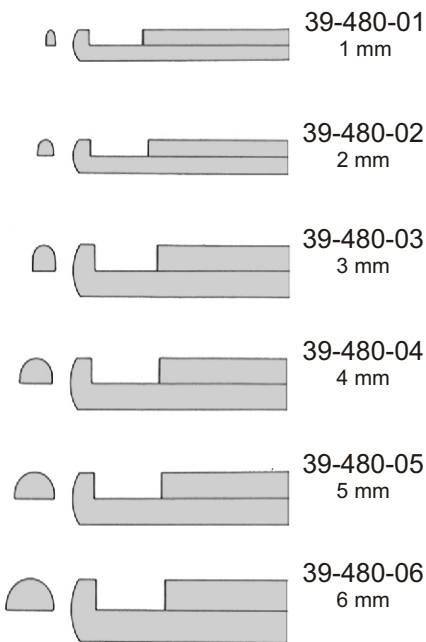

39-480-01
 39-480-06

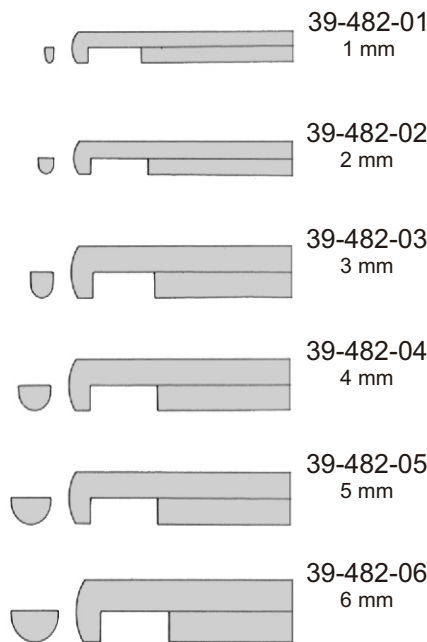

39-482-01
 39-482-06

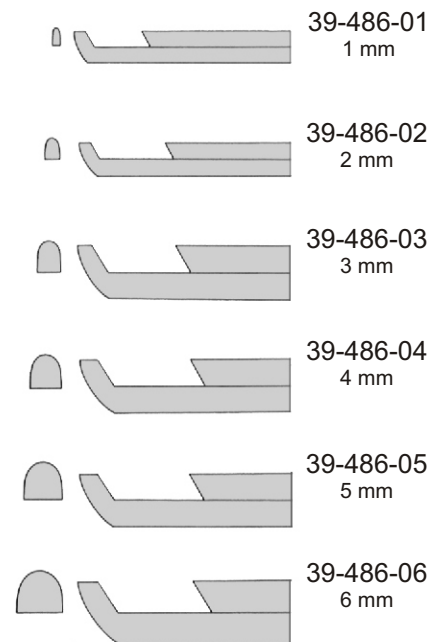

39-486-01
 39-486-06

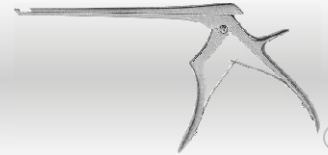

Length of shaft 200 mm
 Schaftlänge 200 mm
 Longitud del vástago 200 mm
 Longueur de la tige 200 mm
 Lunghezza dell'asta 200 mm

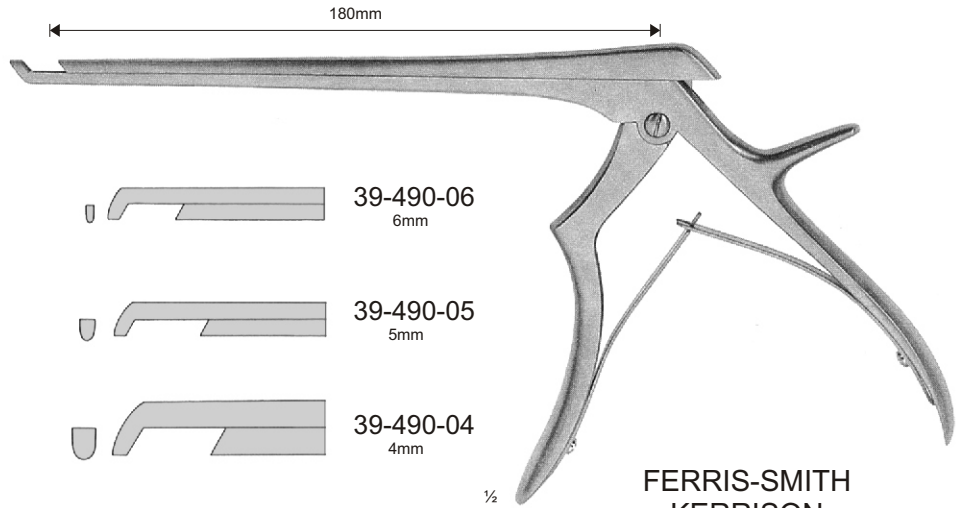

- 39-488-01
1mm
- 39-488-02
2mm
- 39-488-03
3mm
- 39-488-04
4mm
- 39-488-05
5mm
- 39-488-06
6mm

- 39-490-06
6mm
- 39-490-05
5mm
- 39-490-04
4mm
- 39-490-03
3mm
- 39-490-02
2mm
- 39-490-01
1mm

**FERRIS-SMITH
KERRISON**

39-488-01
39-488-06

upwards cutting 90°
 nach oben schneidend 90°
 cotante hacia arriba 90°
 coupant vers le haut 90°
 taglio a 90° verso l'alto

39-490-01
39-490-06

downwards cutting 90°
 nach unten schneidend 90°
 cotante hacia abajo 90°
 coupant vers le bas 90°
 taglio a 90° verso il basso

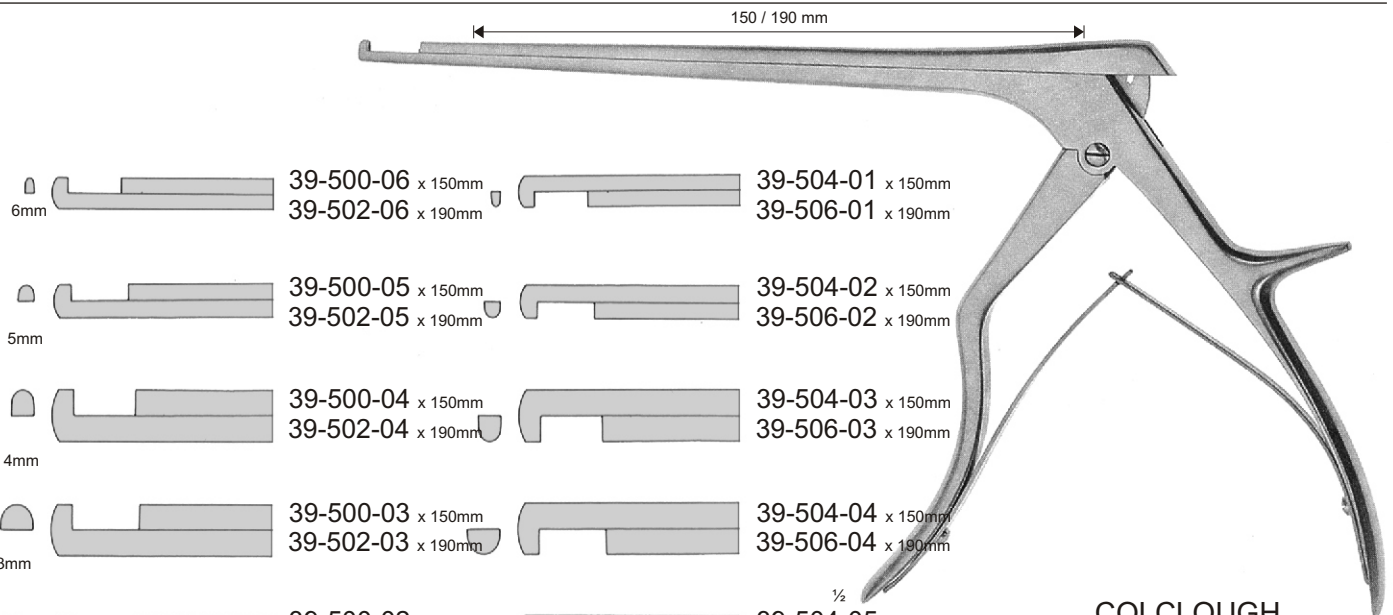

- 39-500-06 x 150mm
39-502-06 x 190mm
- 39-500-05 x 150mm
39-502-05 x 190mm
- 39-500-04 x 150mm
39-502-04 x 190mm
- 39-500-03 x 150mm
39-502-03 x 190mm
- 39-500-02 x 150mm
39-502-02 x 190mm
- 39-500-01 x 150mm
39-502-01 x 190mm

- 39-504-01 x 150mm
39-506-01 x 190mm
- 39-504-02 x 150mm
39-506-02 x 190mm
- 39-504-03 x 150mm
39-506-03 x 190mm
- 39-504-04 x 150mm
39-506-04 x 190mm
- 39-504-05 x 150mm
39-506-05 x 190mm
- 39-504-06 x 150mm
39-506-06 x 190mm

COLCLOUGH

39-500-01
39-504-06

Length of shaft 180 mm
 Schaftlänge 180 mm
 Longitud del vástago 180 mm
 Longueur de la tige 180 mm
 Lunghezza dell'asta 180mm

39-502-01
39-506-06

Length of shaft 190 mm
 Schaftlänge 190 mm
 Longitud del vástago 190 mm
 Longueur de la tige 190 mm
 Lunghezza dell'asta 190mm

39-500-01
39-504-06

39-502-01
39-506-06

Lamicectomy Punches

Laminektomie-Stanzen
 Pinzas cortantes para laminectomia
 Pincas emporte-pièce à laminectomie
 Pinze per laminectomia

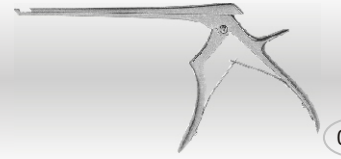

Length of shaft 200 mm
 Schaftlänge 200 mm
 Longitud del vástago 200 mm
 Longueur de la tige 200 mm
 Lunghezza dell'asta 200 mm

- | | | |
|-----|--|--|
| 1mm | | 39-508-01 x 180mm
39-510-01 x 200mm |
| 2mm | | 39-508-02 x 180mm
39-510-02 x 200mm |
| 3mm | | 39-508-03 x 180mm
39-510-03 x 200mm |
| 4mm | | 39-508-04 x 180mm
39-510-04 x 200mm |
| 5mm | | 39-508-05 x 180mm
39-510-05 x 200mm |
| 6mm | | 39-508-06 x 180mm
39-510-06 x 200mm |

150 / 190 mm

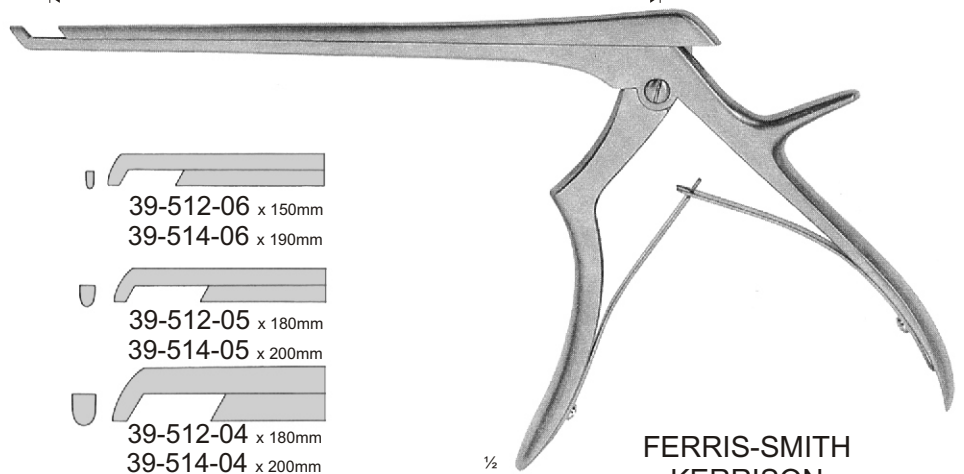

FERRIS-SMITH KERRISON

- | | |
|--|--|
| | 39-512-06 x 150mm
39-514-06 x 190mm |
| | 39-512-05 x 180mm
39-514-05 x 200mm |
| | 39-512-04 x 180mm
39-514-04 x 200mm |
| | 39-512-03 x 180mm
39-514-03 x 200mm |
| | 39-512-02 x 180mm
39-514-02 x 200mm |
| | 39-512-01 x 180mm
39-514-01 x 200mm |

39-488-01
39-488-06

upwards cutting 90°
 nach oben schneidend 90°
 cotante hacia arriba 90°
 coupant vers le haut 90°
 taglio a 90° verso l'alto

39-490-01
39-490-06

downwards cutting 90°
 nach unten schneidend 90°
 cotante hacia abajo 90°
 coupant vers le bas 90°
 taglio a 90° verso il basso

180mm

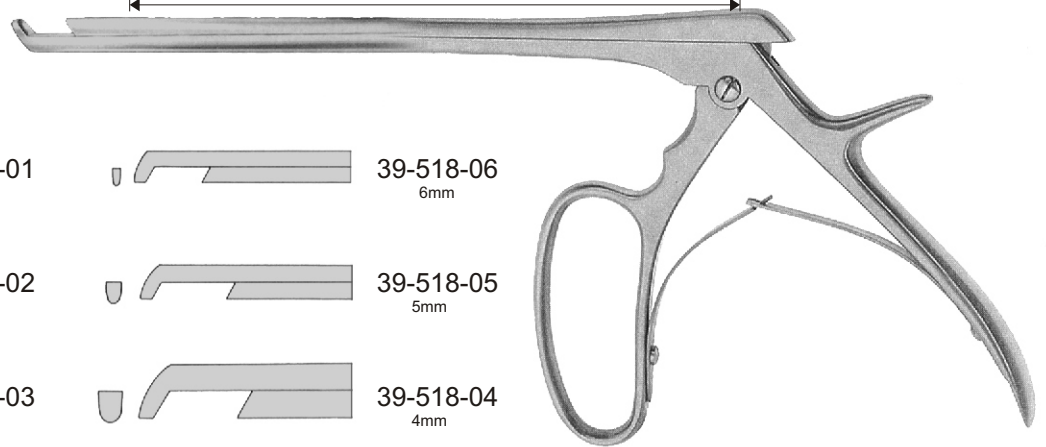

- | | | | |
|--|------------------|--|------------------|
| | 39-516-01
1mm | | 39-518-06
6mm |
| | 39-516-02
2mm | | 39-518-05
5mm |
| | 39-516-03
3mm | | 39-518-04
4mm |
| | 39-516-04
4mm | | 39-518-03
3mm |
| | 39-516-05
5mm | | 39-518-02
2mm |
| | 39-516-06
6mm | | 39-518-01
1mm |

COLCLOUGH



Laminectomy Rongeurs

Laminektomie-Zangen

Pinzas cortantes para laminectomía

Pinces emporte-pièces à laminectomie

Pinze per laminectomia



039

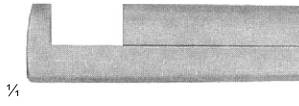

1/4

39-530-03
3 mm x 5

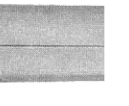

39-530-05
5 mm x 5

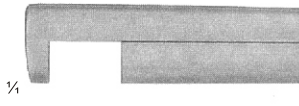

1/4

39-532-03
3 mm x 5

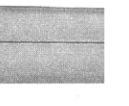

39-532-05
5 mm x 5

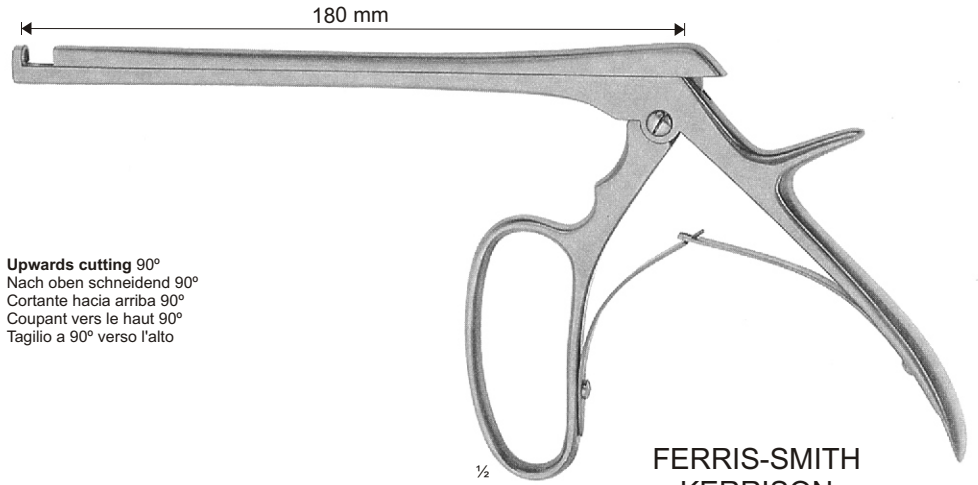

Upwards cutting 90°
Nach oben schneidend 90°
Cortante hacia arriba 90°
Coupant vers le haut 90°
Taglio a 90° verso l'alto

**FERRIS-SMITH
KERRISON**
39-360-03
39-364-05

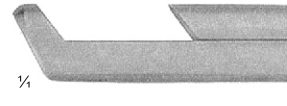

1/4

downwards cutting 90°
nach unten schneidend 90°
cotante hacia abajo 90°
coupant vers le bas 90°
taglio a 90° verso il basso

39-534-03
3 mm x 3



39-534-03
5 mm x 5



Upwards cutting 130°
Nach oben schneidend 130°
Cortante hacia arriba 130°
Coupant vers le haut 130°
Taglio a 130° verso l'alto

Straight
Gerade
Recta
Droits
Retta

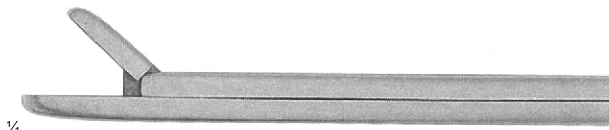
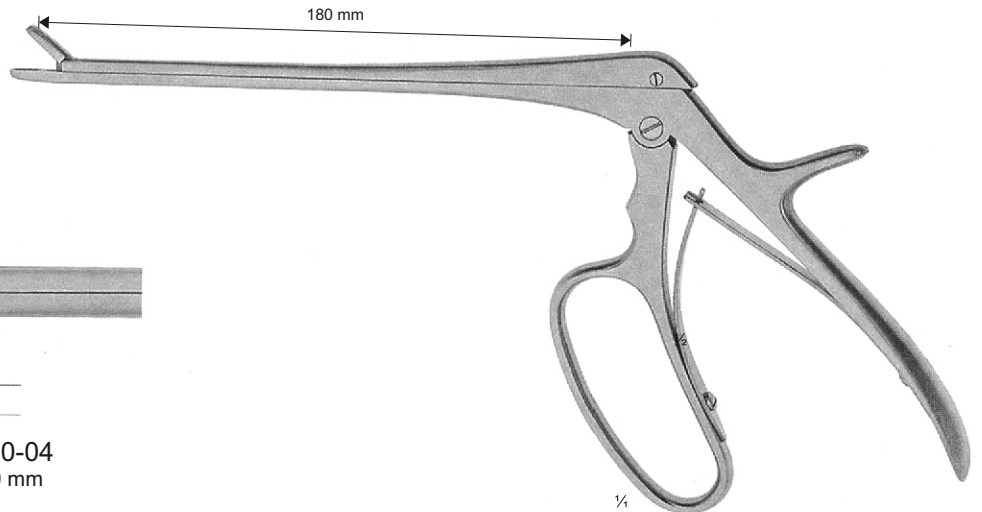

1/4

39-540-02
2 x 10 mm

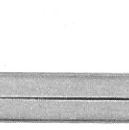

39-540-03
3 x 10 mm

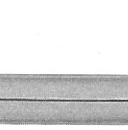

39-540-04
4 x 10 mm

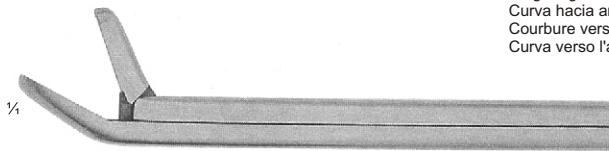

1/4

39-542-02
2 x 10 mm



39-542-03
3 x 10 mm

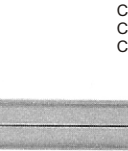

39-542-04
4 x 10 mm



Curved on flat
Aufgebogen
Curva hacia arriba
Courbure vers le haut
Curva verso l'alto

FERRIS-SMITH-CUSHING
39-540-02
39-544-04

Curved down
Abwärts gebogen
Curva hacia abajo
Courbure vers le bas
Curva verso il basso

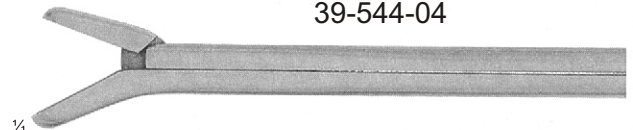

1/4

39-544-02
2 x 10 mm



39-544-03
3 x 10 mm

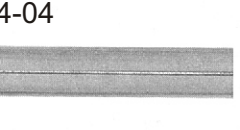

39-544-04
4 x 10 mm



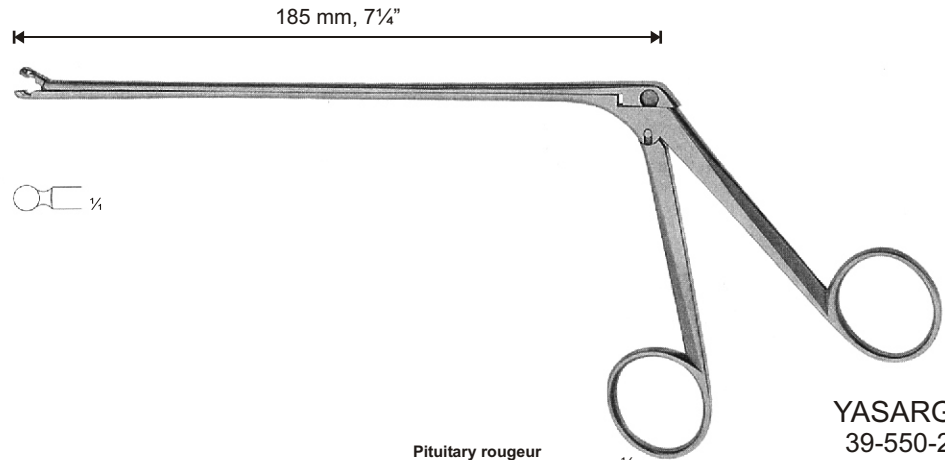
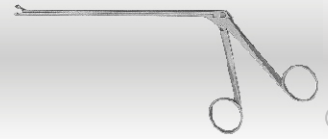

Pituitary rongeur
 Hypophysenzange
 Pinza para hipófisis
 Pince pour l'hypophyse
 Pinza ipofisaria

YASARGIL
 39-550-25
 25,5 cm, 10 $\frac{1}{4}$ "
 3,5 mm

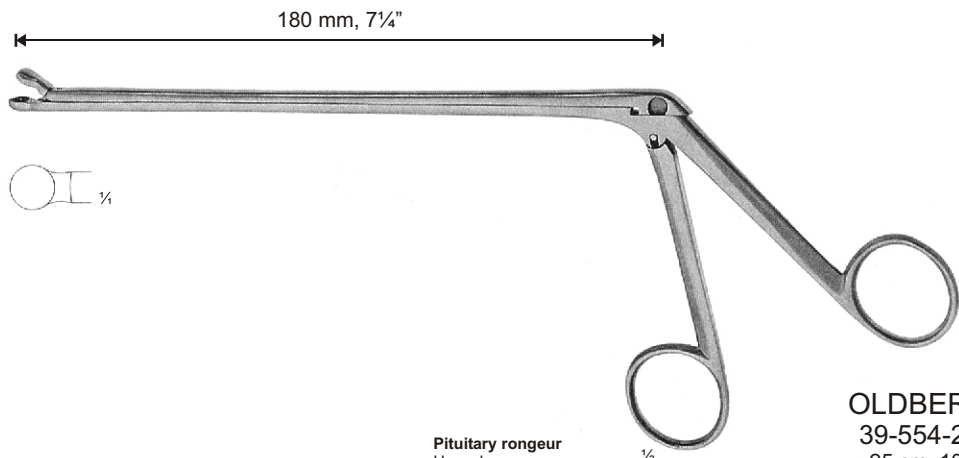

Pituitary rongeur
 Hypophysenzange
 Pinza para hipófisis
 Pince pour l'hypophyse
 Pinza ipofisaria

OLDBERG
 39-554-25
 25 cm, 10"
 6 mm

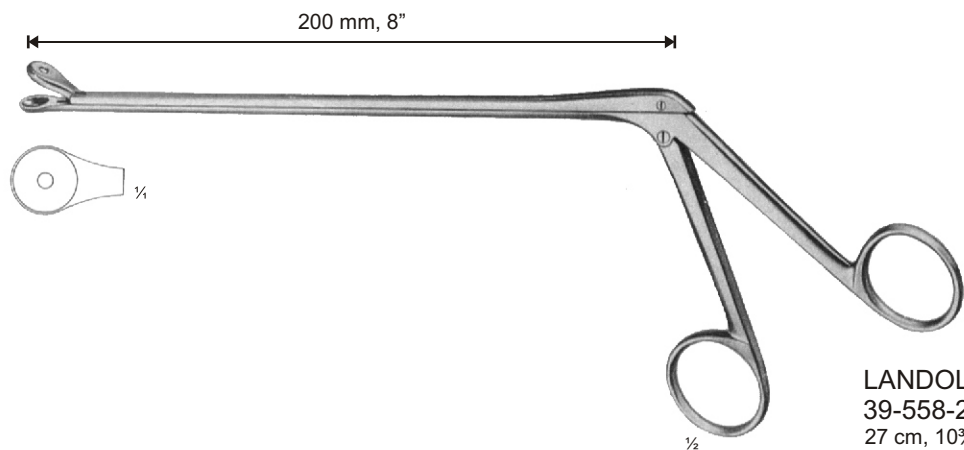

LANDOLT
 39-558-27
 27 cm, 10 $\frac{3}{4}$ "

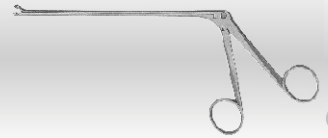

120 mm

¼ 39-560-30
30 mm

¼ 39-560-36
36 mm

¼ 39-560-42
42 mm

¼ 39-560-48
48 mm

¼ 39-560-58
58 mm

WEIL-BLAKESLEY
 39-560-30
 39-560-58
 19 cm, 7½"
 Straight
 Gerade
 Recta
 Droits
 Retta

110 mm

¼ 39-562-30
30 mm

¼ 39-562-36
36 mm

¼ 39-562-42
42 mm

¼ 39-562-48
48 mm

¼ 39-562-58
58 mm

WEIL-BLAKESLEY
 39-562-30
 39-562-58
 19 cm, 7½"
 Curved on flat
 Aufgebogen
 Curva hacia arriba
 Courbure vers le haut
 Curva verso l'alto

120 mm

3 x 10 mm

TAKAHASHI
 39-566-03
 3 X 10 mm
 19 cm, 7½"

Straight
 Gerade
 Recta
 Droits
 Retta

115 mm

3 x 10 mm

TAKAHASHI
 39-568-03
 3 X 10 mm
 18 cm, 7"

Curved on flat
 Aufgebogen
 Curva hacia arriba
 Courbure vers le haut
 Curva verso l'alto

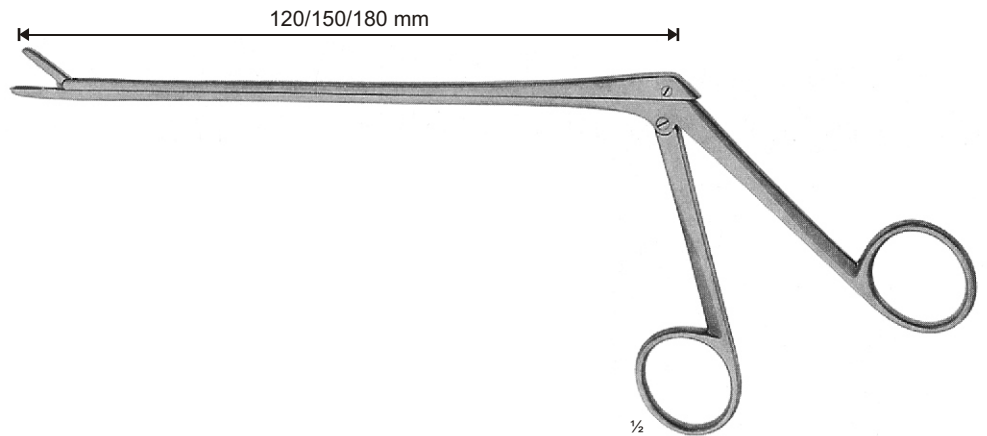
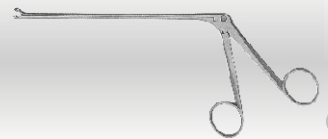

CUSHING

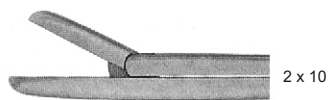

- 39-570-01 12 cm
- 39-570-02 15 cm
- 39-570-03 18 cm

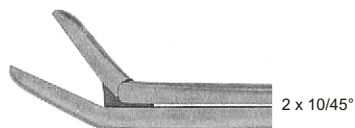

- 39-571-01 12 cm
- 39-571-02 15 cm
- 39-571-03 18 cm



- 39-572-01 12 cm
- 39-572-02 15 cm
- 39-572-03 18 cm

LOVE-GRVENWALD

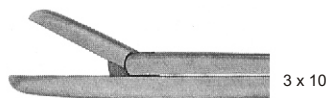

- 39-574-01 12 cm
- 39-574-02 15 cm
- 39-574-03 18 cm

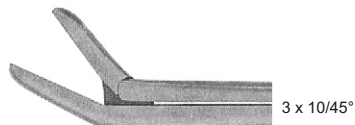

- 39-575-01 12 cm
- 39-575-02 15 cm
- 39-575-03 18 cm

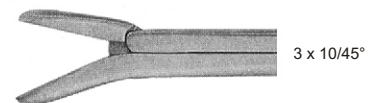

- 39-576-01 12 cm
- 39-576-02 15 cm
- 39-576-03 18 cm

SPURLING

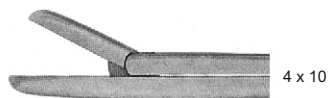

- 39-578-01 12 cm
- 39-578-02 15 cm
- 39-578-03 18 cm

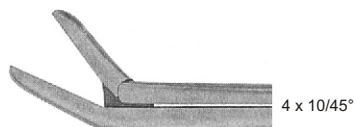

- 39-579-01 12 cm
- 39-579-02 15 cm
- 39-579-03 18 cm

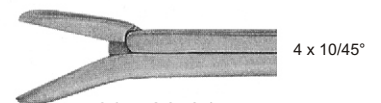

- 39-580-01 12 cm
- 39-580-02 15 cm
- 39-580-03 18 cm

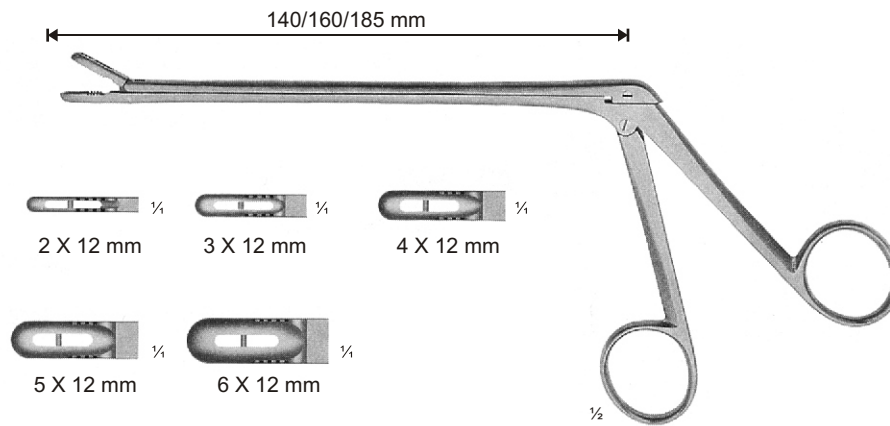
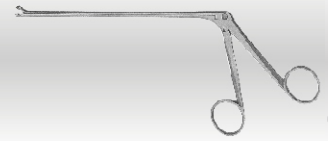

CASPAR
 39-600-02
 39-604-06

Streight
 Gerade
 Recta
 Droits
 Retta

	Width of bite Bissbreite Anchura de la boca Largeur des mors Larghezza del morso	Length of shaft Schaftlänge Longitud del vástago Longueur de la tige Lunghezza dell'asta
39-600-02	2 x 12 mm	140 mm
39-600-03	3 x 12 mm	140 mm
39-600-04	4x 14 mm	140 mm
39-600-05	5x 14 mm	140 mm
39-600-06	6x 16 mm	140 mm
39-602-02	2 x 12 mm	160 mm
39-602-03	3 x 12 mm	160 mm
39-602-04	4 x 14 mm	160 mm
39-602-05	5 x 14 mm	160 mm
39-602-06	6 x 16 mm	160 mm
39-604-02	2 x 12 mm	185 mm
39-604-03	3 x 12 mm	185 mm
39-604-04	4 x 14 mm	185 mm
39-604-05	5 x 14 mm	185 mm
39-604-06	6 x 16 mm	185 mm

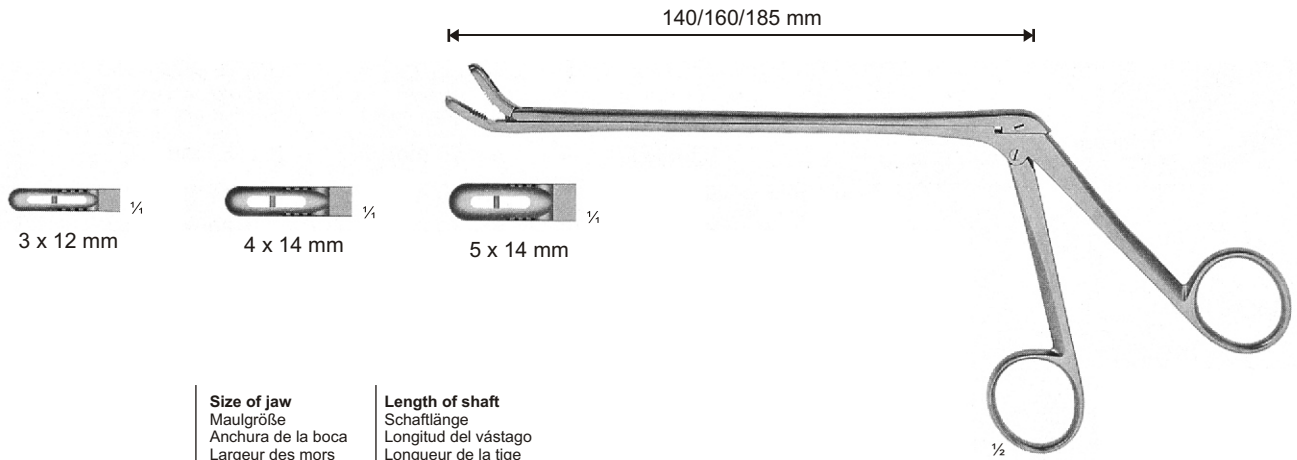
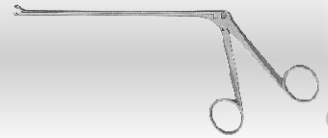

	Size of jaw Maulgröße Anchura de la boca Largeur des mors Larghezza del morso	Length of shaft Schaftlänge Longitud del vástago Longueur de la tige Lunghezza dell'asta
39-610-03	3 x 12 mm	140 mm
39-610-04	4 x 14 mm	140 mm
39-610-05	5 x 14 mm	140 mm
39-612-03	3 x 12 mm	160 mm
39-612-04	4 x 14 mm	160 mm
39-612-05	5 x 14 mm	160 mm
39-614-03	3 x 12 mm	185 mm
39-614-04	4 x 14 mm	185 mm
39-614-05	5 x 14 mm	185 mm

CASPAR
 39-610-03
 - 39-614-05

Curved on flat
 Aufgebogen
 Curva hacia arriba
 Courbure vers le haut
 Curva verso l'alto

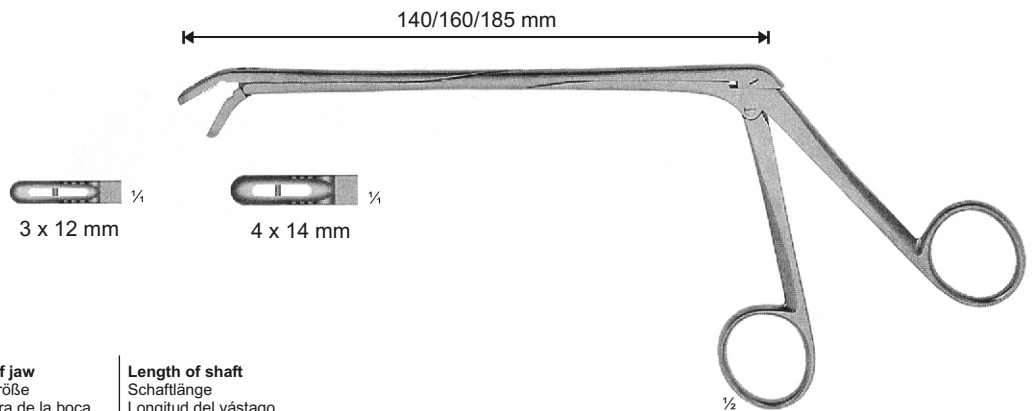

	Size of jaw Maulgröße Anchura de la boca Largeur des mors Larghezza del morso	Length of shaft Schaftlänge Longitud del vástago Longueur de la tige Lunghezza dell'asta
39-620-03	3 x 12 mm	140 mm
39-620-04	4 x 14 mm	140 mm
39-622-03	3 x 12 mm	160 mm
39-622-04	4 x 14 mm	160 mm
39-624-03	3 x 12 mm	185 mm
39-624-04	4 x 14 mm	185 mm

CASPAR
 39-620-03
 39-624-04

Curved down
 Abwärts gebogen
 Curva hacia abajo
 Courbure vers le bas
 Curva verso il basso