

041



Tracheotomy
Tracheotomie
Traqueotomia
Trachéotomie
Tracheotomia



1/2
ROSE
41-100-13
13 cm, 5"



1/2
JACKSON
41-102-17
17cm, 6 3/4"

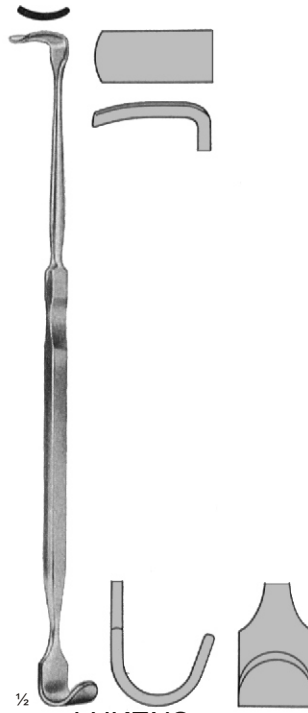

1/2
LUKENS
41-104-17
17cm, 6 3/4"



1/2
LUER
41-110-11
11cm, 4 1/2"

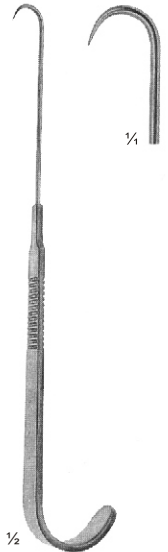

1/2
NEWS
41-112-14
14 cm, 5 1/2"



JACKSON
41-114-15
15 cm, 6"

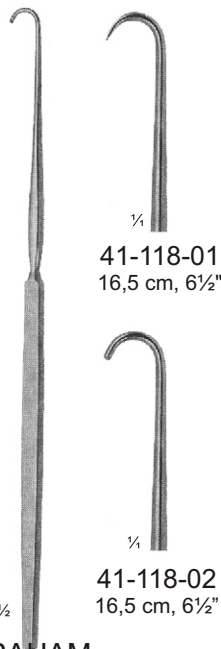

1/2
GRAHAM
41-118-01
41-118-02

1/4
41-118-01
16,5 cm, 6 1/2"

1/4
41-118-02
16,5 cm, 6 1/2"

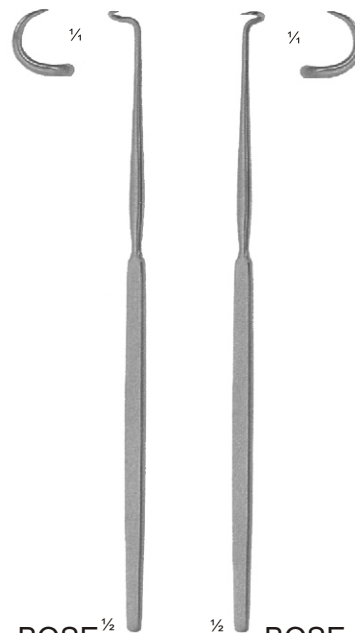

1/2
BOSE
41-120-16
16 cm, 6 1/4"

1/2
BOSE
41-122-16
16 cm, 6 1/4"

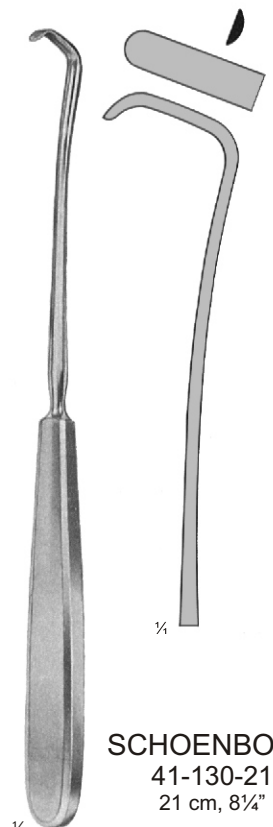

1/2
SCHOENBORN
41-130-21
21 cm, 8 1/4"

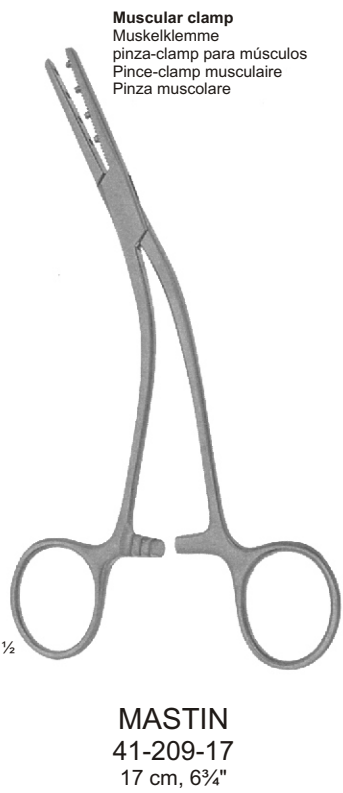
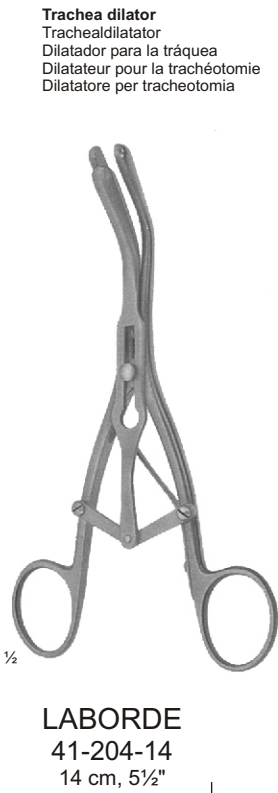

Director-enucleator
 Kropfsonde
 Sonda para bocio
 Spatule à goitre
 Sonda per gozzo

KOCHER
15-711-15
15 cm, 6"



Director-enucleator
 Kropfsonde
 Sonda para bocio
 Spatule à goitre
 Sonda per gozzo

KOCHER
15-713-18
18 cm, 7"

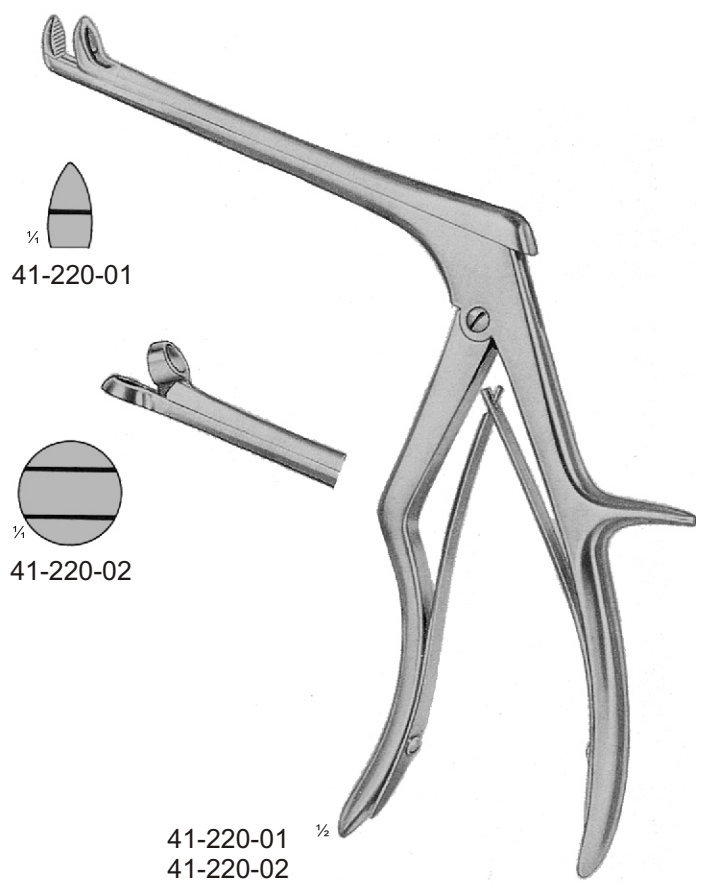

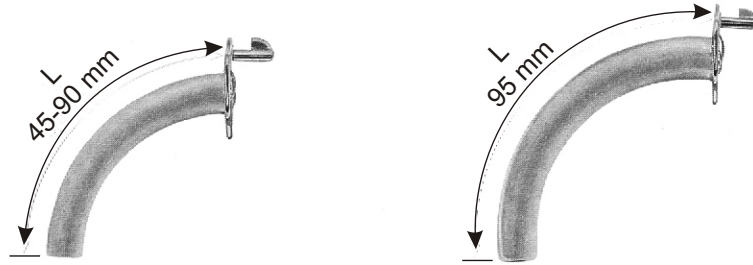

Fig.	0	1	2	3	4	5	6	7	8	9
Ø mm	④	⑤	⑥	⑦	⑧	⑨	⑩	⑪	⑫	⑬

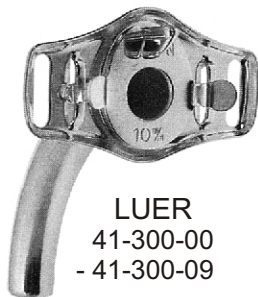

Fig.	Ø mm	L mm	German silver Neusilber Plata meneses Argent blanc Argento bianco	Silver Silber Plata Argent Argento	Fig.	Ø mm	L mm	German silver Neusilber Plata meneses Argent blanc Argento bianco	Silver Silber Plata Argent Argento
0	4	45	41-300-00	41-102-00	5	9	70	41-300-06	41-102-05
1	5	50	41-300-01	41-102-01	6	10	75	41-300-07	41-102-06
2	6	55	41-300-02	41-102-02	7	11	80	41-300-08	41-102-07
3	7	60	41-300-03	41-102-03	8	12	85	41-300-09	41-102-08
4	8	65	41-300-04	41-102-04	9	13	90		41-102-09

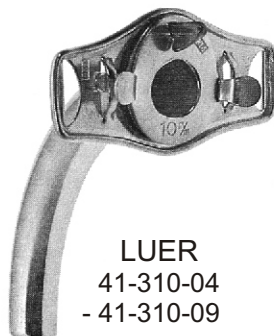

Fig.	Ø mm	L mm	German silver Neusilber Plata meneses Argent blanc Argento bianco	Silver Silber Plata Argent Argento	Fig.	Ø mm	L mm	German silver Neusilber Plata meneses Argent blanc Argento bianco	Silver Silber Plata Argent Argento
4	8	95	41-310-04	41-112-04	7	11	95	41-310-07	41-112-07
5	9	95	41-310-05	41-112-05	8	12	95	41-310-08	41-112-08
6	10	95	41-310-06	41-112-06	9	13	95	41-310-09	41-112-09

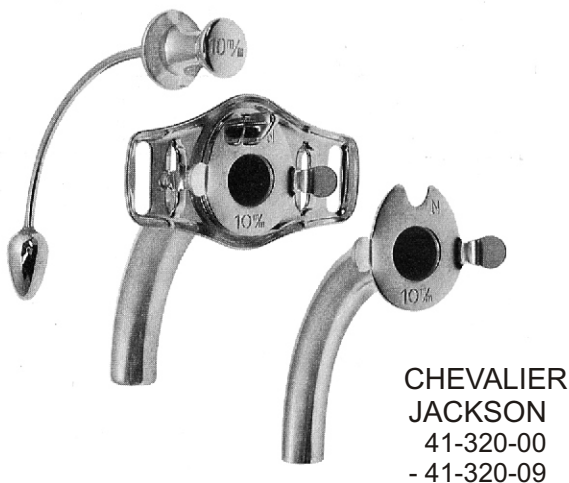

Fig.	Ø mm	L mm	German silver Neusilber Plata meneses Argent blanc Argento bianco	Silver Silber Plata Argent Argento	Stainless steel 18/8 Rostfreier stahl 18/8 Acero inoxidable 18/8 Acier inox 18/8 Acciaio inox 18/8
0	4	45	41-320-00	41-122-00	41-124-00
1	5	50	41-320-01	41-122-01	41-124-01
2	6	55	41-320-02	41-122-02	41-124-02
3	7	60	41-320-03	41-122-03	41-124-03
4	8	65	41-320-04	41-122-04	41-124-04
5	9	70	41-320-05	41-122-05	41-124-05
6	10	75	41-320-06	41-122-06	41-124-06
7	11	80	41-320-07	41-122-07	41-124-07
8	12	85	41-320-08	41-122-08	41-124-08
9	13	90	41-320-09	41-122-09	41-124-09



Regular radius
 Normalradius
 Radio normal
 Rayon normal
 Raggio normale

Fig.	ø mm	L mm	German silver Neusilber Plata menseses Argent blanc Argento bianco
4	8	65	41-330-04
5	9	70	41-330-05
6	10	75	41-330-06
7	11	80	41-330-07
8	12	85	41-330-08
9	13	90	41-330-09

Valve speaking tubes, with detachable round valve
 Ventil-Sprechkanülen mit rundem aufsteckventil
 Cánulas traqueales con válvula para hablar, redonda
 Canules parlantes avec soupape ronde amovible
 Cannule parlante con valvola rotonda mobile

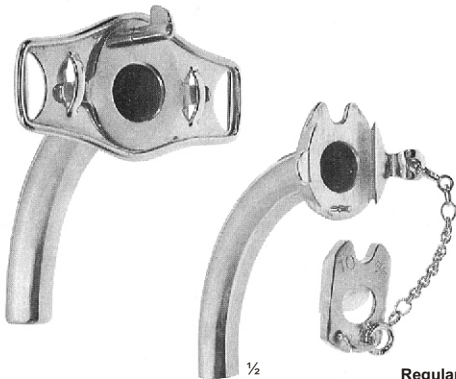

Regular radius
 Normalradius
 Radio normal
 Rayon normal
 Raggio normale

Fig.	ø mm	L mm	German silver Neusilber Plata menseses Argent blanc Argento bianco	Silver Silber Plata Argent Argento
4	8	65	41-140-04	41-340-04
5	9	70	41-140-05	41-340-05
6	10	75	41-140-06	41-340-06
7	11	80	41-140-07	41-340-07
8	12	85	41-140-08	41-340-08
9	13	90	41-140-09	41-340-09

Valve speaking tubes, inner tube with sliding valve

Ventil-Sprechkanülen, Innenrohr mit schiebeventil

Cánulas traqueales con válvula para hablar, cánula interior con válvula de corredera

Canules parlantes, tube intérieur avec soupape à coulisse

Canule parlanti, tubo interno con valvola scorrevole

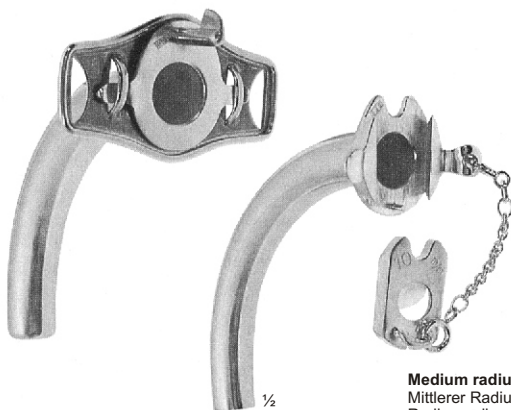

Medium radius
 Mittlerer Radius
 Radio medio
 Rayon moyen
 Raggio medio

Fig.	ø mm	L mm	German silver Neusilber Plata menseses Argent blanc Argento bianco
4	8	95	41-350-04
5	9	95	41-350-05
6	10	95	41-350-06
7	11	95	41-350-07
8	12	95	41-350-08
9	13	95	41-350-09

Valve speaking tubes, inner tube with sliding valve

Ventil-Sprechkanülen, Innenrohr mit schiebeventil

Cánulas traqueales con válvula para hablar, cánula interior con válvula de corredera

Canules parlantes, tube intérieur avec soupape à coulisse

Canule parlanti, tubo interno con valvola scorrevole

ø 12 mm



41-360-26
 26 cm 10¼"

Cleaning brush for trachea tubes

Reinigungsbürste für trachealkanülen

Cepillo de limpieza para cánulas traqueales

Brosse à nettoyer les canules trachéales

Spazzolino per pulire per cannule tracheali

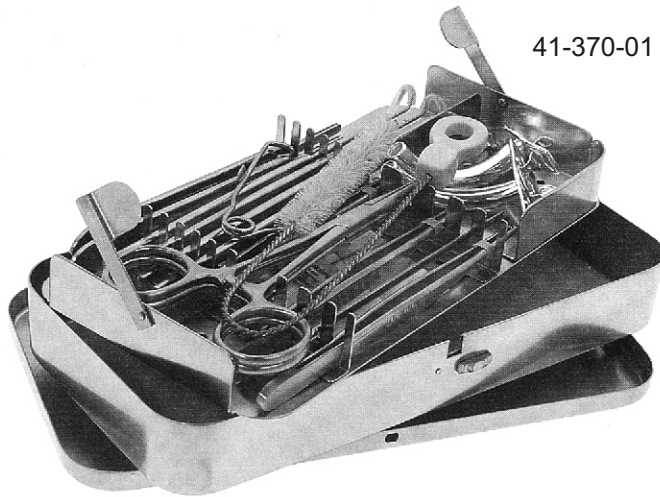
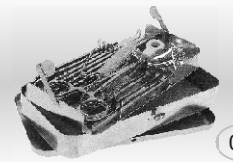

41-370-01

41-370-01

205 X 105X 30

41-370-00

Tracheotomy set, complete, consisting of:

- 41-370-01 1 Rack
- 41-370-02 1 Metal case
- 05-370-04 2 Handles No. 4
- 05-150-20 1 Blade fig. 20
- 05-150-23 1 Blade fig. 23
- 11-316-13 2 PEAN Artery forceps, 13 cm, 5"
- 09-260-13 1 Dissecting forceps, 13 cm, 5"
- 09-461-13 2 Tissue forceps, 13 cm, 5" 1x2 teeth
- 19-132-13 1 Grooved director, 13 cm, 5"
- 17-216-01 2 Trachea retractors, blunt, 16,5 cm, 6½"
- 17-675-07 1 FINSEN retractor, blunt, 7 cm, 2¾"
- 41-120-16 1 BOSE trachea retractor, sharp, left, 16 cm, 6¼"
- 41-122-16 1 BOSE trachea retractor, sharp, right, 16 cm, 6¼"
- 41-300-03 1 LUER trachea tube, fig. 3, ø 7 mm
- 41-300-04 1 LUER trachea tube, fig. 4, ø 8 mm
- 41-360-30 1 Cleaning brush, 30 cm, 12"

41-380-03

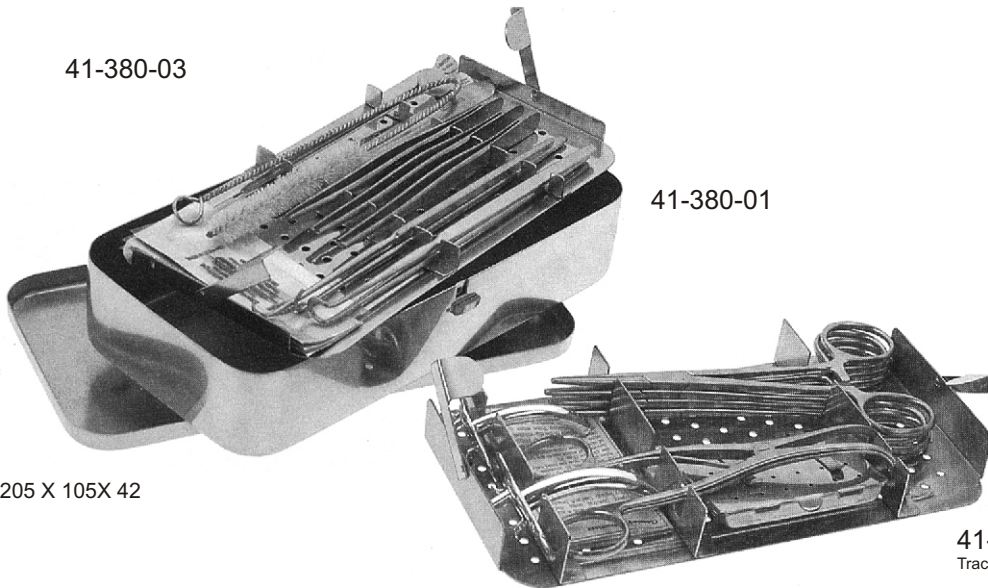

41-380-01

41-380-02

205 X 105X 42

41-380-00

Tracheotomy set, complete, consisting of:

- 41-380-01 1 Rack
- 41-380-02 1 Rack
- 41-380-03 1 Metal case
- 05-162-04 1 Handle No. 4
- 05-150-20 1 Blade fig. 20
- 05-150-22 1 Blade fig. 22
- 05-150-23 2 Blades fig. 23
- 11-184-14 4 CRILE Artery forceps, straight, 14 cm, 5½"
- 09-260-13 1 Dissecting forceps, 13 cm, 5"
- 09-461-13 2 Tissue forceps, 13 cm, 5¼" 1x2 teeth
- 19-132-13 1 Grooved director, 13 cm, 5¼"
- 17-216-01 2 Trachea retractors, blunt 16,5 cm, 6½"
- 41-120-16 1 BOSE Trachea retractor, sharp, left, 16,5 cm, 6½"
- 41-122-16 1 BOSE Trachea retractor, sharp, right, 16,5 cm, 6½"
- 41-200-14 1 TROUSSEAU Trachea dilator, 14 cm, 5½"
- 41-300-02 1 LUER Trachea tube, fig. 2, ø 6 mm, German silver
- 41-300-04 1 LUER Trachea tube, fig. 4, ø 8 mm, German silver
- 41-360-30 1 Cleaning brush, 30 cm, 12"