



**Anaesthesia**  
**Narkose**  
**Anestesia**  
**Anesthésie**  
**Anestesia**

**Tongue Holding Forceps**

Zungenzangen  
Pinzas tira-lengua  
Pinces tire-langue  
Pinze tiralingua

**Suction Tubes**

Saugrohre  
Tubos para aspiración  
Canules d'aspiration  
Tubi aspirazione



03-100-01

1 Pair of rubber pads  
1 paar Ersatzgummi  
1 par de gomas de repuesto  
1 paire de mors en caoutchouc  
1 paio di morsi di ricambio

**YOUNG**  
03-100-17  
17 cm, 6 3/4"



**COLLIN**  
03-110-17 17 cm, 6 3/4"  
03-110-19 19 cm, 7 1/2"

 03-114-15  
15 cm, 6"

for infants  
für Kleinkinder  
para niños pequeños  
pour nourissons  
per neonati

 03-114-20  
20 cm, 8"

for children  
für Kinder  
para niños  
pour enfants  
per bambini

 03-114-25  
25 cm, 10"

for adults  
für Erwachsene  
para adultos  
pour adultes  
per adulti

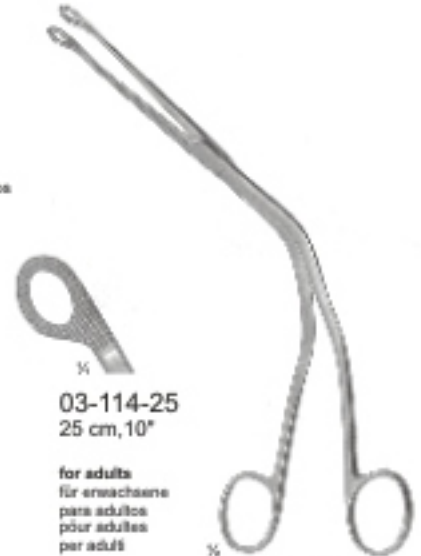

**MAGILL**  
03-114-15  
03-114-25

Ø 10 mm



**POOLE**  
03-120-22  
22 cm, 8 3/4"

Ø 8 mm



**POOLE**  
03-121-22  
22 cm, 8 3/4"

Ø 10 mm



**03-126-01**  
Suction basket only  
Saugkopf allein  
Cabezal para aspiración, suelto  
Embout d'aspiration seul  
Solo cestello aspirazione

**YANKAUER**  
03-126-27  
27 cm, 11"

Ø 9 mm



**03-128-01**  
Suction basket only  
Saugkopf allein  
Cabezal para aspiración, suelto  
Embout d'aspiration seul  
Solo cestello aspirazione

**DE BAKEY**  
03-128-28  
28 cm, 11 1/2"

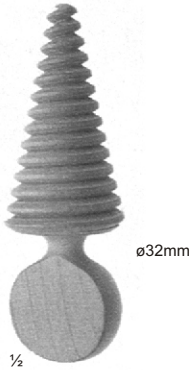

**MAUNDER**  
 03-130-09  
 9,5 cm, 3¾"

**Oral screw of wood**  
 Mundkeil aus Holz  
 Garrote de madera  
 Bâillon en bois  
 Apribocca di legno

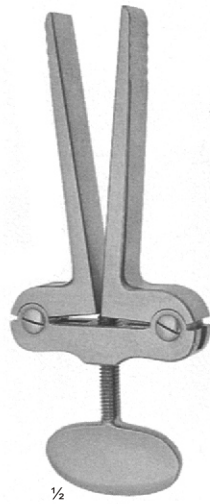

**HEISTER**  
 03-132-13  
 13 cm, 5"

**Mouth gag**  
 Mundsperrer  
 Abre-boca  
 Ouver-bouches  
 Apribocca



**MOLT**  
 03-134-11 11 cm, 4½" (CHILD)  
 03-134-14 14 cm, 5½" (ADULT)

**Mouth gag**  
 Mundsperrer  
 Abre-boca  
 Ouver-bouches  
 Apribocca

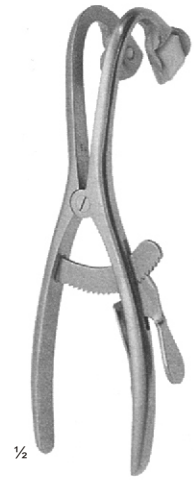

**DENHART**  
 03-136-12  
 12 cm, 4¾"

**Mouth gag**  
 Mundsperrer  
 Abre-boca  
 Ouver-bouches  
 Apribocca

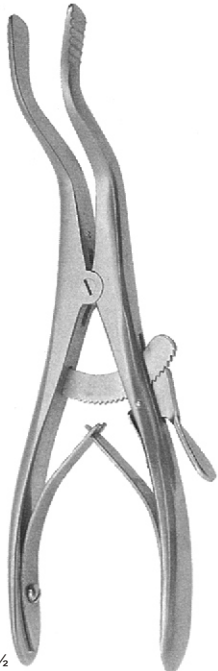

**ROSER-KÖNIG**  
 03-138-16 16 cm, 6¼"  
 03-138-19 19 cm, 7½"

**Mouth gag**  
 Mundsperrer  
 Abre-boca  
 Ouver-bouches  
 Apribocca

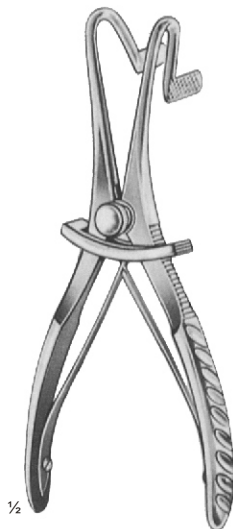

**FERGUSON-ACKLAND**  
 03-140-14  
 14,5 cm, 5¾"

**Mouth gag**  
 Mundsperrer  
 Abre-boca  
 Ouver-bouches  
 Apribocca

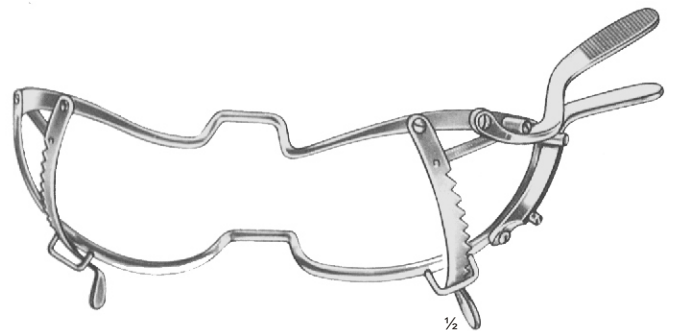

**WHITEHEAD**  
 03-150-11 11 cm, 4¼"  
 03-150-13 13 cm, 5"  
 03-150-15 15 cm, 6"

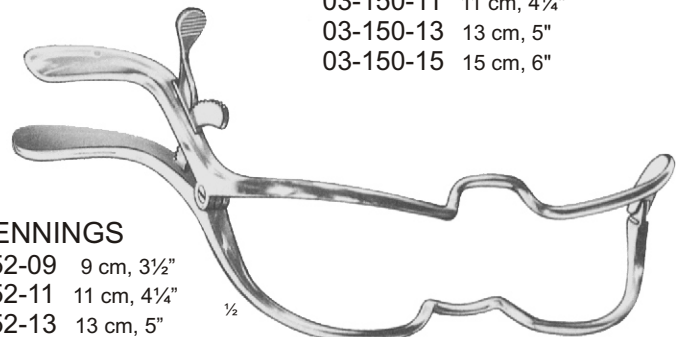

**JENNINGS**  
 03-152-09 9 cm, 3½"  
 03-152-11 11 cm, 4¼"  
 03-152-13 13 cm, 5"  
 03-152-15 15 cm, 6"

**Mouth gag**  
 Mundsperrer  
 Abre-boca  
 Ouver-bouches  
 Apribocca



03-162-01 LEFT  
 03-162-02 RIGHT



**DAVIS BOYLE**  
 03-164-01 LEFT  
 03-164-02 RIGHT

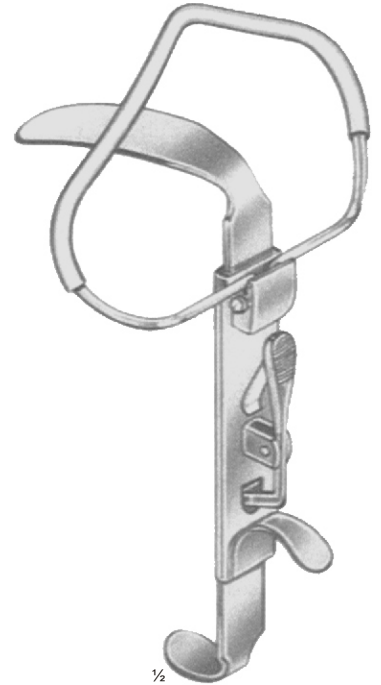

**Mc LVOR**  
 03-166-00

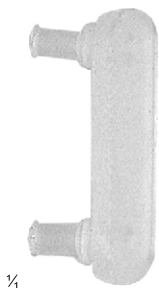

**SILICONE GUARD**  
 03-162-00

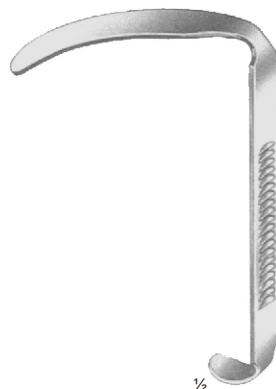

fig.		mm
01	03-168-00	20 x 25
02	03-168-01	20 x 35
03	03-168-1½	22 x 55
04	03-168-02	24 x 68
05	03-168-2½	24 x 72
06	03-168-03	24 x 83
07	03-168-3½	25 x 88
08	03-168-04	26 x 93
09	03-168-05	28 x 108



fig.		mm
01	03-170-01	20 x 35
02	03-170-1½	22 x 54
03	03-170-02	23 x 68
04	03-170-2½	23 x 72
05	03-170-03	24 x 83
06	03-170-3½	25 x 88
07	03-170-04	26 x 93
08	03-170-05	28 x 108



fig.		mm
01	03-172-01	20 x 35
02	03-172-1½	22 x 54
03	03-172-02	23 x 68
04	03-172-2½	23 x 72
05	03-172-03	24 x 83
06	03-172-3½	25 x 88
07	03-172-04	26 x 93
08	03-172-05	28 x 108

**MODELL WÜRZBURG**  
 fig. mm





# Laryngoscopes

Laryngoskope  
Laringoscopios  
Laryngoscopes  
Laringoscopi



03

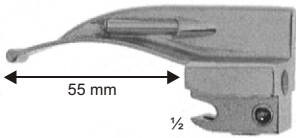

Fig.1  
03-207-01

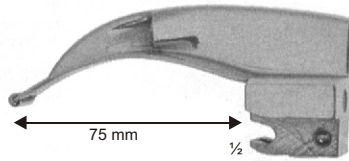

Fig.2  
03-207-02

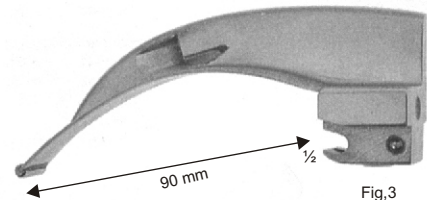

Fig.3  
03-207-03

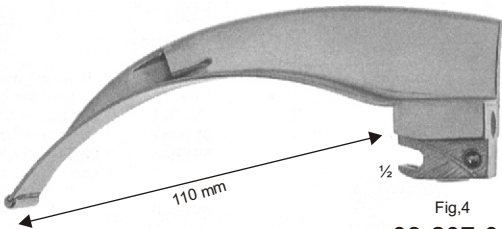

Fig.4  
03-207-04

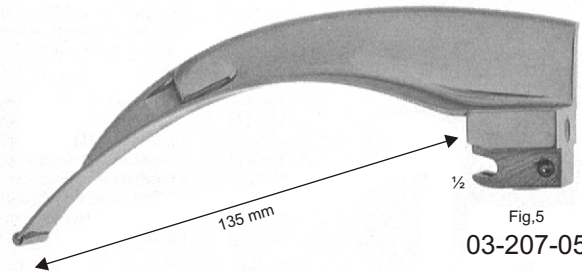
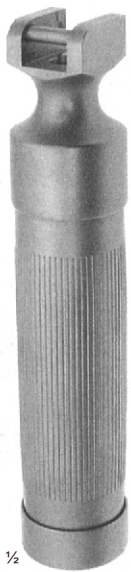

Fig.5  
03-207-05



03-201-01  
14,5 cm, 5<sup>3</sup>/<sub>4</sub>"

Battery handle, ø 30 mm (2 Baby Batteries, 1,5 volt, are required)

Batteriegriff ø 30 mm (2 Baby-Zellen, 1,5 Volt, sind erforderlich)

Mango de pila ø 30 mm (se necesitan 2 pilas Mignon de 1,5 V)

Poignée à piles ø 30 mm (2 piles Mignon, 1,5 volts sont nécessaires)

Manico per pila ø 30 mm (2 pile Mignon di 1,5 volt sono necessarie)



03-203-01  
14,5 cm, 5<sup>3</sup>/<sub>4</sub>"

Battery handle, ø 30 mm (2 Baby Batteries, 1,5 volt, are required)

Batteriegriff ø 30 mm (2 Baby-Zellen, 1,5 Volt, sind erforderlich)

Mango de pila ø 30 mm (se necesitan 2 pilas Mignon de 1,5 V)

Poignée à piles ø 30 mm (2 piles Mignon, 1,5 volts sont nécessaires)

Manico per pila ø 30 mm (2 pile Mignon di 1,5 volt sono necessarie)



03-205-01  
15 cm, 6"

Battery handle, ø 18 mm (2 Mini-Batteries, 1,5 volt, are required)

Batteriegriff ø 18 mm (2 Mini-Zellen, 1,5 Volt, sind erforderlich)

Mango de pila ø 18 mm (se necesitan 2 pilas Mini de 1,5 V)

Poignée à piles ø 18 mm (2 piles Mini, 1,5 volts sont nécessaires)

Manico per pila ø 18 mm (2 pile Mini di 1,5 volt sono necessarie)

## McINTOSH

03-207-01  
03-207-05

Laryngoscope blades  
Laryngoskopie-Spatel  
Espátulas de laringoscopios  
Spatules de laryngoscopie  
Spatole per laringoscopi



03-204-01  
2,5 V



03-204-02  
2,5 V



1/3

**McINTOSH**  
03-207-00

**Laryngoscope set, consisting of:**

- 03-205-02 1 Laryngoscope blade 75 mm Fig.2
- 03-205-03 1 Laryngoscope blade 90 mm Fig.3
- 03-205-04 1 Laryngoscope blade 110 mm Fig.4
- 03-201-01 1 Battery handle, ø 30 mm (without batteries)
- 03-204-03 1 Case

**Laryngoskopie-Besteck, bestehend aus:**

- 03-205-02 1 Laryngoskopie-Spatel 75 mm Fig.2
- 03-205-03 1 Laryngoskopie-Spatel 90 mm Fig.3
- 03-205-04 1 Laryngoskopie-Spatel 110 mm Fig.4
- 03-201-01 1 Batteriegriff ø 30 mm (ohne Batterien)
- 03-204-03 1 Etui

**Juego para laringoscopia, compuesto de:**

- 03-205-02 1 Espátula de laringoscopio 75 mm Fig.2
- 03-205-03 1 Espátula de laringoscopio 90 mm Fig.3
- 03-205-04 1 Espátula de laringoscopio 110 mm Fig.4
- 03-201-01 1 Mango de pila ø 30 mm (sin pilas)
- 03-204-03 1 Estuche

**Trousse à laryngoscopie, composée de:**

- 03-205-02 1 Spatule pour laryngoscopie 75 mm Fig.2
- 03-205-03 1 Spatule pour laryngoscopie 90 mm Fig.3
- 03-205-04 1 Spatule pour laryngoscopie 110 mm Fig.4
- 03-201-01 1 Poignée à piles ø 30 mm (sans piles)
- 03-204-03 1 Boîte

**Set per laringoscopia, composto da:**

- 03-205-02 1 Spatola per laringoscopia 75 mm Fig.2
- 03-205-03 1 Spatola per laringoscopia 90 mm Fig.3
- 03-205-04 1 Spatola per laringoscopia 110 mm Fig.4
- 03-201-01 1 Manico per pila ø 30 mm (senza pila)
- 03-204-03 1 astuccio

**McINTOSH**  
03-208-00

**Laryngoscope set, consisting of:**

- 03-205-02 1 Laryngoscope blade 75 mm Fig.2
- 03-205-03 1 Laryngoscope blade 90 mm Fig.3
- 03-205-04 1 Laryngoscope blade 110 mm Fig.4
- 03-205-05 1 Laryngoscope blade 135 mm Fig.5
- 03-201-01 1 Battery handle, ø 30 mm (without batteries)
- 03-204-03 1 Case

**Laryngoskopie-Besteck, bestehend aus:**

- 03-205-02 1 Laryngoskopie-Spatel 75 mm Fig.2
- 03-205-03 1 Laryngoskopie-Spatel 90 mm Fig.3
- 03-205-04 1 Laryngoskopie-Spatel 110 mm Fig.4
- 03-205-05 1 Laryngoskopie-Spatel 135 mm Fig.5
- 03-201-01 1 Batteriegriff ø 30 mm (ohne Batterien)
- 03-204-03 1 Etui

**Juego para laringoscopia, compuesto de:**

- 03-205-02 1 Espátula de laringoscopio 75 mm Fig.2
- 03-205-03 1 Espátula de laringoscopio 90 mm Fig.3
- 03-205-04 1 Espátula de laringoscopio 110 mm Fig.4
- 03-205-05 1 Espátula de laringoscopio 135 mm Fig.5
- 03-201-01 1 Mango de pila ø 30 mm (sin pilas)
- 03-204-03 1 Estuche

**Trousse à laryngoscopie, composée de:**

- 03-205-02 1 Spatule pour laryngoscopie 75 mm Fig.2
- 03-205-03 1 Spatule pour laryngoscopie 90 mm Fig.3
- 03-205-04 1 Spatule pour laryngoscopie 110 mm Fig.4
- 03-205-05 1 Spatule pour laryngoscopie 135 mm Fig.5
- 03-201-01 1 Poignée à piles ø 30 mm (sans piles)
- 03-204-03 1 Boîte

**Set per laringoscopia, composto da:**

- 03-205-02 1 Spatola per laringoscopia 75 mm Fig.2
- 03-205-03 1 Spatola per laringoscopia 90 mm Fig.3
- 03-205-04 1 Spatola per laringoscopia 110 mm Fig.4
- 03-205-05 1 Spatola per laringoscopia 135 mm Fig.5
- 03-201-01 1 Manico per pila ø 30 mm (senza pila)
- 03-204-03 1 astuccio

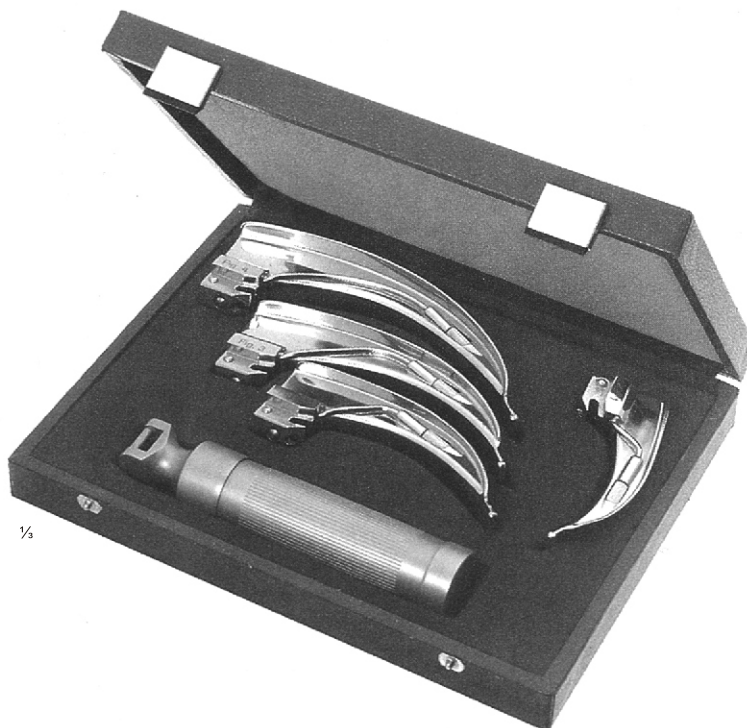

1/3



### Laryngoscopes with Cold Light

Laryngoskope mit Kaltlicht

Laringoscopios de luz fría

Laryngoscopes lumière froide

Laringoscopi luce fredda



03

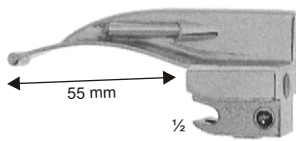

Fig. 1  
03-215-01

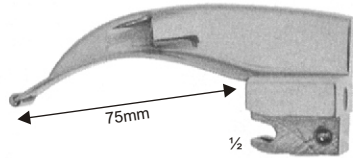

Fig. 2  
03-215-02

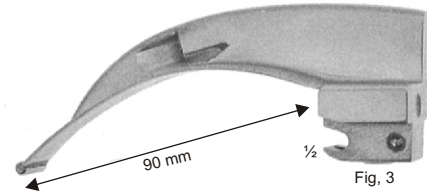

Fig. 3  
03-215-03

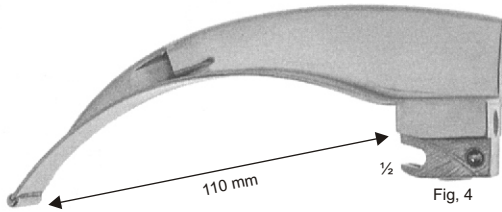

Fig. 4  
03-215-04

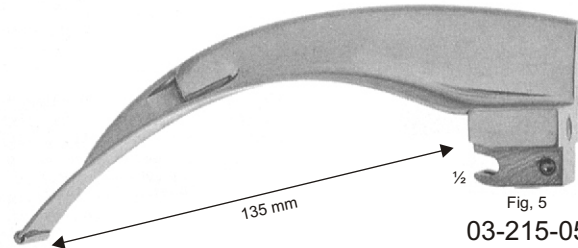

Fig. 5  
03-215-05



03-211-01  
16 cm, 6 1/4"

Battery handle, ø 30 mm (2 Baby batteries, 1,5 volt, are required)

Batteriegriff ø 30 mm (2 Baby-Zellen, 1,5 Volt, sind erforderlich)

Mango de pila ø 30 mm (se necesitan 2 pilas Mignon de 1,5 V)

Poignée à piles ø 30 mm (2 piles Mignon, 1,5 volts sont nécessaires)

Manico per pila ø 30 mm (2 pile Mignon di 1,5 volt sono necessarie)



03-213-01  
16 cm, 6 1/4"

Battery handle, ø 18 mm (2 Mini batteries, 1,5 volt, are required)

Batteriegriff ø 18 mm (2 Mini-Zellen, 1,5 Volt, sind erforderlich)

Mango de pila ø 18 mm (se necesitan 2 pilas Mini de 1,5 V)

Poignée à piles ø 18 mm (2 piles Mini, 1,5 volts sont nécessaires)

Manico per pila ø 18 mm (2 pile Mini di 1,5 volt sono necessarie)

### McINTOSH

03-215-01

03-215-05



Laryngoscope blades with integrated cold light carrier

Laryngoskopie-Spatel mit integriertem Kaltlichtträger

Espátulas de laringoscopios con luz fría integrada

Spatules de laryngoscopie, avec lumière froide intégrée

Spatole per laringoscopia, luce fredda



03-204-05  
2,5 V



03-204-06  
2,5 V

### Halogen Lamp 2,5 V

Halogenlampe 2,5 V

Làmpara halógeno 2,5 V

Lampe halogène 2,5 V



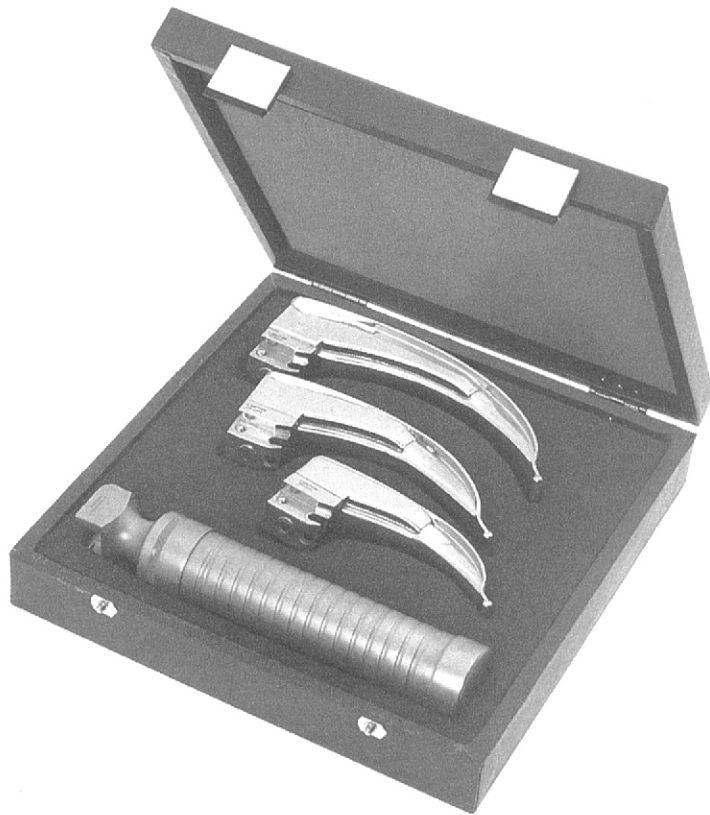

**McINTOSH**  
**03-217-00**

Laryngoscope set, consisting of:

- 03-215-02 1 Blade with cold light 80 mm Fig. 2
- 03-215-03 1 Blade with cold light 105 mm Fig.3
- 03-215-04 1 Blade with cold light 130 mm Fig.4
- 03-211-01 1 Battery Handle, ø 30 mm (without batteries)
- 03-204-03 1 Case

Laryngoskopie-Besteck, bestehend aus:

- 03-215-02 1 Spatel mit Kaltlicht 80 mm Fig. 2
- 03-215-03 1 Spatel mit Kaltlicht 105 mm Fig.3
- 03-215-04 1 Spatel mit Kaltlicht 130 mm Fig.4
- 03-211-01 1 Batteriegriff ø 30 mm (ohne Batterien)
- 03-204-03 1 Etui

Juego para laringoscopia, compuesto de:

- 03-215-02 1 Espátula con luz fría 80 mm Fig. 2
- 03-215-03 1 Espátula con luz fría 105 mm Fig.3
- 03-215-04 1 Espátula con luz fría 130 mm Fig.4
- 03-211-01 1 Mango de pila ø 30 mm (sin pilas)
- 03-204-03 1 Estuche

Trousse à laryngoscopie, composée de:

- 03-215-02 1 Spatule lumière froide 80 mm Fig. 2
- 03-215-03 1 Spatule lumière froide 105 mm Fig.3
- 03-215-04 1 Spatule lumière froide 130 mm Fig.4
- 03-211-01 1 Poignée à piles ø 30 mm (sans piles)
- 03-204-03 1 Boîte

Set per laringoscopia, composto da:

- 03-215-02 1 Spatola con luce fredda 80 mm Fig. 2
- 03-215-03 1 Spatola con luce fredda 105 mm Fig.3
- 03-215-04 1 Spatola con luce fredda 130 mm Fig.4
- 03-211-01 1 Manico per pila ø 30 mm (senza pila)
- 03-204-03 1 astuccio

**McINTOSH**  
**03-218-00**

Laryngoscope set, consisting of:

- 03-215-02 1 Blade with cold light 70 mm Fig. 2
- 03-215-03 1 Blade with cold light 80 mm Fig. 3
- 03-215-04 1 Blade with cold light 105 mm Fig.4
- 03-215-05 1 Blade with cold light 130mm Fig. 5
- 03-211-01 1 Battery Handle, ø 30 mm (without batteries)
- 03-204-03 1 Case

Laryngoskopie-Besteck, bestehend aus:

- 03-215-02 1 Spatel mit Kaltlicht 70 mm Fig. 2
- 03-215-03 1 Spatel mit Kaltlicht 80 mm Fig. 3
- 03-215-04 1 Spatel mit Kaltlicht 105 mm Fig.4
- 03-215-05 1 Spatel mit Kaltlicht 130 mm Fig.5
- 03-211-01 1 Batteriegriff ø 30 mm (ohne Batterien)
- 03-204-03 1 Etui

Juego para laringoscopia, compuesto de:

- 03-215-02 1 Espátula con luz fría 70 mm Fig. 2
- 03-215-03 1 Espátula con luz fría 80 mm Fig. 3
- 03-215-04 1 Espátula con luz fría 105 mm Fig. 4
- 03-215-05 1 Espátula con luz fría 130 mm Fig.5
- 03-211-01 1 Mango de pila ø 30 mm (sin pilas)
- 03-204-03 1 Estuche

Trousse à laryngoscopie, composée de:

- 03-215-02 1 Spatule lumière froide 70 mm Fig. 2
- 03-215-03 1 Spatule lumière froide 80 mm Fig. 3
- 03-215-04 1 Spatule lumière froide 105 mm Fig.4
- 03-215-05 1 Spatule lumière froide 130 mm Fig.5
- 03-211-01 1 Poignée à piles ø 30 mm (sans piles)
- 03-204-03 1 Boîte

Set per laringoscopia, composto da:

- 03-215-02 1 Spatola con luce fredda 70 mm Fig. 2
- 03-215-03 1 Spatola con luce fredda 80 mm Fig. 3
- 03-215-04 1 Spatola con luce fredda 105 mm Fig.4
- 03-215-05 1 Spatola con luce fredda 130 mm Fig.5
- 03-211-01 1 Manico per pila ø 30 mm (senza pila)
- 03-204-03 1 astuccio

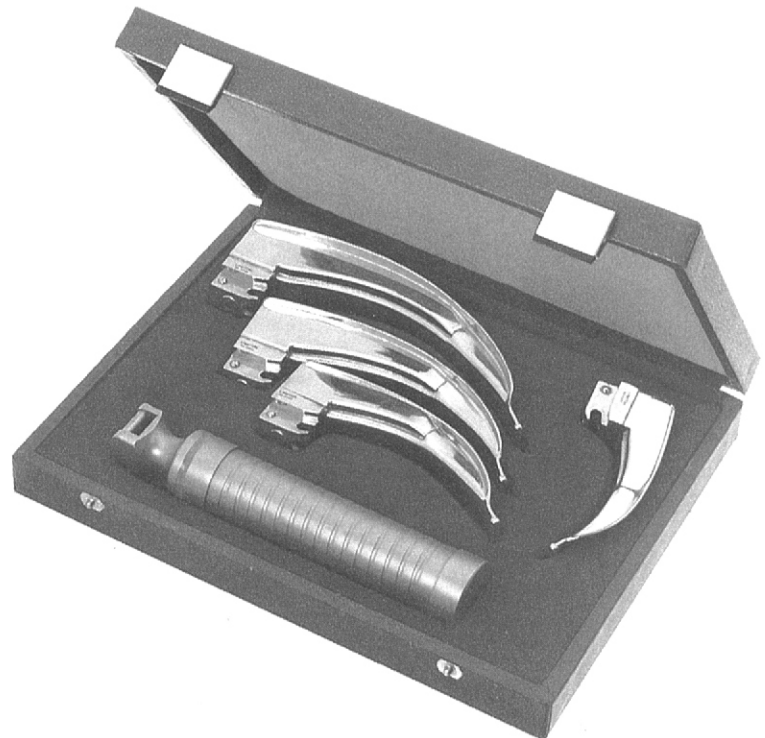





**Laryngoscopes**  
 Laryngoskope  
 Laringoscopios  
 Laryngoscopes  
 Laringoscopi



03

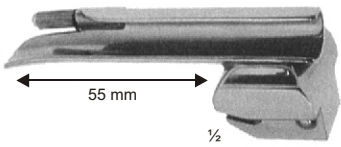

Fig. 1  
03-225-01

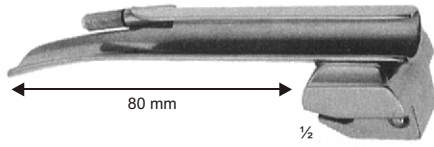

Fig. 2  
03-225-02

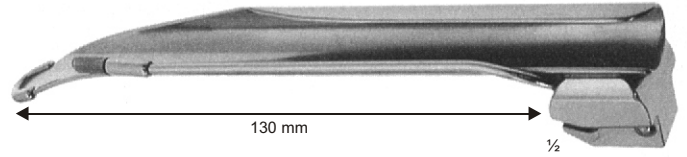

Fig. 3  
03-225-03

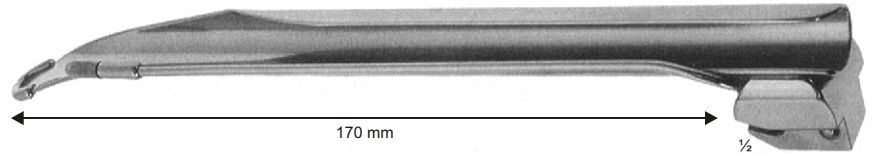

Fig. 4  
03-225-04

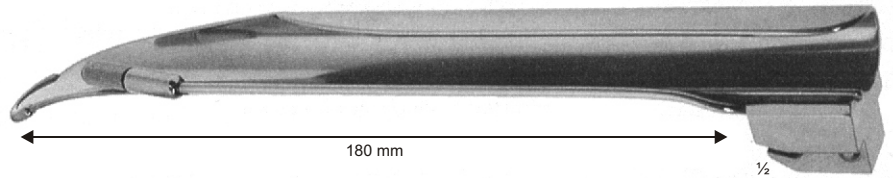
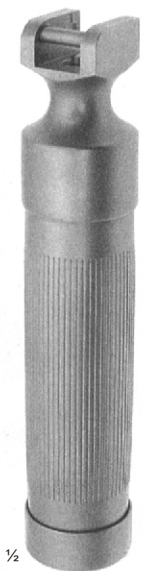

Fig. 5  
03-225-05



03-201-01  
14,5 cm, 5 3/4"

**Battery handle, ø 30 mm (2 Baby Batteries, 1,5 volt, are required)**

Batteriegriff ø 30 mm (2 Baby-Zellen, 1,5 Volt, sind erforderlich)

Mango de pila ø 30 mm (se necesitan 2 pilas Mignon de 1,5 V)

Poignée à piles ø 30 mm (2 piles Mignon, 1,5 volts sont nécessaires)

Manico per pila ø 30 mm (2 pile Mignon di 1,5 volt sono necessarie)



03-203-01  
14,5 cm, 5 3/4"

**Battery handle, ø 30 mm (2 Baby Batteries, 1,5 volt, are required)**

Batteriegriff ø 30 mm (2 Baby-Zellen, 1,5 Volt, sind erforderlich)

Mango de pila ø 30 mm (se necesitan 2 pilas Mignon de 1,5 V)

Poignée à piles ø 30 mm (2 piles Mignon, 1,5 volts sont nécessaires)

Manico per pila ø 30 mm (2 pile Mignon di 1,5 volt sono necessarie)



03-205-01  
15 cm, 6"

**Battery handle, ø 18 mm (2 Mini-Batteries, 1,5 volt, are required)**

Batteriegriff ø 18 mm (2 Mini-Zellen, 1,5 Volt, sind erforderlich)

Mango de pila ø 18 mm (se necesitan 2 pilas Mini de 1,5 V)

Poignée à piles ø 18 mm (2 piles Mini, 1,5 volts sont nécessaires)

Manico per pila ø 18 mm (2 pile Mini di 1,5 volt sono necessarie)

**MILLER**  
03-225-01  
03-225-05

**Laryngoscope blades**  
 Laryngoskopie-Spatel  
 Espátulas de laringoscopios  
 Spatules de laryngoscopie  
 Spatole per laringoscopi



03-204-01  
2,5 V



03-204-02  
2,5 V

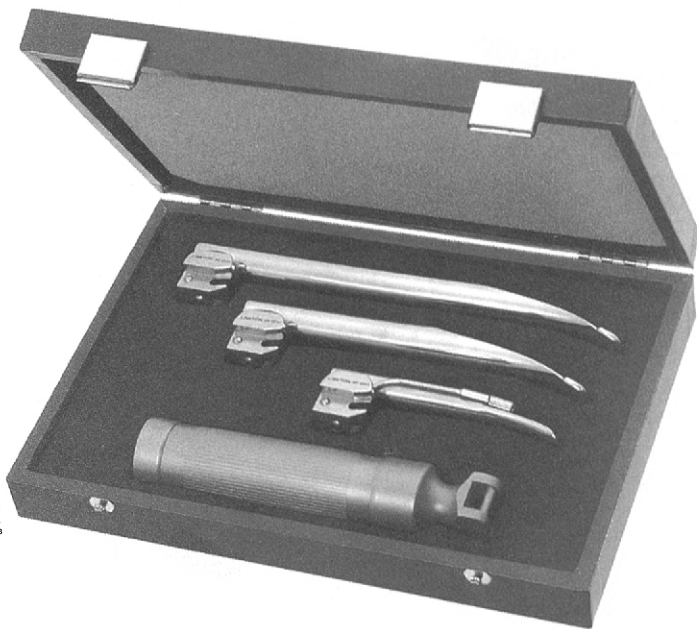

**MILLER**  
**03-227-00**

Laryngoscope set, consisting of:  
03-225-02 1 Laryngoscope blade 80 mm Fig.2  
03-225-03 1 Laryngoscope blade 130 mm Fig.3  
03-225-04 1 Laryngoscope blade 170 mm Fig.4  
03-201-01 1 Battery handle, ø 30 mm (without batteries)  
03-204-03 1 Case

Laryngoskopie-Besteck, bestehend aus:  
03-225-02 1 Laryngoskopie-Spatel 80 mm Fig.2  
03-225-03 1 Laryngoskopie-Spatel 130 mm Fig.3  
03-225-04 1 Laryngoskopie-Spatel 170 mm Fig.4  
03-201-01 1 Batteriegriff ø 30 mm (ohne Batterien)  
03-204-03 1 Etui

Juego para laringoscopia, compuesto de:  
03-225-02 1 Espátula de laringoscopia 80 mm Fig.2  
03-225-03 1 Espátula de laringoscopia 130 mm Fig.3  
03-225-04 1 Espátula de laringoscopia 170 mm Fig.4  
03-201-01 1 Mango de pila ø 30 mm (sin pilas)  
03-204-03 1 Estuche

Trousse à laryngoscopie, composée de:  
03-225-02 1 Spatule pour laryngoscope 80 mm Fig.2  
03-225-03 1 Spatule pour laryngoscope 130 mm Fig.3  
03-225-04 1 Spatule pour laryngoscope 170 mm Fig.4  
03-201-01 1 Poignée à piles ø 30 mm (sans piles)  
03-204-03 1 Boîte

Set per laringoscopia, composto da:  
03-225-02 1 Spatola per laringoscopia 80 mm Fig.2  
03-225-03 1 Spatola per laringoscopia 130 mm Fig.3  
03-225-04 1 Spatola per laringoscopia 170 mm Fig.4  
03-201-01 1 Manico per pila ø 30 mm (senza pila)  
03-204-03 1 astuccio

**MILLER**  
**03-228-00**

Laryngoscope set, consisting of:  
03-225-01 1 Laryngoscope blade 55 mm Fig.1  
03-225-02 1 Laryngoscope blade 80 mm Fig.2  
03-225-03 1 Laryngoscope blade 130 mm Fig.3  
03-225-04 1 Laryngoscope blade 170 mm Fig.4  
03-225-05 1 Laryngoscope blade 180 mm Fig.5  
03-201-01 1 Battery handle, ø 30 mm (without batteries)  
03-204-03 1 Case

Laryngoskopie-Besteck, bestehend aus:  
03-225-01 1 Laryngoskopie-Spatel 55 mm Fig.1  
03-225-02 1 Laryngoskopie-Spatel 80 mm Fig.2  
03-225-03 1 Laryngoskopie-Spatel 130 mm Fig.3  
03-225-04 1 Laryngoskopie-Spatel 170 mm Fig.4  
03-225-05 1 Laryngoskopie-Spatel 180 mm Fig.5  
03-201-01 1 Batteriegriff ø 30 mm (ohne Batterien)  
03-204-03 1 Etui

Juego para laringoscopia, compuesto de:  
03-225-01 1 Espátula de laringoscopia 55 mm Fig.1  
03-225-02 1 Espátula de laringoscopia 80 mm Fig.2  
03-225-03 1 Espátula de laringoscopia 130 mm Fig.3  
03-225-04 1 Espátula de laringoscopia 170 mm Fig.4  
03-225-05 1 Espátula de laringoscopia 180 mm Fig.5  
03-201-01 1 Mango de pila ø 30 mm (sin pilas)  
03-204-03 1 Estuche

Trousse à laryngoscopie, composée de:  
03-225-01 1 Spatule pour laryngoscope 55 mm Fig.1  
03-225-02 1 Spatule pour laryngoscope 80 mm Fig.2  
03-225-03 1 Spatule pour laryngoscope 130 mm Fig.3  
03-225-04 1 Spatule pour laryngoscope 170 mm Fig.4  
03-225-05 1 Spatule pour laryngoscope 180 mm Fig.5  
03-201-01 1 Poignée à piles ø 30 mm (sans piles)  
03-204-03 1 Boîte

Set per laringoscopia, composto da:  
03-225-01 1 Spatola per laringoscopia 55 mm Fig.1  
03-225-02 1 Spatola per laringoscopia 80 mm Fig.2  
03-225-03 1 Spatola per laringoscopia 130 mm Fig.3  
03-225-04 1 Spatola per laringoscopia 170 mm Fig.4  
03-225-05 1 Spatola per laringoscopia 180 mm Fig.5  
03-201-01 1 Manico per pila ø 30 mm (senza pila)  
03-204-03 1 astuccio





## Laryngoscopes with Cold Light

Laryngoskope mit Kaltlicht  
Laringoscopios de luz fría  
Laryngoscopes lumière froide  
Laringoscopi luce fredda



03

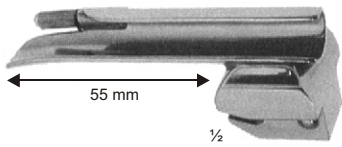

1/2

Fig. 1

03-235-01

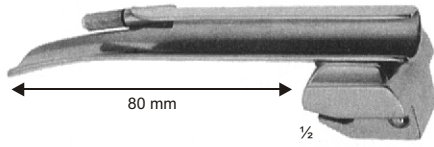

1/2

Fig. 2

03-235-02

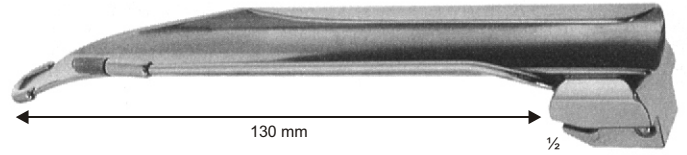

1/2

Fig. 3

03-235-03

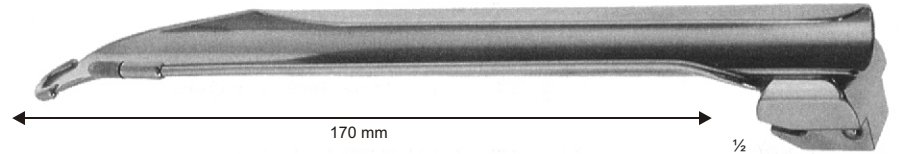

1/2

Fig. 4

03-235-04

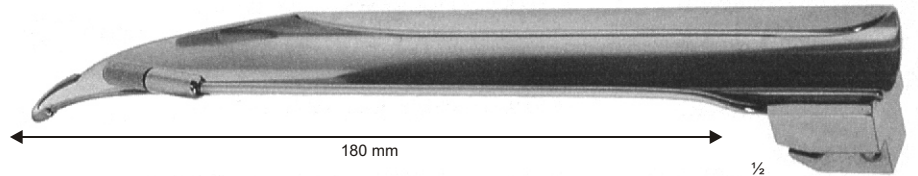

1/2

Fig. 5

03-235-05



1/2

03-211-01  
14,5 cm, 5 3/4"

**Battery handle, ø 30 mm (2 Baby Batteries, 1,5 volt, are required)**

Batteriegriff ø 30 mm (2 Baby-Zellen, 1,5 Volt, sind erforderlich)

Mango de pila ø 30 mm (se necesitan 2 pilas Mignon de 1,5 V)

Poignée à piles ø 30 mm (2 piles Mignon, 1,5 volts sont nécessaires)

Manico per pila ø 30 mm (2 pile Mignon di 1,5 volt sono necessarie)



1/2

03-213-03  
15 cm, 6"

**Battery handle, ø 18 mm (2 Mini-Batteries, 1,5 volt, are required)**

Batteriegriff ø 18 mm (2 Mini-Zellen, 1,5 Volt, sind erforderlich)

Mango de pila ø 18 mm (se necesitan 2 pilas Mini de 1,5 V)

Poignée à piles ø 18 mm (2 piles Mini, 1,5 volts sont nécessaires)

Manico per pila ø 18 mm (2 pile Mini di 1,5 volt sono necessarie)

MILLER  
03-235-01  
03-235-05



**Laryngoscope blades with integrated cold light carrier**  
Laryngoskopie-Spatel mit integriertem Kaltlichtträger  
Espátulas de laringoscopios con luz fría integrada  
Spatules de laryngoscopie, avec lumière froide intégrée  
Spatole per laringoscopia, luce fredda



1/4

03-204-05  
2,5 V



1/4

03-204-06  
2,5 V

**Halogen Lamp 2,5 V**  
Halogenlampe 2,5 V  
Làmpara halógeno 2,5 V  
Lampe halogène 2,5 V





**MILLER**  
**03-237-00**

Laryngoscope set, consisting of:

- 03-235-02 1 Laryngoscope blade 80 mm Fig,2
- 03-235-03 1 Laryngoscope blade 130 mm Fig,3
- 03-235-04 1 Laryngoscope blade 170 mm Fig,4
- 03-211-01 1 Battery handle, ø 30 mm (without batteries)
- 03-204-03 1 Case

Laryngoskopie-Besteck, bestehend aus:

- 03-235-02 1 Laryngoskopie-Spatel 80 mm Fig,2
- 03-235-03 1 Laryngoskopie-Spatel 130 mm Fig,3
- 03-235-04 1 Laryngoskopie-Spatel 170 mm Fig,4
- 03-211-01 1 Batteriegriff ø 30 mm (ohne Batterien)
- 03-204-03 1 Etui

Juego para laringoscopia, compuesto de:

- 03-235-02 1 Espátula de laringoscopio 80 mm Fig,2
- 03-235-03 1 Espátula de laringoscopio 130 mm Fig,3
- 03-235-04 1 Espátula de laringoscopio 170 mm Fig,4
- 03-211-01 1 Mango de pila ø 30 mm (sin pilas)
- 03-204-03 1 Estuche

Trousse à laryngoscopie, composée de:

- 03-235-02 1 Spatule pour laryngoscopie 80 mm Fig,2
- 03-235-03 1 Spatule pour laryngoscopie 130 mm Fig,3
- 03-235-04 1 Spatule pour laryngoscopie 170 mm Fig,4
- 03-211-01 1 Poignée à piles ø 30 mm (sans piles)
- 03-204-03 1 Boîte

Set per laringoscopia, composto da:

- 03-235-02 1 Spatola per laringoscopia 80 mm Fig,2
- 03-235-03 1 Spatola per laringoscopia 130 mm Fig,3
- 03-235-04 1 Spatola per laringoscopia 170 mm Fig,4
- 03-211-01 1 Manico per pila ø 30 mm (senza pila)
- 03-204-03 1 astuccio



**MILLER**  
**03-238-00**

Laryngoscope set, consisting of:

- 03-235-01 1 Laryngoscope blade 55 mm Fig,1
- 03-235-02 1 Laryngoscope blade 80 mm Fig,2
- 03-235-03 1 Laryngoscope blade 130 mm Fig,3
- 03-235-04 1 Laryngoscope blade 170 mm Fig,4
- 03-235-05 1 Laryngoscope blade 180 mm Fig,5
- 03-211-01 1 Battery handle, ø 30 mm (without batteries)
- 03-204-03 1 Case

Laryngoskopie-Besteck, bestehend aus:

- 03-235-01 1 Laryngoskopie-Spatel 55 mm Fig,1
- 03-235-02 1 Laryngoskopie-Spatel 80 mm Fig,2
- 03-235-03 1 Laryngoskopie-Spatel 130 mm Fig,3
- 03-235-04 1 Laryngoskopie-Spatel 170 mm Fig,4
- 03-235-05 1 Laryngoskopie-Spatel 180 mm Fig,5
- 03-211-01 1 Batteriegriff ø 30 mm (ohne Batterien)
- 03-204-03 1 Etui

Juego para laringoscopia, compuesto de:

- 03-235-01 1 Espátula de laringoscopio 55 mm Fig,1
- 03-235-02 1 Espátula de laringoscopio 80 mm Fig,2
- 03-235-03 1 Espátula de laringoscopio 130 mm Fig,3
- 03-235-04 1 Espátula de laringoscopio 170 mm Fig,4
- 03-235-05 1 Espátula de laringoscopio 180 mm Fig,5
- 03-211-01 1 Mango de pila ø 30 mm (sin pilas)
- 03-204-03 1 Estuche

Trousse à laryngoscopie, composée de:

- 03-235-01 1 Spatule pour laryngoscopie 55 mm Fig,1
- 03-235-02 1 Spatule pour laryngoscopie 80 mm Fig,2
- 03-235-03 1 Spatule pour laryngoscopie 130 mm Fig,3
- 03-235-04 1 Spatule pour laryngoscopie 170 mm Fig,4
- 03-235-05 1 Spatule pour laryngoscopie 180 mm Fig,5
- 03-211-01 1 Poignée à piles ø 30 mm (sans piles)
- 03-204-03 1 Boîte

Set per laringoscopia, composto da:

- 03-235-01 1 Spatola per laringoscopia 55 mm Fig,1
- 03-235-02 1 Spatola per laringoscopia 80 mm Fig,2
- 03-235-03 1 Spatola per laringoscopia 130 mm Fig,3
- 03-235-04 1 Spatola per laringoscopia 170 mm Fig,4
- 03-235-05 1 Spatola per laringoscopia 180 mm Fig,5
- 03-211-01 1 Manico per pila ø 30 mm (senza pila)
- 03-204-03 1 astuccio





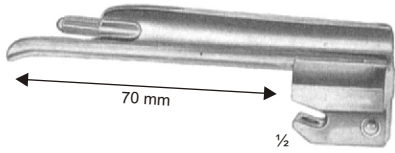

Fig. 1  
03-245-01

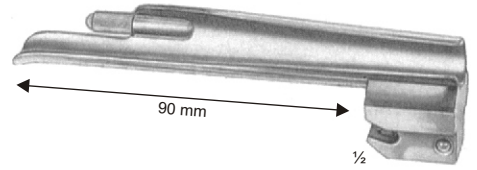

Fig. 2  
03-245-02

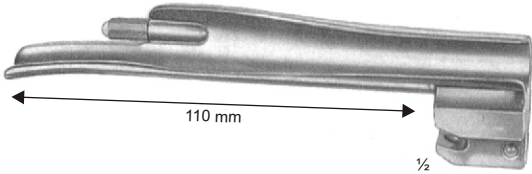

Fig. 2  
03-245-03

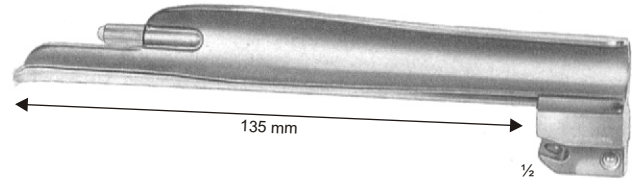
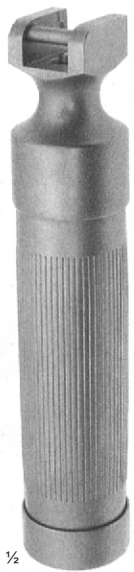

Fig. 4  
03-245-04

**FOREGGER**

03-245-01  
03-245-04

**Laryngoscope blades**  
 Laryngoskopie-Spatel  
 Espátulas de laringoscopio  
 Spatules de laryngoscopie  
 Spatole per laringoscopi



03-201-01  
14,5 cm, 5¾"

**Battery handle, ø 30 mm (2 Baby Batteries, 1,5 volt, are required)**

Batteriegriff ø 30 mm (2 Baby-Zellen, 1,5 Volt, sind erforderlich)

Mango de pila ø 30 mm (se necesitan 2 pilas Mignon de 1,5 V)

Poignée e à piles ø 30 mm (2 piles Mignon, 1,5 volts sont nécessaires)

Manico per pila ø 30 mm (2 pile Mignon di 1,5 volt sono necessarie)



03-203-01  
14,5 cm, 5¾"

**Battery handle, ø 30 mm (2 Baby Batteries, 1,5 volt, are required)**

Batteriegriff ø 30 mm (2 Baby-Zellen, 1,5 Volt, sind erforderlich)

Mango de pila ø 30 mm (se necesitan 2 pilas Mignon de 1,5 V)

Poignée e à piles ø 30 mm (2 piles Mignon, 1,5 volts sont nécessaires)

Manico per pila ø 30 mm (2 pile Mignon di 1,5 volt sono necessarie)



03-205-01  
15 cm, 6"

**Battery handle, ø 18 mm (2 Mini-Batteries, 1,5 volt, are required)**

Batteriegriff ø 18 mm (2 Mini-Zellen, 1,5 Volt, sind erforderlich)

Mango de pila ø 18 mm (se necesitan 2 pilas Mini de 1,5 V)

Poigné e à piles ø 18 mm (2 piles Mini, 1,5 volts sont nécessaires)

Manico per pila ø 18 mm (2 pile Mini di 1,5 volt sono necessarie)



03-204-01  
2,5 V



03-204-02  
2,5 V



**FOREGGER**  
 03-248-00

Laryngoscope set, consisting of:

- 03-245-01 1 Laryngoscope blade 70 mm Fig,1
- 03-245-02 1 Laryngoscope blade 90 mm Fig,2
- 03-245-03 1 Laryngoscope blade 110 mm Fig,3
- 03-245-04 1 Laryngoscope blade 135 mm Fig,4
- 03-201-01 1 Battery handle, ø 30 mm (without batteries)
- 03-204-03 1 Case

Laryngoskopie-Besteck, bestehend aus:

- 03-245-01 1 Laryngoskopie-Spatel 70 mm Fig,1
- 03-245-02 1 Laryngoskopie-Spatel 90 mm Fig,2
- 03-245-03 1 Laryngoskopie-Spatel 110 mm Fig,3
- 03-245-04 1 Laryngoskopie-Spatel 135 mm Fig,4
- 03-201-01 1 Batteriegriff ø 30 mm (ohne Batterien)
- 03-204-03 1 Etui

Juego para laringoscopia, compuesto de:

- 03-245-01 1 Espátula de laringoscopia 70 mm Fig,1
- 03-245-02 1 Espátula de laringoscopia 90 mm Fig,2
- 03-245-03 1 Espátula de laringoscopia 110 mm Fig,3
- 03-245-04 1 Espátula de laringoscopia 135 mm Fig,4
- 03-201-01 1 Mango de pila ø 30 mm (sin pilas)
- 03-204-03 1 Estuche

Trousse à laryngoscopie, composée de:

- 03-245-01 1 Spatule pour laryngoscopie 70 mm Fig,1
- 03-245-02 1 Spatule pour laryngoscopie 90 mm Fig,2
- 03-245-03 1 Spatule pour laryngoscopie 110 mm Fig,3
- 03-245-04 1 Spatule pour laryngoscopie 135 mm Fig,4
- 03-201-01 1 Poignée à piles ø 30 mm (sans piles)
- 03-204-03 1 Boîte

Set per laringoscopia, composto da:

- 03-245-01 1 Spatola per laringoscopia 70 mm Fig,1
- 03-245-02 1 Spatola per laringoscopia 90 mm Fig,2
- 03-245-03 1 Spatola per laringoscopia 110 mm Fig,3
- 03-245-04 1 Spatola per laringoscopia 135 mm Fig,4
- 03-201-01 1 Manico per pila ø 30 mm (senza pila)
- 03-204-03 1 astuccio

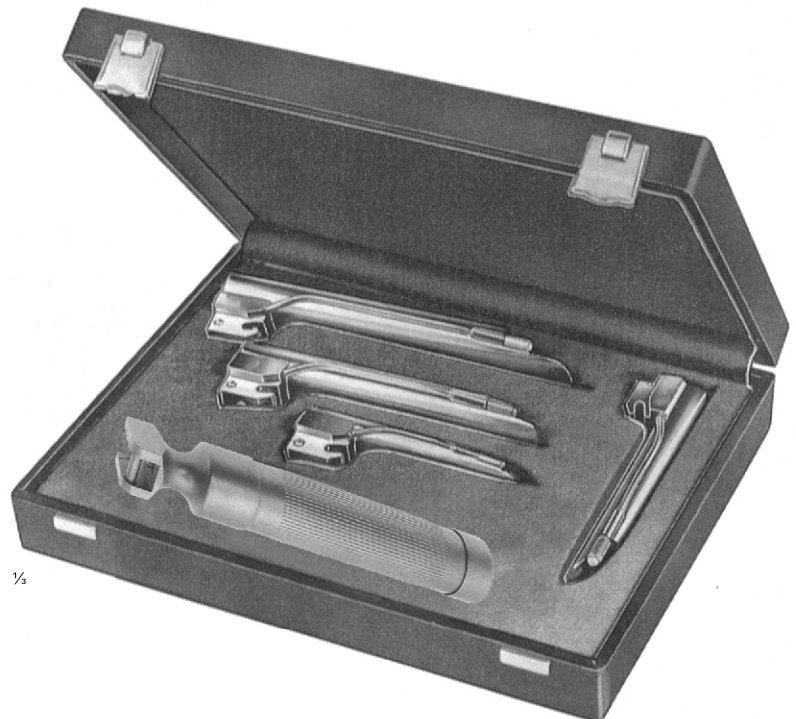

**FOREGGER**  
 03-247-00

Laryngoscope set, consisting of:

- 03-245-02 1 Laryngoscope blade 90 mm Fig,2
- 03-245-03 1 Laryngoscope blade 110 mm Fig,3
- 03-245-04 1 Laryngoscope blade 135 mm Fig,4
- 03-201-01 1 Battery handle, ø 30 mm (without batteries)
- 03-204-03 1 Case

Laryngoskopie-Besteck, bestehend aus:

- 03-245-02 1 Laryngoskopie-Spatel 90 mm Fig,2
- 03-245-03 1 Laryngoskopie-Spatel 110 mm Fig,3
- 03-245-04 1 Laryngoskopie-Spatel 135 mm Fig,4
- 03-201-01 1 Batteriegriff ø 30 mm (ohne Batterien)
- 03-204-03 1 Etui

Juego para laringoscopia, compuesto de:

- 03-245-02 1 Espátula de laringoscopia 90 mm Fig,2
- 03-245-03 1 Espátula de laringoscopia 110 mm Fig,3
- 03-245-04 1 Espátula de laringoscopia 135 mm Fig,4
- 03-201-01 1 Mango de pila ø 30 mm (sin pilas)
- 03-204-03 1 Estuche

Trousse à laryngoscopie, composée de:

- 03-245-02 1 Spatule pour laryngoscopie 90 mm Fig,2
- 03-245-03 1 Spatule pour laryngoscopie 110 mm Fig,3
- 03-245-04 1 Spatule pour laryngoscopie 135 mm Fig,4
- 03-201-01 1 Poignée à piles ø 30 mm (sans piles)
- 03-204-03 1 Boîte

Set per laringoscopia, composto da:

- 03-245-02 1 Spatola per laringoscopia 90 mm Fig,2
- 03-245-03 1 Spatola per laringoscopia 110 mm Fig,3
- 03-245-04 1 Spatola per laringoscopia 135 mm Fig,4
- 03-201-01 1 Manico per pila ø 30 mm (senza pila)
- 03-204-03 1 astuccio



## Laryngoscopes with Cold Light

Laryngoskope mit Kaltlicht  
Laringoscopios de luz fría  
Laryngoscopes lumière froide  
Laringoscopi luce fredda



03

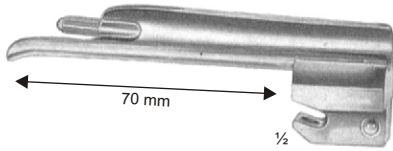

Fig. 1  
03-255-01

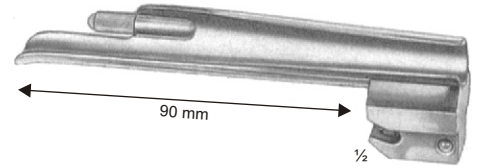

Fig. 2  
03-255-02

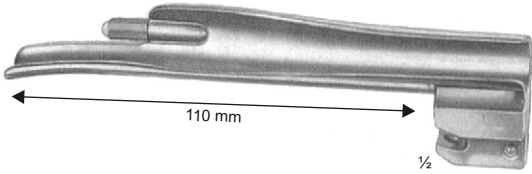

Fig. 3  
03-255-03

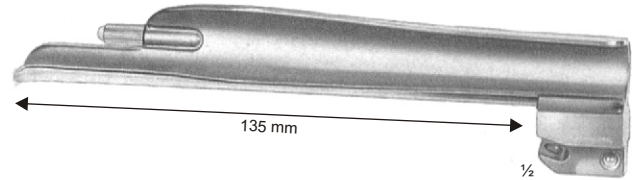

Fig. 4  
03-255-04



03-211-01  
16 cm, 6 1/4"

Battery handle, ø 30 mm (2 Baby batteries, 1,5 volt, are required)

Batteriegriff ø 30 mm (2 Baby-Zellen, 1,5 Volt, sind erforderlich)

Mango de pila ø 30 mm (se necesitan 2 pilas Mignon de 1,5 V)

Poignée à piles ø 30 mm (2 piles Mignon, 1,5 volts sont nécessaires)

Manico per pila ø 30 mm (2 pile Mignon di 1,5 volt sono necessarie)



03-213-03  
16 cm, 6 1/4"

Battery handle, ø 18 mm (2 Mini batteries, 1,5 volt, are required)

Batteriegriff ø 18 mm (2 Mini-Zellen, 1,5 Volt, sind erforderlich)

Mango de pila ø 18 mm (se necesitan 2 pilas Mini de 1,5 V)

Poignée à piles ø 18 mm (2 piles Mini, 1,5 volts sont nécessaires)

Manico per pila ø 18 mm (2 pile Mini di 1,5 volt sono necessarie)

## FOREGGER

03-255-01  
03-255-04



Laryngoscope blades with integrated cold light carrier  
Laryngoskopie-Spatel mit integriertem Kaltlichtträger  
Espátulas de laringoscopios con luz fría integrada  
Spatules de laryngoscopie, avec lumière froide intégrée  
Spatole per laringoscopia, luce fredda



03-204-05  
2,5 V



03-204-06  
2,5 V

Halogen Lamp 2,5 V  
Halogenlampe 2,5 V  
Làmpara halógeno 2,5 V  
Lampe halogène 2,5 V





**FOREGGER**  
 03-258-00

Laryngoscope set, consisting of:

- 03-255-01 1 Laryngoscope blade 70 mm Fig.1
- 03-255-02 1 Laryngoscope blade 90 mm Fig.2
- 03-255-03 1 Laryngoscope blade 110 mm Fig.3
- 03-255-04 1 Laryngoscope blade 135 mm Fig.4
- 03-211-01 1 Battery handle, ø 30 mm (without batteries)
- 03-204-03 1 Case

Laryngoskopie-Besteck, bestechend aus:

- 03-255-01 1 Laryngoskopie-Spatel 70 mm Fig.1
- 03-255-02 1 Laryngoskopie-Spatel 90 mm Fig.2
- 03-255-03 1 Laryngoskopie-Spatel 110 mm Fig.3
- 03-255-04 1 Laryngoskopie-Spatel 135 mm Fig.4
- 03-211-01 1 Batteriegriff ø 30 mm (ohne Batterien)
- 03-204-03 1 Etui

Juego para laringoscopia, compuesto de:

- 03-255-01 1 Espátula de laringoscopia 70 mm Fig.1
- 03-255-02 1 Espátula de laringoscopia 90 mm Fig.2
- 03-255-03 1 Espátula de laringoscopia 110 mm Fig.3
- 03-255-04 1 Espátula de laringoscopia 135 mm Fig.4
- 03-211-01 1 Mango de pila ø 30 mm (sin pilas)
- 03-204-03 1 Estuche

Trousse à laryngoscopie, composée de:

- 03-255-01 1 Spatule pour laryngoscope 70 mm Fig.1
- 03-255-02 1 Spatule pour laryngoscope 90 mm Fig.2
- 03-255-03 1 Spatule pour laryngoscope 110 mm Fig.3
- 03-255-04 1 Spatule pour laryngoscope 135 mm Fig.4
- 03-211-01 1 Poignée à piles ø 30 mm (sans piles)
- 03-204-03 1 Boîte

Set per laringoscopia composto da:

- 03-255-01 1 Spatola per laringoscopia 70 mm Fig.1
- 03-255-02 1 Spatola per laringoscopia 90 mm Fig.2
- 03-255-03 1 Spatola per laringoscopia 110 mm Fig.3
- 03-255-04 1 Spatola per laringoscopia 135 mm Fig.4
- 03-211-01 1 Manico per pila ø 30 mm (senza pila)
- 03-204-03 1 astuccio



**FOREGGER**  
 03-257-00

Laryngoscope set, consisting of:

- 03-255-02 1 Laryngoscope blade 90 mm Fig.2
- 03-255-03 1 Laryngoscope blade 110 mm Fig.3
- 03-255-04 1 Laryngoscope blade 135 mm Fig.4
- 03-211-01 1 Battery handle, ø 30 mm (without batteries)
- 03-204-03 1 Case

Laryngoskopie-Besteck, bestechend aus:

- 03-255-02 1 Laryngoskopie-Spatel 90 mm Fig.2
- 03-255-03 1 Laryngoskopie-Spatel 110 mm Fig.3
- 03-255-04 1 Laryngoskopie-Spatel 135 mm Fig.4
- 03-211-01 1 Batteriegriff ø 30 mm (ohne Batterien)
- 03-204-03 1 Etui

Juego para laringoscopia, compuesto de:

- 03-255-02 1 Espátula de laringoscopia 90 mm Fig.2
- 03-255-03 1 Espátula de laringoscopia 110 mm Fig.3
- 03-255-04 1 Espátula de laringoscopia 135 mm Fig.4
- 03-211-01 1 Mango de pila ø 30 mm (sin pilas)
- 03-204-03 1 Estuche

Trousse à laryngoscopie, composée de:

- 03-255-02 1 Spatule pour laryngoscope 90 mm Fig.2
- 03-255-03 1 Spatule pour laryngoscope 110 mm Fig.3
- 03-255-04 1 Spatule pour laryngoscope 135 mm Fig.4
- 03-211-01 1 Poignée à piles ø 30 mm (sans piles)
- 03-204-03 1 Boîte

Set per laringoscopia composto da:

- 03-255-02 1 Spatola per laringoscopia 90 mm Fig.2
- 03-255-03 1 Spatola per laringoscopia 110 mm Fig.3
- 03-255-04 1 Spatola per laringoscopia 135 mm Fig.4
- 03-211-01 1 Manico per pila ø 30 mm (senza pila)
- 03-204-03 1 astuccio



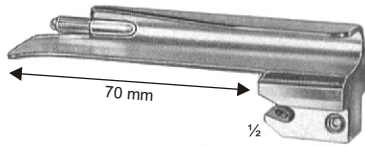

Fig.1  
03-265-01

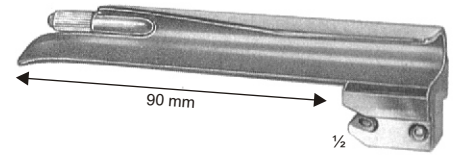

Fig.2  
03-265-02

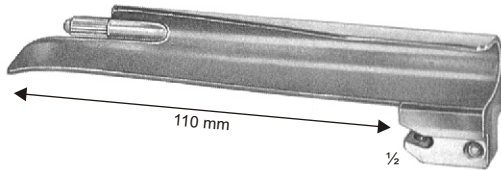

Fig.3  
03-265-03

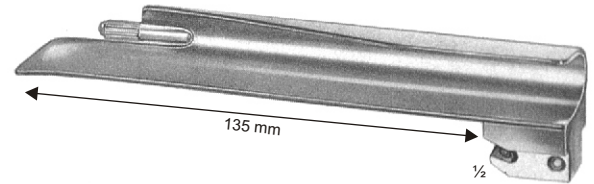
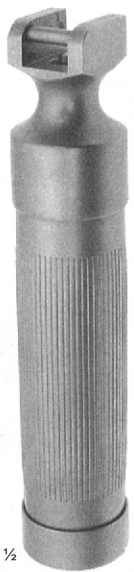

Fig.4  
03-265-04



03-201-01  
14,5 cm, 5¾"

**Battery handle, ø 30 mm (2 Baby Batteries, 1,5 volt, are required)**

Batteriegriff ø 30 mm (2 Baby-Zellen, 1,5 Volt, sind erforderlich)

Mango de pila ø 30 mm (se necesitan 2 pilas Mignon de 1,5 V)

Poignée à piles ø 30 mm (2 piles Mignon, 1,5 volts sont nécessaires)

Manico per pila ø 30 mm (2 pile Mignon di 1,5 volt sono necessarie)

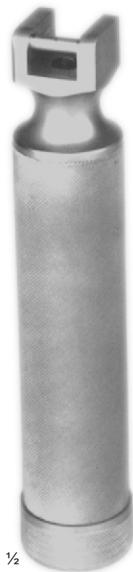

03-203-01  
14,5 cm, 5¾"

**Battery handle, ø 30 mm (2 Baby Batteries, 1,5 volt, are required)**

Batteriegriff ø 30 mm (2 Baby-Zellen, 1,5 Volt, sind erforderlich)

Mango de pila ø 30 mm (se necesitan 2 pilas Mignon de 1,5 V)

Poignée à piles ø 30 mm (2 piles Mignon, 1,5 volts sont nécessaires)

Manico per pila ø 30 mm (2 pile Mignon di 1,5 volt sono necessarie)



03-205-01  
15 cm, 6"

**Battery handle, ø 18 mm (2 Mini-Batteries, 1,5 volt, are required)**

Batteriegriff ø 18 mm (2 Mini-Zellen, 1,5 Volt, sind erforderlich)

Mango de pila ø 18 mm (se necesitan 2 pilas Mini de 1,5 V)

Poignée à piles ø 18 mm (2 piles Mini, 1,5 volts sont nécessaires)

Manico per pila ø 18 mm (2 pile Mini di 1,5 volt sono necessarie)

**GUEDEL-NEGUS**  
03-265-01  
03-265-04

**Laryngoscope blades**  
 Laryngoskopie-Spatel  
 Espátulas de laringoscopios  
 Spatules de laryngoscopes  
 Spatole per laringoscopi



03-264-01  
2,5 V



03-264-02  
2,5 V



**GUEDEL NEGUS**  
 03-267-00

Laryngoscope set, consisting of:

- 03-265-02 1 Laryngoscope blade 90 mm Fig.2
- 03-265-03 1 Laryngoscope blade 110 mm Fig.3
- 03-265-04 1 Laryngoscope blade 135 mm Fig.4
- 03-201-01 1 Battery handle, ø 30 mm (without batteries)
- 03-204-03 1 Case

Laryngoskopie-Besteck, bestehend aus:

- 03-265-02 1 Laryngoskopie-Spatel 90 mm Fig.2
- 03-265-03 1 Laryngoskopie-Spatel 110 mm Fig.3
- 03-265-04 1 Laryngoskopie-Spatel 135 mm Fig.4
- 03-201-01 1 Batteriegriff ø 30 mm (ohne Batterien)
- 03-204-03 1 Etui

Juego para laringoscopia, compuesto de:

- 03-265-02 1 Espátula de laringoscopia 90 mm Fig.2
- 03-265-03 1 Espátula de laringoscopia 110 mm Fig.3
- 03-265-04 1 Espátula de laringoscopia 135 mm Fig.4
- 03-201-01 1 Mango de pila ø 30 mm (sin pilas)
- 03-204-03 1 Estuche

Trousse à laryngoscopie, composée de:

- 03-265-02 1 Spatule pour laryngoscopie 90 mm Fig.2
- 03-265-03 1 Spatule pour laryngoscopie 110 mm Fig.3
- 03-265-04 1 Spatule pour laryngoscopie 135 mm Fig.4
- 03-201-01 1 Poignée à piles ø 30 mm (sans piles)
- 03-204-03 1 Boîte

Set per laringoscopia, composto da:

- 03-265-02 1 Spatola per laringoscopia 90 mm Fig.2
- 03-265-03 1 Spatola per laringoscopia 110 mm Fig.3
- 03-265-04 1 Spatola per laringoscopia 135 mm Fig.4
- 03-201-01 1 Manico per pila ø 30 mm (senza pila)
- 03-204-03 1 astuccio

**GUEDEL NEGUS**  
 03-268-00

Laryngoscope set, consisting of:

- 03-265-01 1 Laryngoscope blade 70 mm Fig.1
- 03-265-02 1 Laryngoscope blade 90 mm Fig.2
- 03-265-03 1 Laryngoscope blade 110 mm Fig.3
- 03-265-04 1 Laryngoscope blade 135 mm Fig.4
- 03-201-01 1 Battery handle, ø 30 mm (without batteries)
- 03-204-03 1 Case

Laryngoskopie-Besteck, bestehend aus:

- 03-265-01 1 Laryngoskopie-Spatel 70 mm Fig.1
- 03-265-02 1 Laryngoskopie-Spatel 90 mm Fig.2
- 03-265-03 1 Laryngoskopie-Spatel 110 mm Fig.3
- 03-265-04 1 Laryngoskopie-Spatel 135 mm Fig.4
- 03-201-01 1 Batteriegriff ø 30 mm (ohne Batterien)
- 03-204-03 1 Etui

Juego para laringoscopia, compuesto de:

- 03-265-01 1 Espátula de laringoscopia 70 mm Fig.1
- 03-265-02 1 Espátula de laringoscopia 90 mm Fig.2
- 03-265-03 1 Espátula de laringoscopia 110 mm Fig.3
- 03-265-04 1 Espátula de laringoscopia 135 mm Fig.4
- 03-201-01 1 Mango de pila ø 30 mm (sin pilas)
- 03-204-03 1 Estuche

Trousse à laryngoscopie, composée de:

- 03-265-01 1 Spatule pour laryngoscopie 70 mm Fig.1
- 03-265-02 1 Spatule pour laryngoscopie 90 mm Fig.2
- 03-265-03 1 Spatule pour laryngoscopie 110 mm Fig.3
- 03-265-04 1 Spatule pour laryngoscopie 135 mm Fig.4
- 03-201-01 1 Poignée à piles ø 30 mm (sans piles)
- 03-204-03 1 Boîte

Set per laringoscopia, composto da:

- 03-265-01 1 Spatola per laringoscopia 70 mm Fig.1
- 03-265-02 1 Spatola per laringoscopia 90 mm Fig.2
- 03-265-03 1 Spatola per laringoscopia 110 mm Fig.3
- 03-265-04 1 Spatola per laringoscopia 135 mm Fig.4
- 03-201-01 1 Manico per pila ø 30 mm (senza pila)
- 03-204-03 1 astuccio

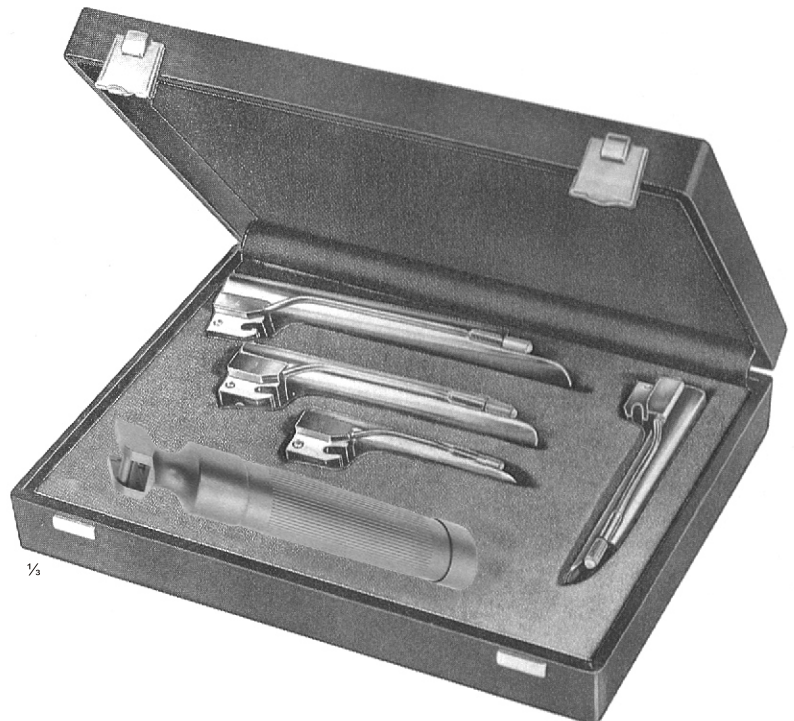



**Laryngoscopes with Cold Light**  
 Laryngoskope mit Kaltlicht  
 Laringoscopios de luz fría  
 Laryngoscopes lumière froide  
 Laringoscopi luce fredda



03

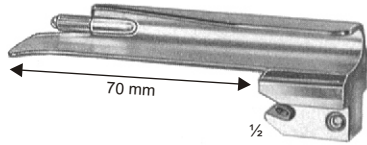

Fig.1  
03-275-01

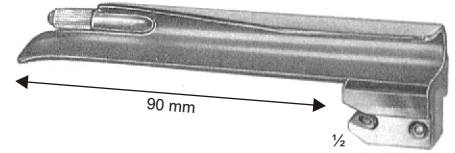

Fig.2  
03-275-02

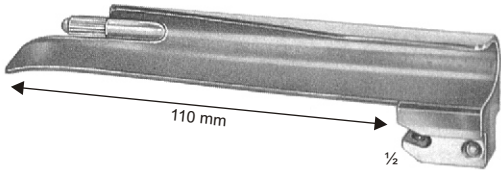

Fig.3  
03-275-03

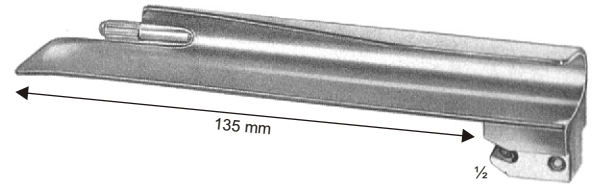

Fig.4  
03-275-04

**GUEDEL-NEGUS**  
 03-275-01  
 03-275-04



**Laryngoscope blades with integrated cold light carrier**  
 Laryngoskopie-Spatel mit integriertem Kaltlichtträger  
 Espátulas de laringoscopios con luz fría integrada  
 Spatules de laryngoscopie, avec lumière froide intè  
 Spatole per laringoscopia, luce fredda



03-272-01  
16 cm, 6¼"

Battery handle, ø 30 mm (2 Baby batteries, 1,5 volt, are required)

Batteriegriff ø 30 mm (2 Baby-Zellen, 1,5 Volt, sind erforderlich)

Mango de pila ø 30 mm (se necesitan 2 pilas Mignon de 1,5 V)

Poignée à piles ø 30 mm (2 piles Mignon, 1,5 volts sont nécessaires)

Manico per pila ø 30 mm (2 pile Mignon di 1,5 volt sono necessarie)



03-272-03  
16 cm, 6¼"

Battery handle, ø 18 mm (2 Mini batteries, 1,5 volt, are required)

Batteriegriff ø 18 mm (2 Mini-Zellen, 1,5 Volt, sind erforderlich)

Mango de pila ø 18 mm (se necesitan 2 pilas Mini de 1,5 V)

Poignée à piles ø 18 mm (2 piles Mini, 1,5 volts sont nécessaires)

Manico per pila ø 18 mm (2 pile Mini di 1,5 volt sono necessarie)

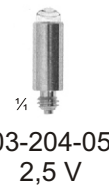

03-204-05  
2,5 V

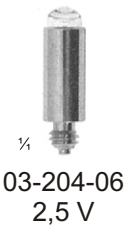

03-204-06  
2,5 V

**Halogen Lamp 2,5 V**  
 Halogenlampe 2,5 V  
 Lámpara halógeno 2,5 V  
 Lampe halogène 2,5 V





**GUEDEL-NEGUS**  
 03-278-00

Laryngoscope set, consisting of:

- 03-275-01 1 Laryngoscope blade 70 mm Fig,1
- 03-275-02 1 Laryngoscope blade 90 mm Fig,2
- 03-275-03 1 Laryngoscope blade 110 mm Fig,3
- 03-275-04 1 Laryngoscope blade 135 mm Fig,4
- 03-211-01 1 Battery handle, ø 30 mm (without batteries)
- 03-204-03 1 Case

Laryngoskopie-Besteck, bestehend aus:

- 03-275-01 1 Laryngoskopie-Spatel 70 mm Fig,1
- 03-275-02 1 Laryngoskopie-Spatel 90 mm Fig,2
- 03-275-03 1 Laryngoskopie-Spatel 110 mm Fig,3
- 03-275-04 1 Laryngoskopie-Spatel 135 mm Fig,4
- 03-211-01 1 Batteriegrieff ø 30 mm (ohne Batterien)
- 03-204-03 1 Etui

Juego para laringoscopia, compuesto de:

- 03-275-01 1 Espátula de laringoscopia 70 mm Fig,1
- 03-275-02 1 Espátula de laringoscopia 90 mm Fig,2
- 03-275-03 1 Espátula de laringoscopia 110 mm Fig,3
- 03-275-04 1 Espátula de laringoscopia 135 mm Fig,4
- 03-211-01 1 Mango de pila ø 30 mm (sin pilas)
- 03-204-03 1 Estuche

Trousse à laryngoscopie, composée de:

- 03-275-01 1 Spatule pour laryngoscope 70 mm Fig,1
- 03-275-02 1 Spatule pour laryngoscope 90 mm Fig,2
- 03-275-03 1 Spatule pour laryngoscope 110 mm Fig,3
- 03-275-04 1 Spatule pour laryngoscope 135 mm Fig,4
- 03-211-01 1 Poignée à piles ø 30 mm (sans piles)
- 03-204-03 1 Boîte

Set per laringoscopia, composto da:

- 03-275-01 1 Spatola per laringoscopia 70 mm Fig,1
- 03-275-02 1 Spatola per laringoscopia 90 mm Fig,2
- 03-275-03 1 Spatola per laringoscopia 110 mm Fig,3
- 03-275-04 1 Spatola per laringoscopia 135 mm Fig,4
- 03-211-01 1 Manico per pila ø 30 mm (senza pila)
- 03-204-03 1 astuccio

**GUEDEL-NEGUS**  
 03-277-00

Laryngoscope set, consisting of:

- 03-275-02 1 Laryngoscope blade 90 mm Fig,2
- 03-275-03 1 Laryngoscope blade 110 mm Fig,3
- 03-275-04 1 Laryngoscope blade 135 mm Fig,4
- 03-211-01 1 Battery handle, ø 30 mm (without batteries)
- 03-204-03 1 Case

Laryngoskopie-Besteck, bestehend aus:

- 03-275-02 1 Laryngoskopie-Spatel 90 mm Fig,2
- 03-275-03 1 Laryngoskopie-Spatel 110 mm Fig,3
- 03-275-04 1 Laryngoskopie-Spatel 135 mm Fig,4
- 03-211-01 1 Batteriegrieff ø 30 mm (ohne Batterien)
- 03-204-03 1 Etui

Juego para laringoscopia, compuesto de:

- 03-275-02 1 Espátula de laringoscopia 90 mm Fig,2
- 03-275-03 1 Espátula de laringoscopia 110 mm Fig,3
- 03-275-04 1 Espátula de laringoscopia 135 mm Fig,4
- 03-211-01 1 Mango de pila ø 30 mm (sin pilas)
- 03-204-03 1 Estuche

Trousse à laryngoscopie, composée de:

- 03-275-02 1 Spatule pour laryngoscope 90 mm Fig,2
- 03-275-03 1 Spatule pour laryngoscope 110 mm Fig,3
- 03-275-04 1 Spatule pour laryngoscope 135 mm Fig,4
- 03-211-01 1 Poignée à piles ø 30 mm (sans piles)
- 03-204-03 1 Boîte

Set per laringoscopia, composto da:

- 03-275-02 1 Spatola per laringoscopia 90 mm Fig,2
- 03-275-03 1 Spatola per laringoscopia 110 mm Fig,3
- 03-275-04 1 Spatola per laringoscopia 135 mm Fig,4
- 03-211-01 1 Manico per pila ø 30 mm (senza pila)
- 03-204-03 1 astuccio

