

ROCK GRIP

053

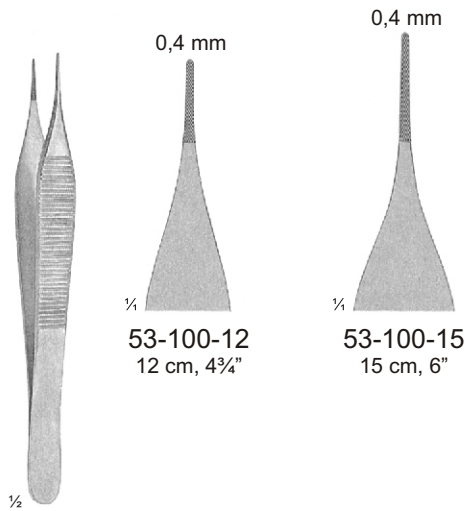

Forceps with tungsten carbide inserts
Pinzetten mit Hartmetalleinlagen
Pinzas con bocas de carburo tungsteno
Pinces avec mors en carbure tungstène
Pinze con morsi in carburo di tungsteno



**MICRO
ADSON**
53-100-12
53-100-15

0,4 mm
¼
53-100-12
12 cm, 4¾"

0,4 mm
¼
53-100-15
15 cm, 6"

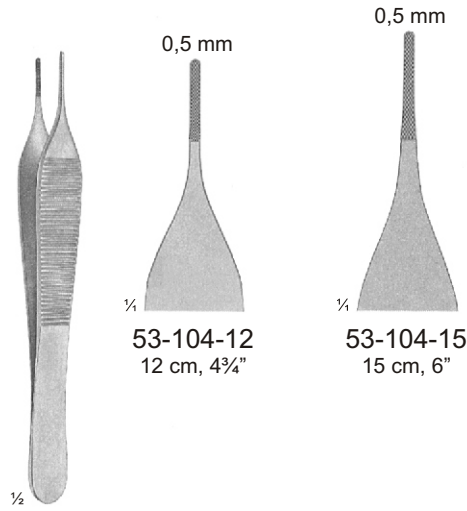

ADSON
53-104-12
53-104-15

0,5 mm
¼
53-104-12
12 cm, 4¾"

0,5 mm
¼
53-104-15
15 cm, 6"

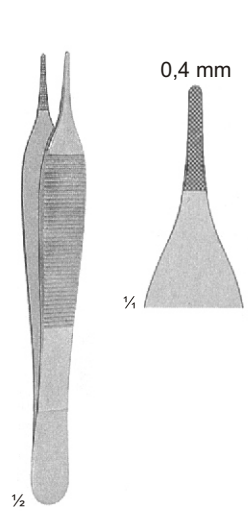

ADSON
53-108-12
12 cm, 4¾"

0,4 mm
¼

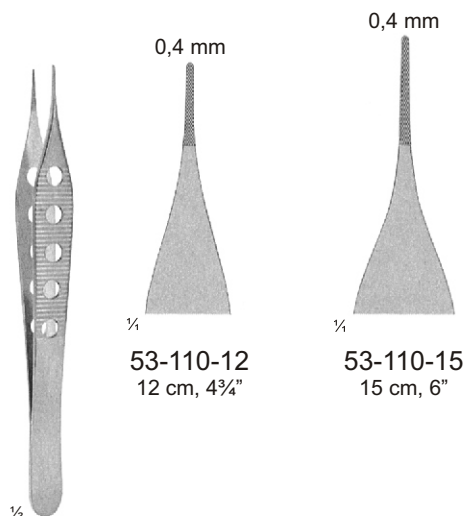

**MICRO
ADSON**
53-110-12
53-110-15

0,4 mm
¼
53-110-12
12 cm, 4¾"

0,4 mm
¼
53-110-15
15 cm, 6"

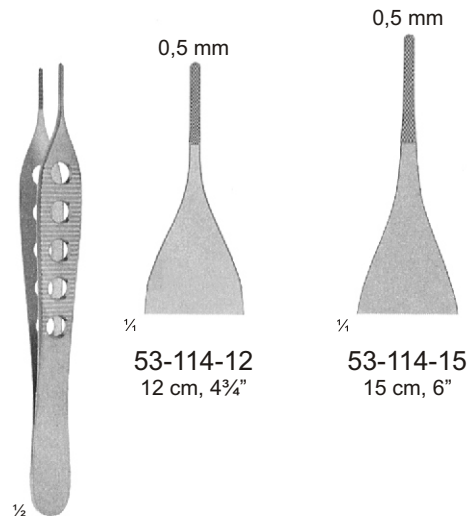

ADSON
53-114-12
53-114-15

0,5 mm
¼
53-114-12
12 cm, 4¾"

0,5 mm
¼
53-114-15
15 cm, 6"

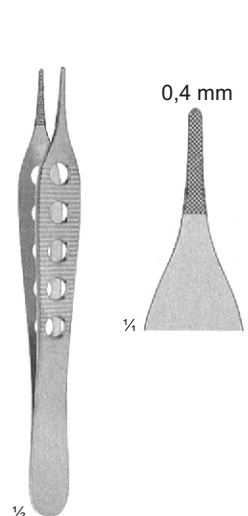

ADSON
53-118-12
12 cm, 4¾"

0,4 mm
¼

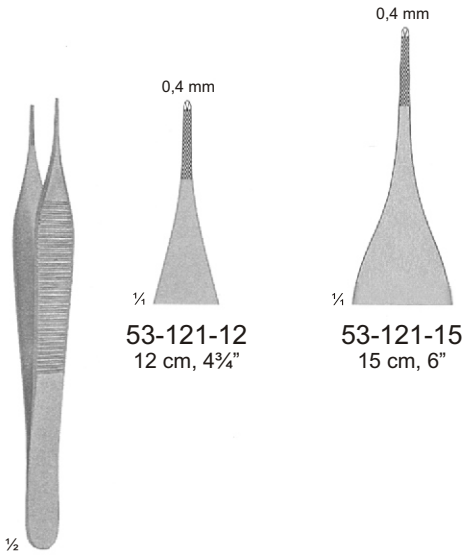

53-121-12
12 cm, 4³/₄"

53-121-15
15 cm, 6"

**MICRO
ADSON**
53-121-12
53-121-15

1x2 Teeth
1x2 Zähne
1x2 dientes
1x2 dents
1x2 denti

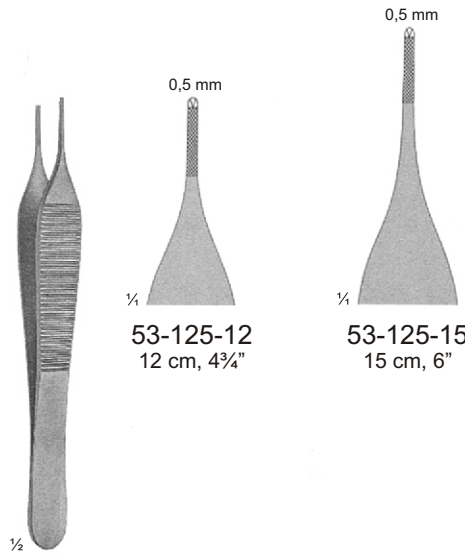

53-125-12
12 cm, 4³/₄"

53-125-15
15 cm, 6"

ADSON
53-125-12
53-125-15

1x2 Teeth
1x2 Zähne
1x2 dientes
1x2 dents
1x2 denti

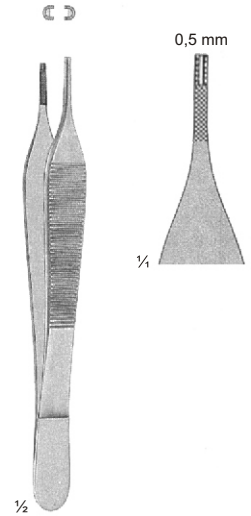

ADSON-BROWN
53-129-12
12 cm, 4³/₄"

3x4 Teeth
3x4 Zähne
3x4 dientes
3x4 dents
3x4 denti

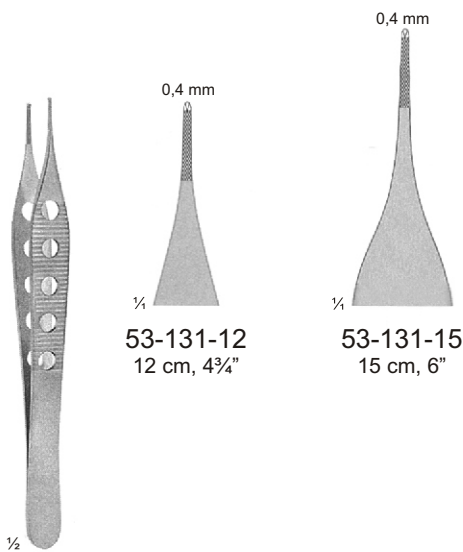

53-131-12
12 cm, 4³/₄"

53-131-15
15 cm, 6"

**MICRO
ADSON**
53-131-12
53-131-15

1x2 Teeth
1x2 Zähne
1x2 dientes
1x2 dents
1x2 denti

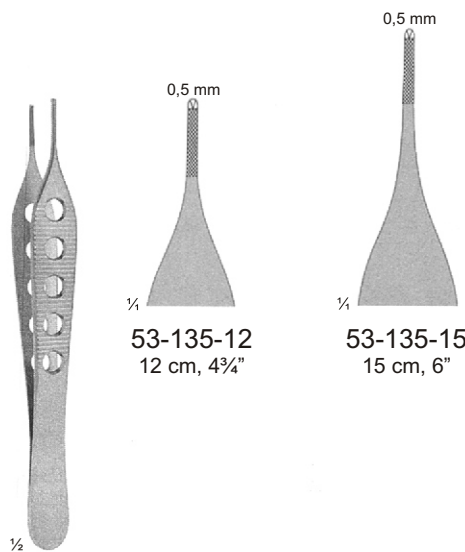

53-135-12
12 cm, 4³/₄"

53-135-15
15 cm, 6"

ADSON
53-135-12
53-135-15

1x2 Teeth
1x2 Zähne
1x2 dientes
1x2 dents
1x2 denti

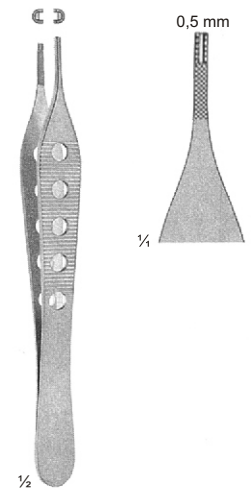

ADSON-BROWN
53-139-12
12 cm, 4³/₄"

3x4 Teeth
3x4 Zähne
3x4 dientes
3x4 dents
3x4 denti



Dissecting Forceps with tungsten carbide inserts
 Anatomische Pinzetten mit Hartmetalleinlagen
 Pizas de disección con bocas de carburo tungsteno
 Pincés à dissection avec mors en tungstène
 Pinze anatomiche per dissezione con morsi in carburo di tungsteno



ROCK GRIP 053

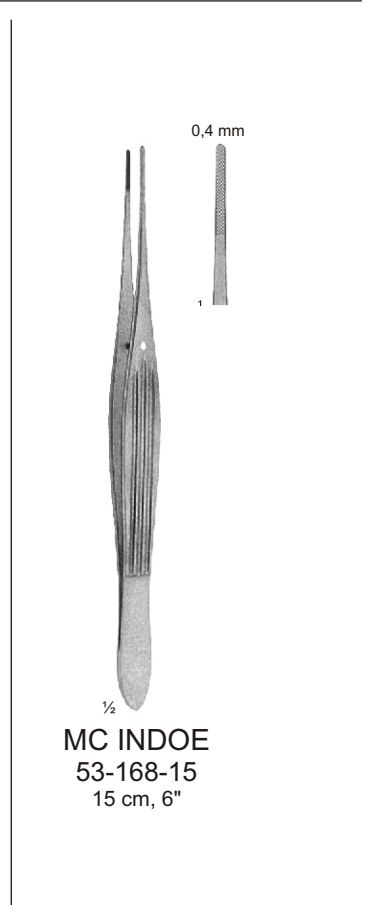
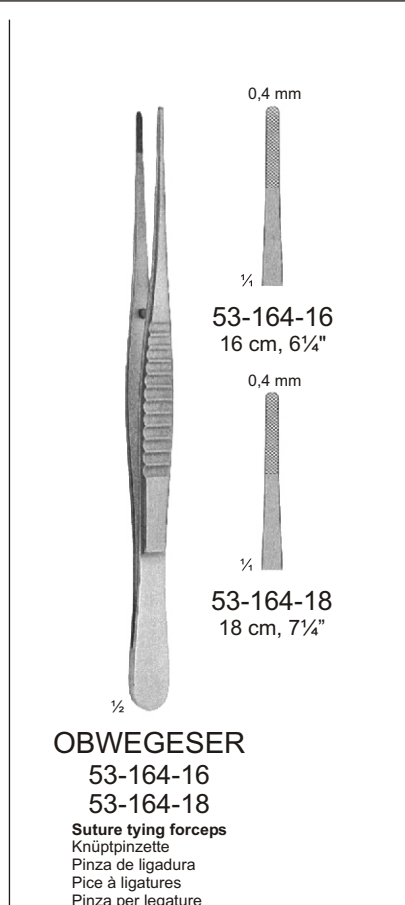
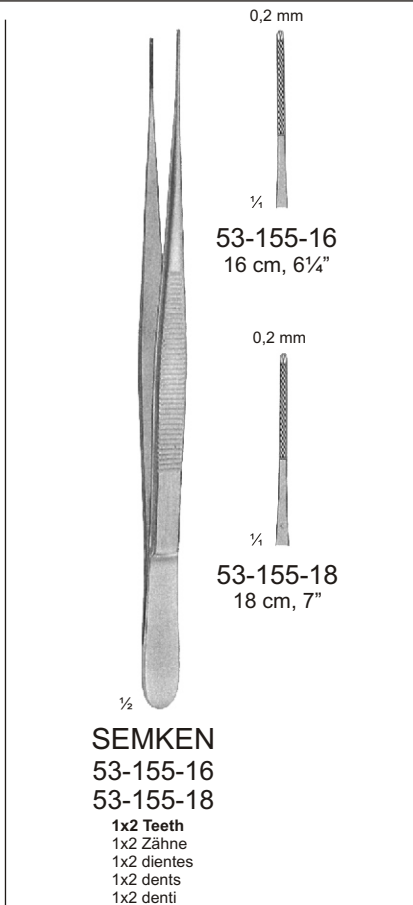
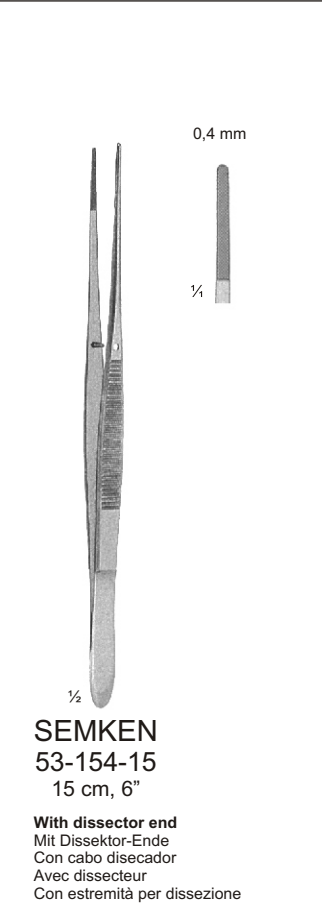
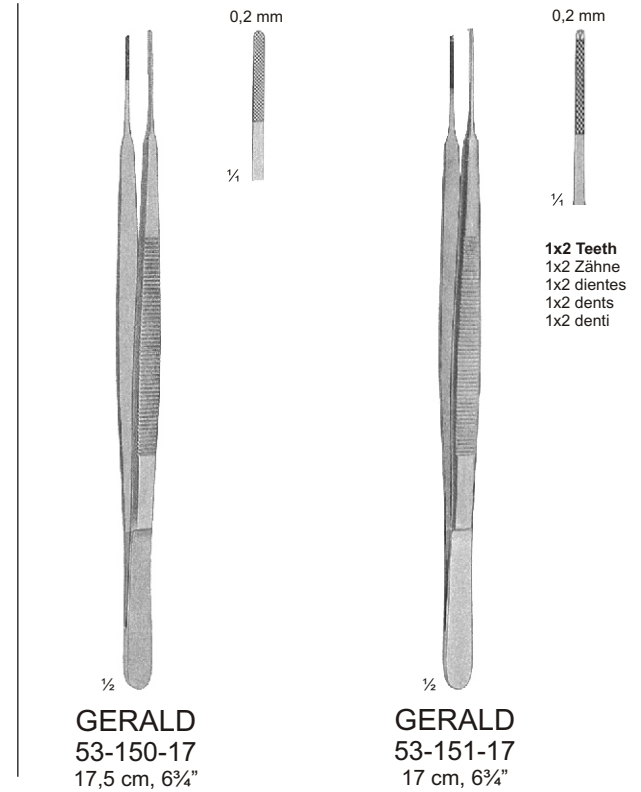
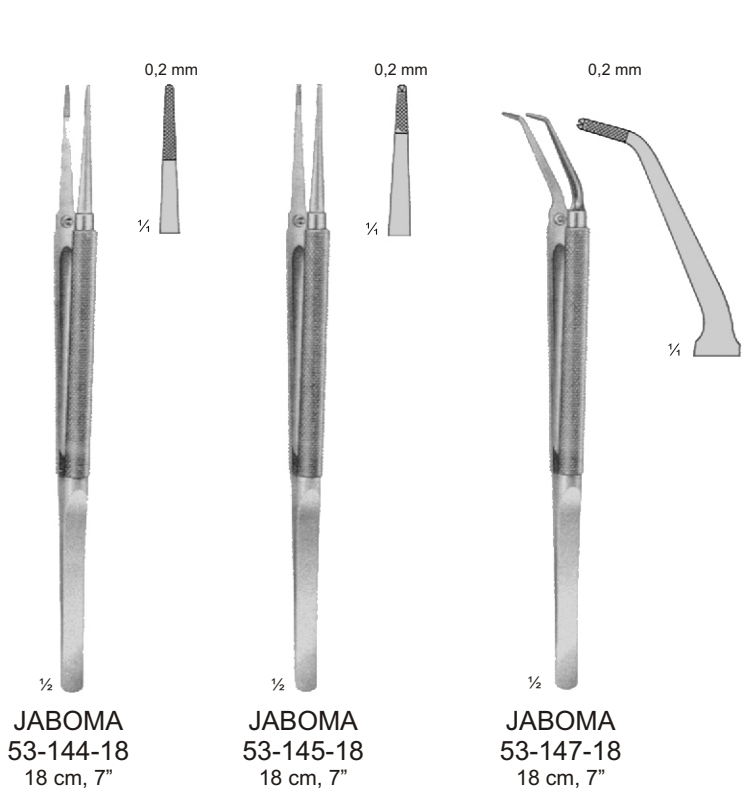

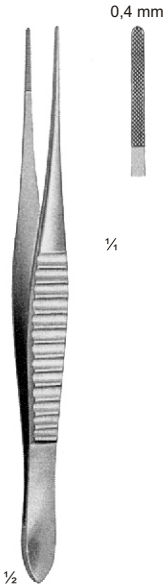

GILLIES
 53-200-15
 15 cm, 6"

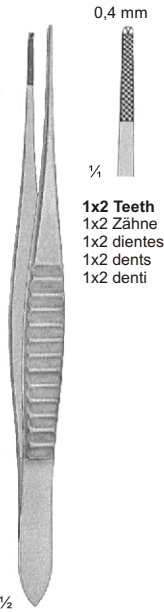

GILLIES
 53-201-15
 15 cm, 6"

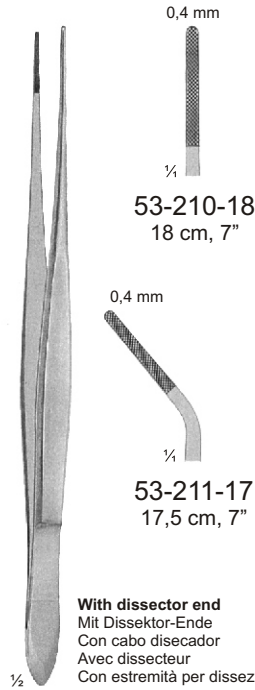

CUSHING
 53-210-17
 53-211-18

With dissector end
 Mit Dissektor-Ende
 Con cabo disecador
 Avec dissecteur
 Con estremità per dissezione

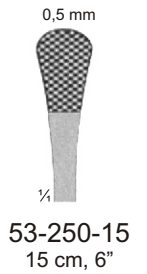
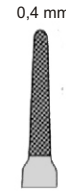

53-250-15
 15 cm, 6"



53-250-23
 23 cm, 9"



53-250-25
 25,5 cm, 10"

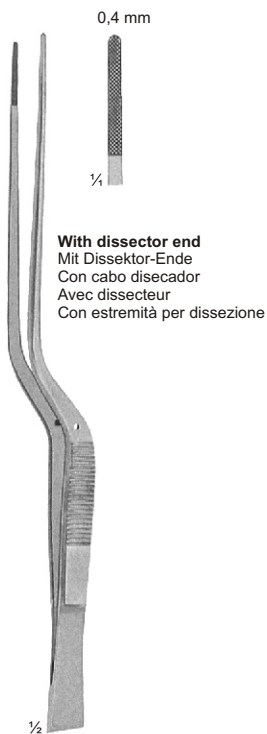

**TAYLOR
 CUSHING**
 53-220-18
 18 cm, 7"

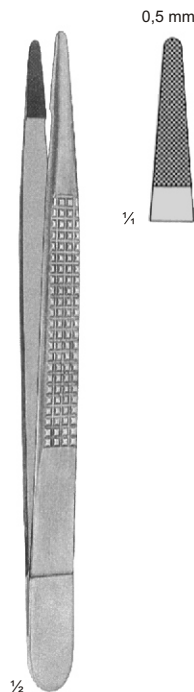

BONNEY
 53-228-17
 17 cm, 6³/₄"

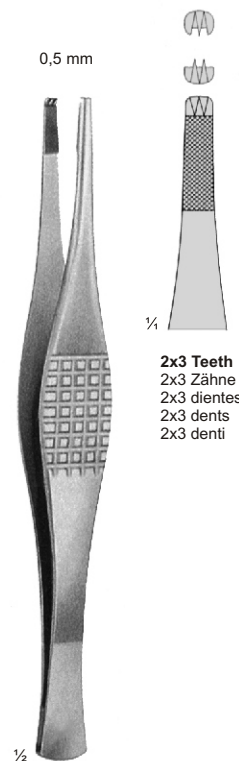

FERRIS-SMITH
 53-231-17
 17 cm, 6³/₄"



EVANS
 53-246-25
 25 cm, 10"

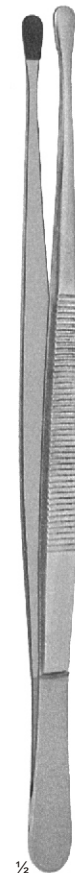

WANGENSTEEN
 53-250-15
 53-250-25



1/2
 53-180-13
 53-180-25

0,4 mm 1/4 53-180-13 13 cm, 5"	0,4 mm 1/4 53-180-14 14,5 cm, 5 1/2"	0,4 mm 1/4 53-180-16 16 cm, 6 1/4"
0,4 mm 1/4 53-180-18 18 cm, 7"	0,4 mm 1/4 53-180-20 20 cm, 8"	0,4 mm 1/4 53-180-25 25 cm, 10"

Standard patterns
 Standard modelle
 Modelos standard
 Modèles standard
 Modelli standard



1/2
 53-181-13
 53-181-25

0,4 mm 1/4 53-181-13 13 cm, 5"	0,4 mm 1/4 53-181-14 14,5 cm, 5 1/2"	0,4 mm 1/4 53-181-16 16 cm, 6 1/4"
0,4 mm 1/4 53-181-18 18 cm, 7"	0,4 mm 1/4 53-181-20 20 cm, 8"	0,4 mm 1/4 53-181-25 25 cm, 10"

Standard patterns
 Standard modelle
 Modelos standard
 Modèles standard
 Modelli standard

1x2 Teeth
 1x2 Zähne
 1x2 Dientes
 1x2 Dents
 1x2 Denti

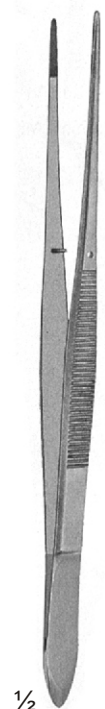

1/2

0,4 mm 1/4 53-190-13 13 cm, 5"	0,4 mm 1/4 53-190-16 16 cm, 6 1/4"	0,4 mm 1/4 53-190-18 18 cm, 7"
0,4 mm 1/4 53-190-20 20 cm, 8"	0,4 mm 1/4 53-190-23 23 cm, 9"	0,4 mm 1/4 53-190-25 25 cm, 10"

POTTS-SMITH
 53-190-13
 53-190-25



1/2



1,5 mm 1/4 53-191-15 15 cm, 6"	2 mm 1/4 53-193-15 15 cm, 6"
53-191-20 20 cm, 8"	53-193-20 20 cm, 8"
53-191-24 24 cm, 9 1/2"	53-193-24 24 cm, 9 1/2"
2,7 mm 53-195-16 16 cm, 6 1/4"	3,5 mm 53-197-16 16 cm, 6 1/4"
53-195-20 20 cm, 8"	53-197-20 20 cm, 8"
53-195-24 24 cm, 9 1/2"	53-197-24 24 cm, 9 1/2"

DE BAKHEY
 53-191-15
 53-197-24