

09



Forceps
Pinzetten
Pinzas
Pinces
Pinze



Fig. 01

09-100-01
12 cm, 4 $\frac{3}{4}$ "

Fine points
 Fine spitzen
 Puntas finas
 Pointes fines
 Punta fini



Fig. 02

09-100-02
12 cm, 4 $\frac{3}{4}$ "



Fig. 03

09-100-03
12 cm, 4 $\frac{3}{4}$ "

Extra fine points
 Extra fine spitzen
 Puntas extra finas
 Pointes erès fines
 Punta extra fini



Fig. 3c

09-100-3C
11 cm, 4 $\frac{3}{8}$ "

Extra fine points
 Extra fine spitzen
 Puntas extra finas
 Pointes erès fines
 Punta extra fini



Fig. 3x

09-100-3X
12 cm, 4 $\frac{3}{4}$ "



Fig. 04

09-100-04
11 cm, 4 $\frac{3}{8}$ "

Extra fine points
 Extra fine spitzen
 Puntas extra finas
 Pointes erès fines
 Punta extra fini



Fig. 05

09-100-05
11 cm, 4 $\frac{3}{8}$ "

Super fine points
 Superfeine spitzen
 Puntas super finas
 Pointes superfines
 Punta super fini



Fig. 5s

09-100-5S
11 cm, 4 $\frac{3}{8}$ "

Super fine points
 Superfeine spitzen
 Puntas super finas
 Pointes superfines
 Punta super fini



Fig. 5x

09-100-5X
11 cm, 4 $\frac{3}{8}$ "



Fig. 06

09-100-06
11 cm, 4 $\frac{3}{8}$ "



Fig. 07

09-100-07
11 cm, 4 $\frac{3}{8}$ "

Fine points
 Fine spitzen
 Puntas finas
 Pointes fines
 Punta fini



Fig. 7x

09-100-7X
11 cm, 4 $\frac{3}{8}$ "



Fig. 101-11

09-101-11
11,5 cm, 4 $\frac{1}{2}$ "

1x2 Teeth
 1x2 Zähne
 1x2 Dientes
 1x2 Dents
 1x2 Denti



Fig. 106-13

09-106-13
13,5 cm, 5 $\frac{1}{4}$ "

1x2 Teeth
 1x2 Zähne
 1x2 Dientes
 1x2 Dents
 1x2 Denti



Fig. 108-13

09-108-13
13,5 cm, 5 $\frac{1}{4}$ "

1x2 Teeth
 1x2 Zähne
 1x2 Dientes
 1x2 Dents
 1x2 Denti



Fig. 110-09

09-110-09
9,5 cm, 3 $\frac{3}{4}$ "

1x2 Teeth
 1x2 Zähne
 1x2 Dientes
 1x2 Dents
 1x2 Denti

Micro Suture Tying Forceps

Mikro-Knüpfpinzetten
 Micro-pinzas de ligadura
 Micro-pinces à ligatures
 Micro-pinze per legature



09-120-10
10 cm, 4"

09-121-10
10 cm, 4"

09-120-10
09-121-10

09-124-12
12 cm, 4 3/4"

09-124-12

09-126-13
13,5 cm, 5 1/4"

09-127-13
13,5 cm, 5 1/4"

09-126-13
09-127-13

09-130-18
18,5 cm, 7 1/4"

09-130-18

09-132-01
15,5 cm, 6"

09-132-02
15,5 cm, 6"

LARAZ
09-132-01
09-132-02

09-140-12
12 cm, 4 3/4"

09-141-12
12 cm, 4 3/4"

09-140-12
09-141-12

09-142-15
15 cm, 6"

09-143-15
15 cm, 6"

09-142-15
09-143-15

09-144-18
18 cm, 7"

09-145-18
18 cm, 7"

09-144-18
09-145-18

Micro, Tumor and Tissue Grasping Forceps, baynet-shaped

Mikro, Tumor-und Gewebefaßpinzetten, bajoettförmig

Micro, Pinzas de agarre para tejido y tumor, en forma bayoneta

Micro, Pinces en forme de baïonnette pour saisir tumeurs et tissus

Micro, Pinze per afferare tessuti e tumori, a baionetta

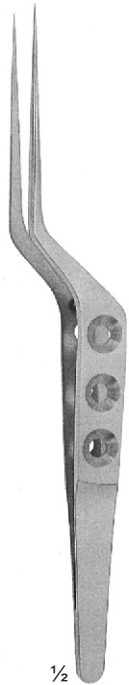

YASARGIL
09-150-18
09-152-24

With smooth jaws
Mit glatten maulteilen
Con bocas lisas
Avec mors lisses
Con morsi lisci

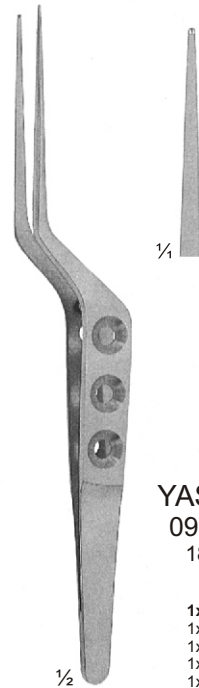
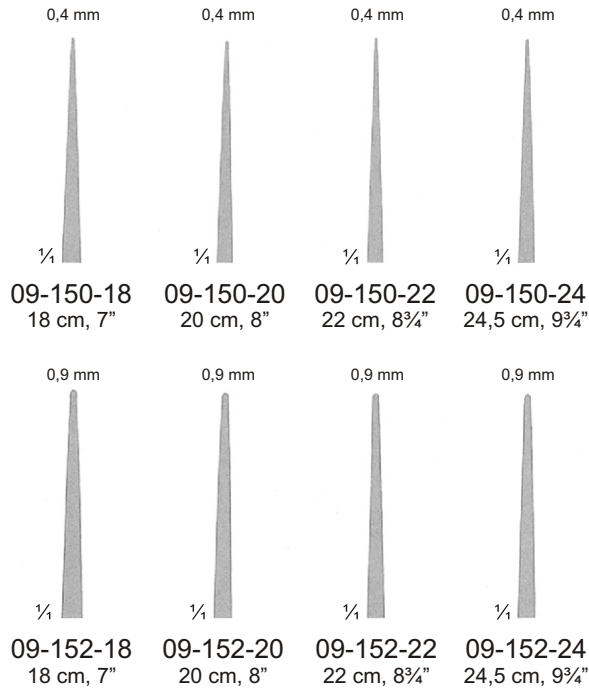

YASARGIL
09-156-18
18 cm, 7"

1x2 Teeth
1x2 Zähne
1x2 Dientes
1x2 Dents
1x2 Denti

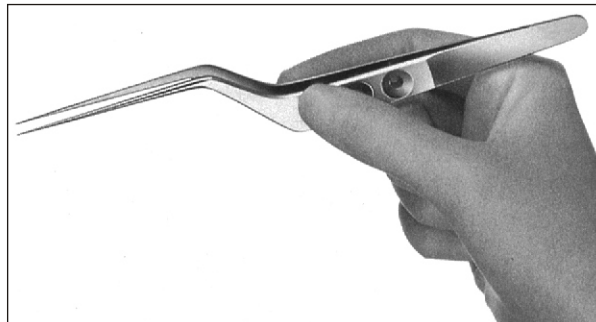

YASARGIL
09-162-01
09-168-03

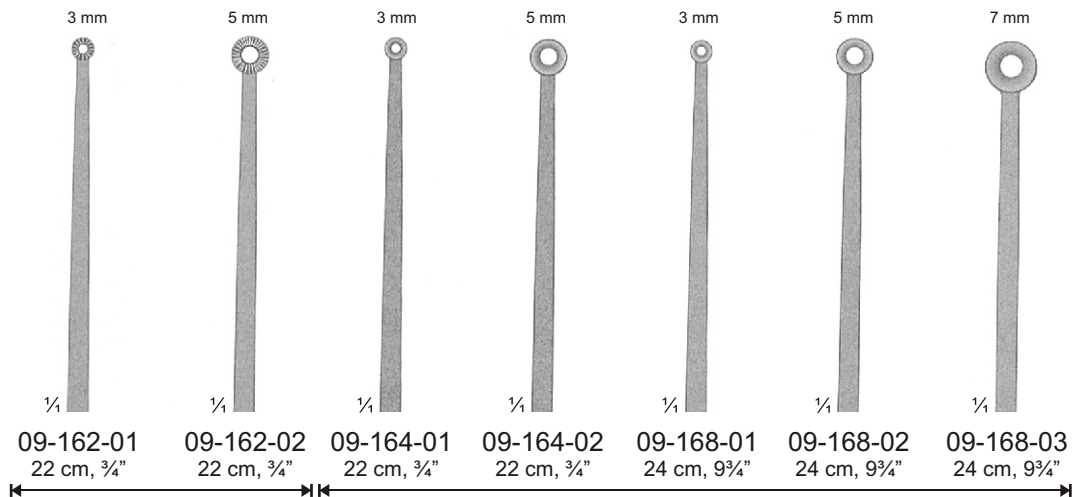

Flat jaws, serrated
Maul flach, gezahnt
Boca plana, dentada
Mors plats, Dentelés
Morsi piatti, dentati

Jaws spoon-shaped
Maul löffelförmig
Boca forma cuchara
Mors en forme de cuillère
Morsi a forma di cucchiaio

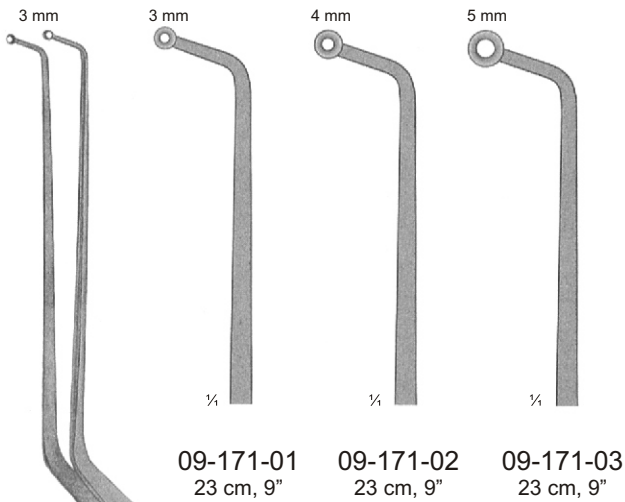

Jaws spoon-shaped
 Maul löffelförmig
 Boca forma cuchara
 Mors en forme de cuillère
 Morsi a forma di cucchiaio

½
SAMII
 09-171-01
 09-171-03

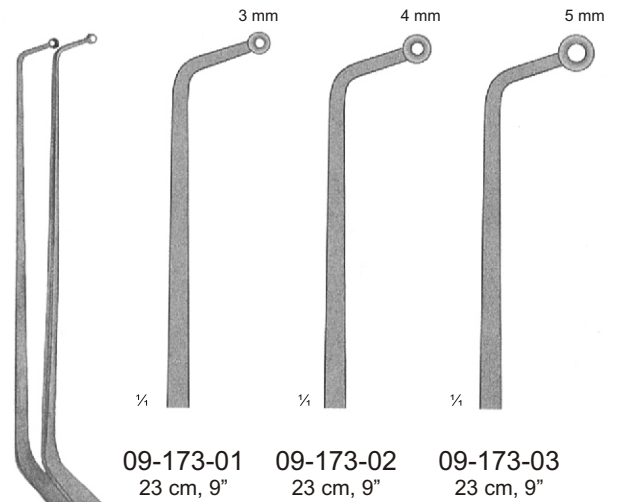

Jaws spoon-shaped
 Maul löffelförmig
 Boca forma cuchara
 Mors en forme de cuillère
 Morsi a forma di cucchiaio

½
SAMII
 09-173-01
 09-173-03

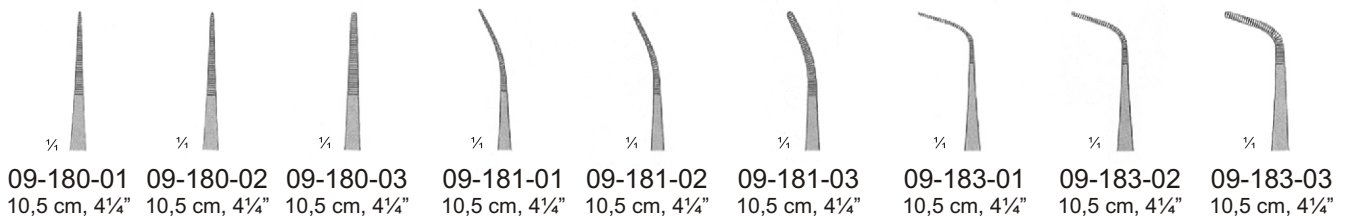

09-180-01
 09-183-03

Delicate Dissecting Forceps
 Feine anatomische pinzetten
 Pinzas finas de disección
 Pincen fines pour dissection
 Pinze anatomiche per dissezione, fini

Delicate Dissecting Forceps

Feine anatomische pinzetten
 Pinzas finas de disección
 Pincas fines pour dissection
 Pinze anatomiche per dissezione, fini

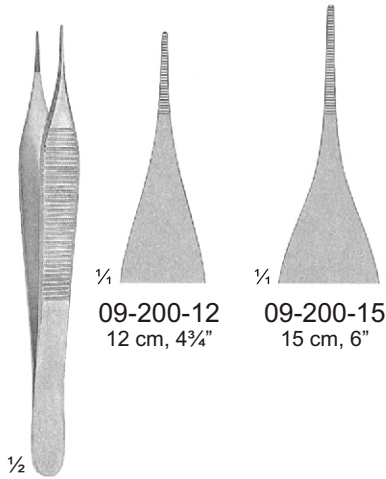

¼

09-200-12
12 cm, 4¾"

¼

09-200-15
15 cm, 6"

½

**MICRO
ADSON**
09-200-12
09-200-15

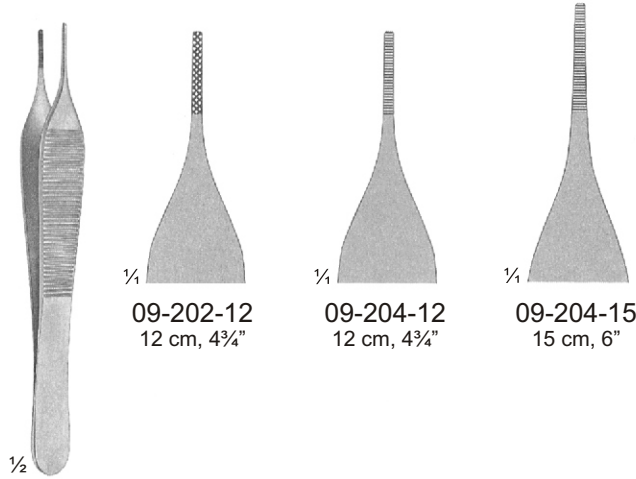

¼

09-202-12
12 cm, 4¾"

¼

09-204-12
12 cm, 4¾"

¼

09-204-15
15 cm, 6"

½

MINI ADSON
09-202-12
09-204-15

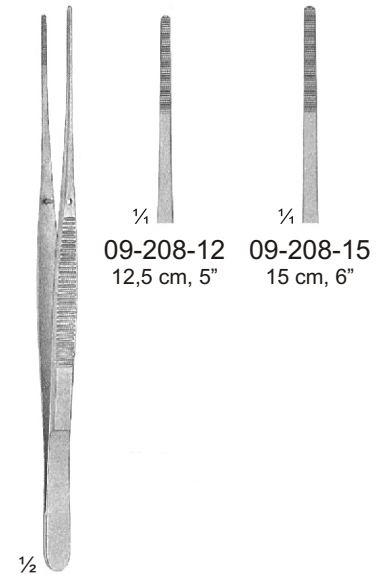

¼

09-208-12
12,5 cm, 5"

¼

09-208-15
15 cm, 6"

½

SEMKEN
09-208-12
09-208-15

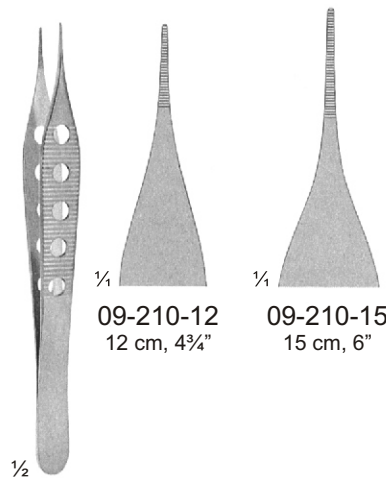

¼

09-210-12
12 cm, 4¾"

¼

09-210-15
15 cm, 6"

½

**MICRO
ADSON**
09-210-12
09-210-15

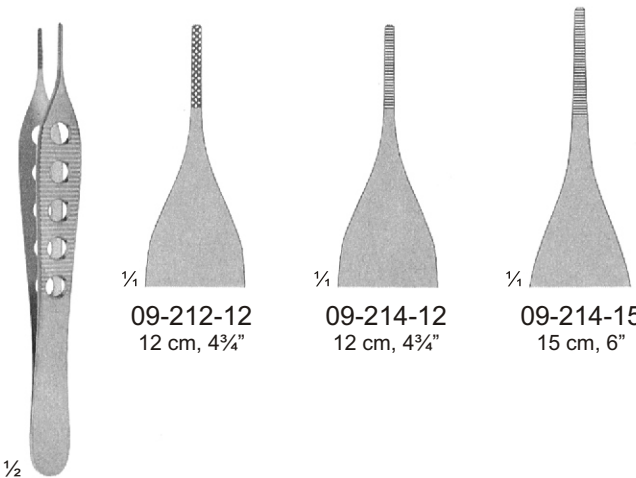

¼

09-212-12
12 cm, 4¾"

¼

09-214-12
12 cm, 4¾"

¼

09-214-15
15 cm, 6"

½

MINI ADSON
09-212-12
09-214-15

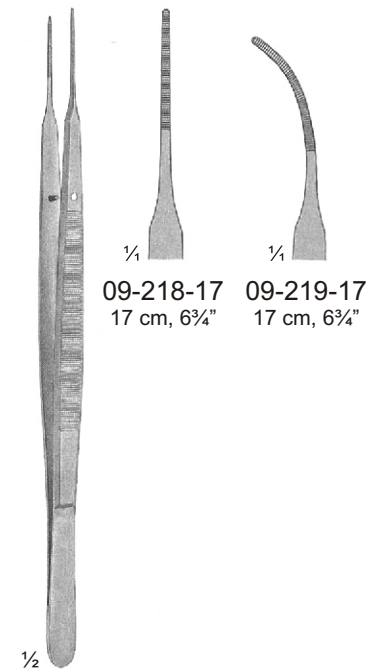

¼

09-218-17
17 cm, 6¾"

¼

09-219-17
17 cm, 6¾"

½

GERALD
09-218-17
09-219-17

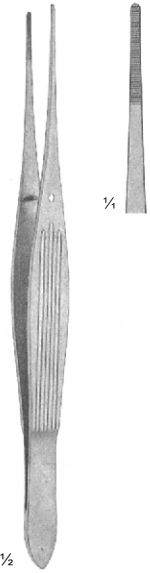

MC INDOE
 09-224-15
 15 cm, 6"



09-228-17
 17,5 cm, 7"

With dissector end
 Mit dissektor-ende
 Con cabo disecador
 Avec talon dissecteur
 Con dissetto

TAYLOR
 09-228-17
 09-229-17



09-229-17
 17,5 cm, 7"

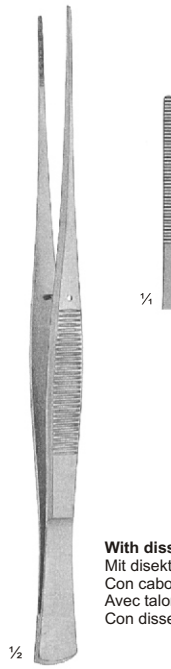

TAYLOR-CUSHING
 09-232-17
 17,5 cm, 7"

With dissector end
 Mit dissektor-ende
 Con cabo disecador
 Avec talon dissecteur
 Con dissetto



POTTS-SMITH
 09-236-18
 09-236-30



09-236-18
 18 cm, 7"



09-236-21
 21 cm, 8 1/4"



09-236-25
 25 cm, 10"

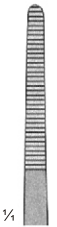

09-236-30
 30 cm, 12"



WAUGH
 09-240-20
 20 cm, 8"

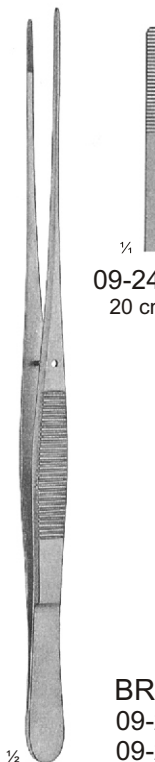

09-244-20
 20 cm, 8"

BROPHY
 09-244-20
 09-245-20



09-245-20
 20 cm, 8"

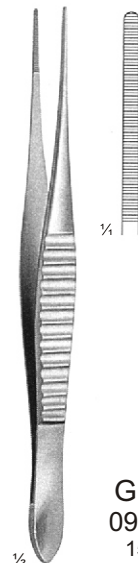

GILLIES
 09-250-15
 15 cm, 6"



MOD-USA
 09-252-13
 09-252-14



09-252-13
 13 cm, 5"



09-252-14
 14,5 cm, 5 1/2"

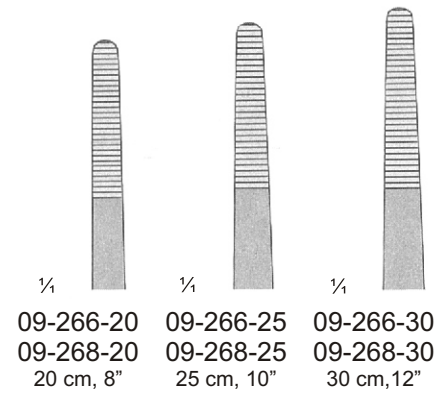
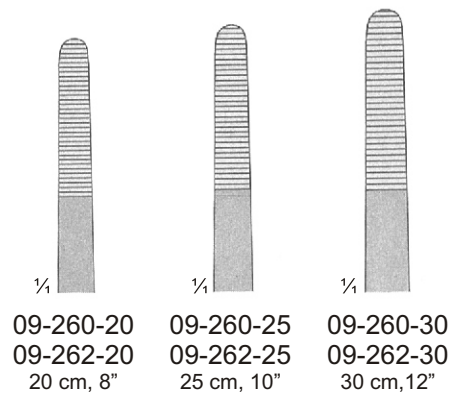
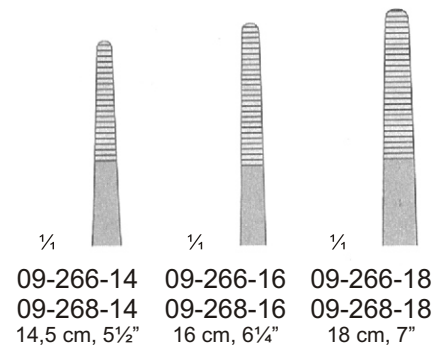
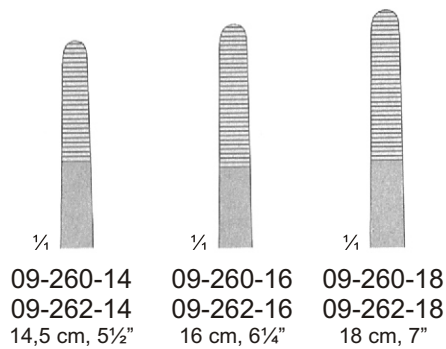
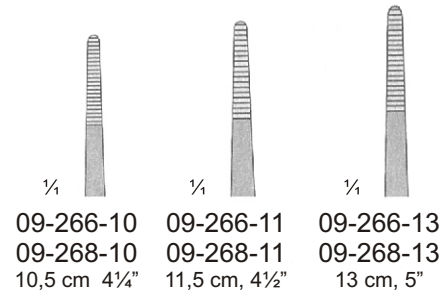
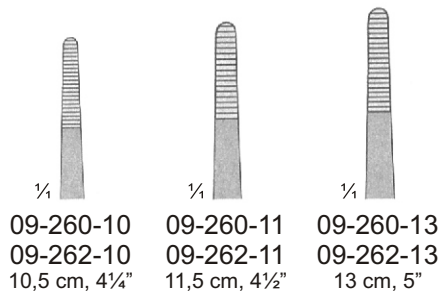

Standard patterns
 Standard modelle
 Modelos standard
 Modèles standard
 Modelli standard

Narrow Patterns
 Schmale Modelle
 Modelos estrechos
 Modèles étroits
 Modelli stretti



09-260-10
 09-260-30

MOD-USA
 09-262-10
 09-262-30

09-266-10
 09-266-30

MOD-USA
 09-268-10
 09-268-30

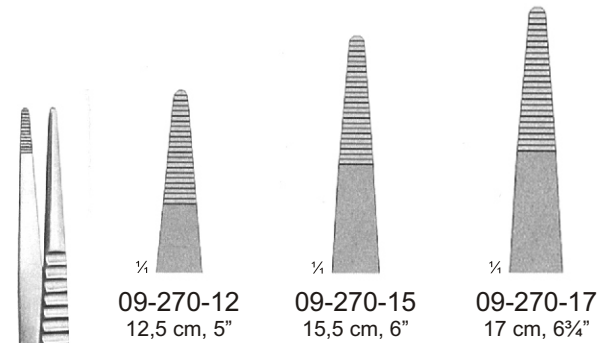

09-270-12
12,5 cm, 5"

09-270-15
15,5 cm, 6"

09-270-17
17 cm, 6¾"

English patterns
 Englische Modelle
 Modelos Ingleses
 Modèles anglais
 Modelli inglese

½
 09-270-12
 09-270-17

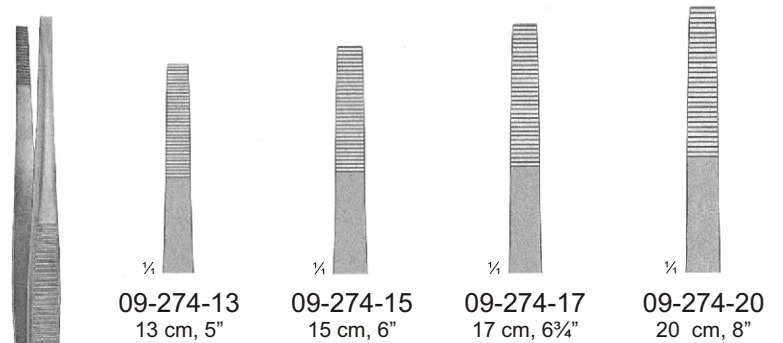

09-274-13
13 cm, 5"

09-274-15
15 cm, 6"

09-274-17
17 cm, 6¾"

09-274-20
20 cm, 8"

Swedish patterns
 Schwedische Modelle
 Modelos suecos
 Modèles suédois
 Modelli svedese

½
 09-274-13
 09-274-20

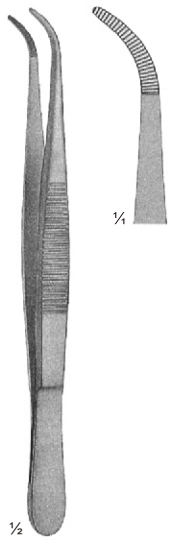

09-277-14
14 cm, 5½"

Narrow Patterns
 Schmale Modelle
 Modelos estrechos
 modèls étroits
 modelli stretti

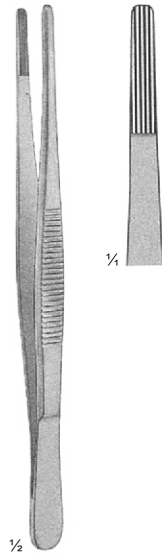

OCHSNER
 09-280-14
 14,5 cm, 5¾"

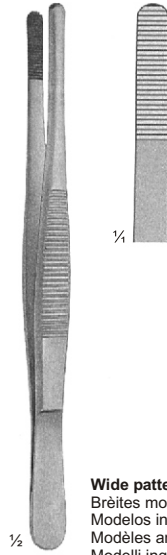

09-284-14
14,5 cm, 5¾"

Wide patterns
 Breites Modelle
 Modelos ingleses
 Modèles anglais
 Modelli inglese

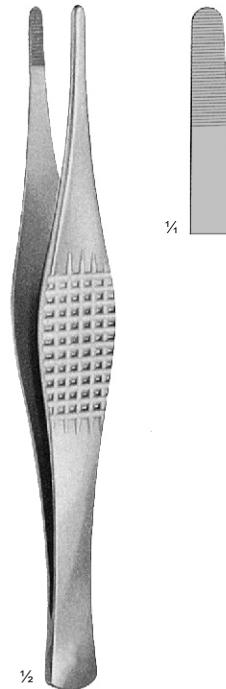

ARMSEY
 09-288-18
 18 cm, 7"

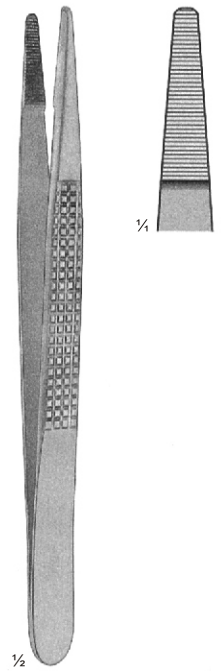

BONNEY
 09-290-17
 17 cm, 6¾"

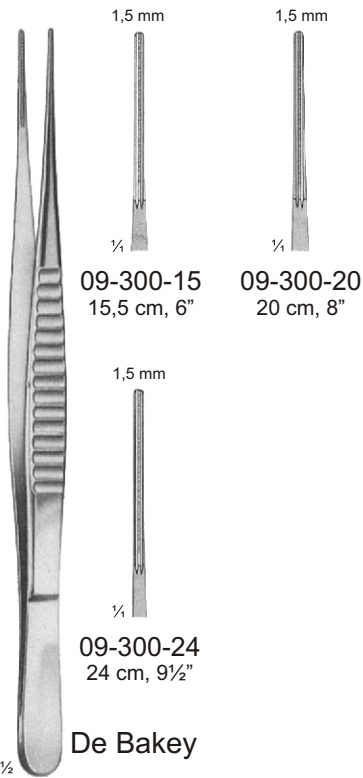

09-300-15
 09-300-24

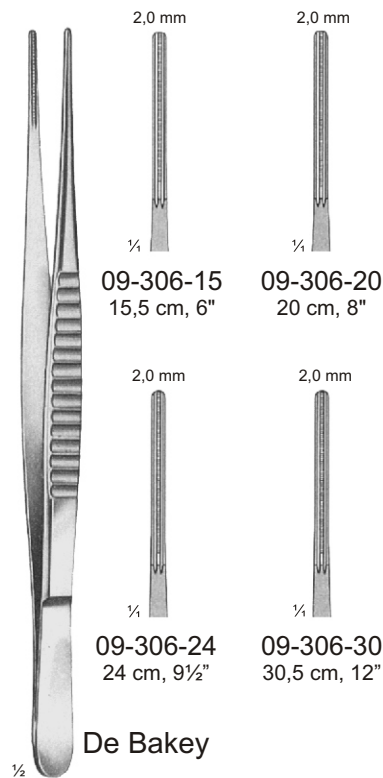

09-306-15
 09-306-30

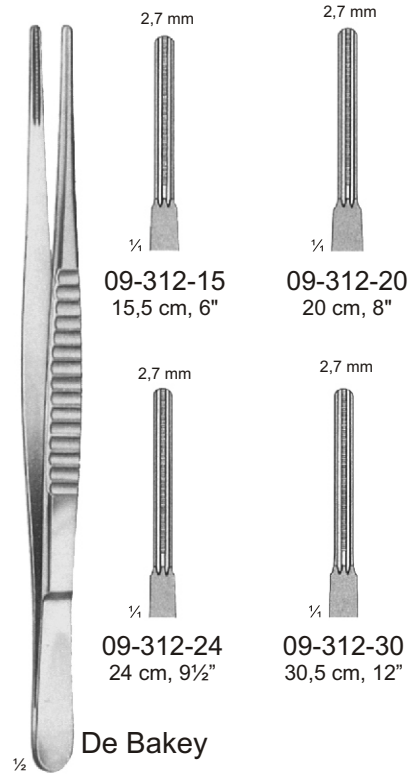

09-312-15
 09-312-30



09-316-16 16 cm, 6¼"
 09-316-20 20 cm, 8"

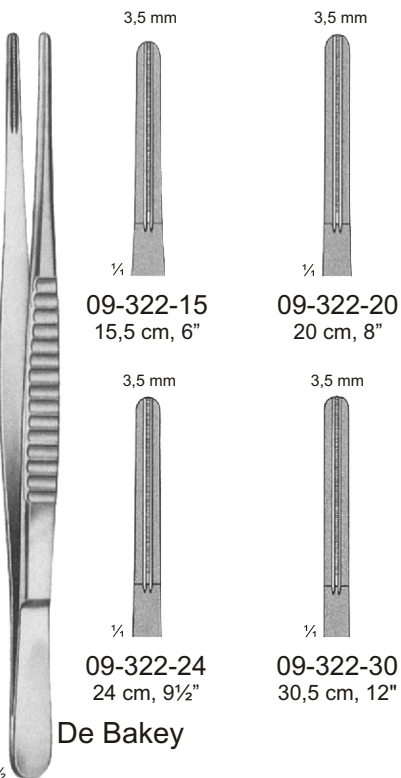

09-322-15
 09-322-30

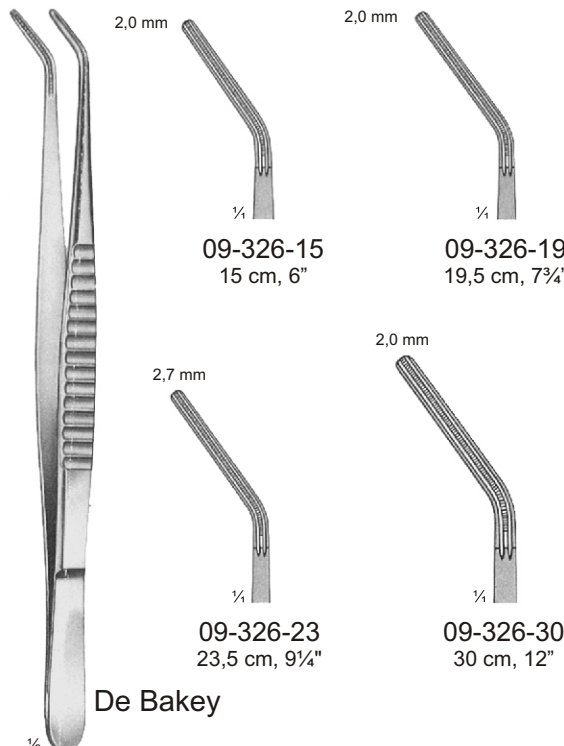

09-326-15
 09-326-30

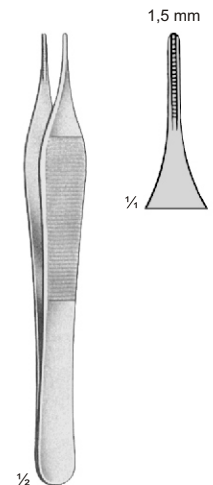

ADSON
 09-330-12 12 cm, 4¾"
 09-330-15 15 cm, 6"



Ear and Nasal Dressing Forceps, bayonet-shaped

Ohr-und Nasenpinzetten, bajonettförmig

Pinzas auriculares y nasales, en forma bayoneta

Pinces auriculaires et nasales, en forme de baïonnette

Pinze auricolari e nasali, a baionetta



09



LUCAE
09-340-14
14 cm, 5½"



JANSEN
09-342-16
16 cm, 6¼"
09-342-20
20 cm, 8"



GRUENWALD
09-348-20
20 cm, 8"



**TAYLOR
CUSHING**
09-350-18
18 cm, 7"

With dissector end
Mit dissektor-ende
Con cabo disecador
Avec talon dissecteur
Con dissettore

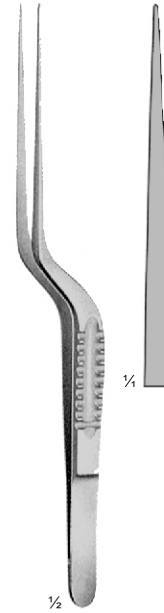

09-356-16
16 cm, 6¼"

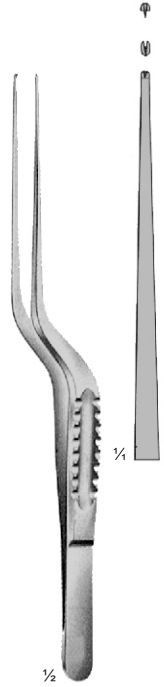

09-357-16
16 cm, 6¼"

1x2 Teeth
1x2 Zähne
1x2 Dientes
1x2 Dents
1x2 Dentii

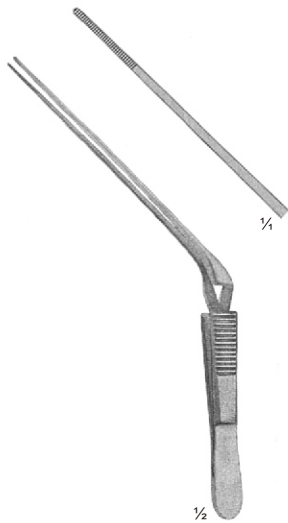

**TROELTSCH
(WILDE)**
09-362-13
13 cm, 5"

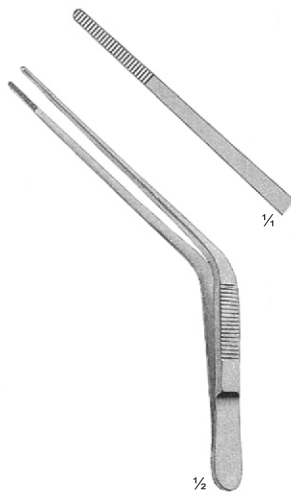

**TROELTSCH
(WILDE)**
09-366-11
11 cm, 4.5"
09-366-12
12 cm, 4¾"

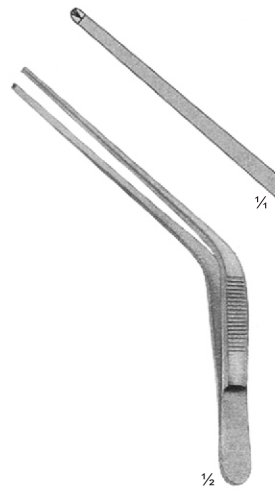

TROELTSCH
09-367-15
15 cm, 6"

1x2 Teeth
1x2 Zähne
1x2 Dientes
1x2 Dents
1x2 Dentii

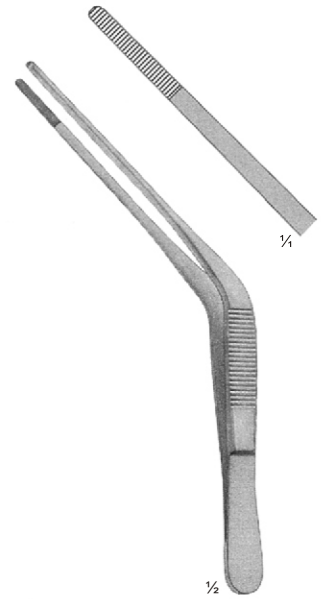

TROELTSCH
09-370-18
18 cm, 7"

1x2 Teeth
1x2 Zähne
1x2 Dientes
1x2 Dents
1x2 Dentii

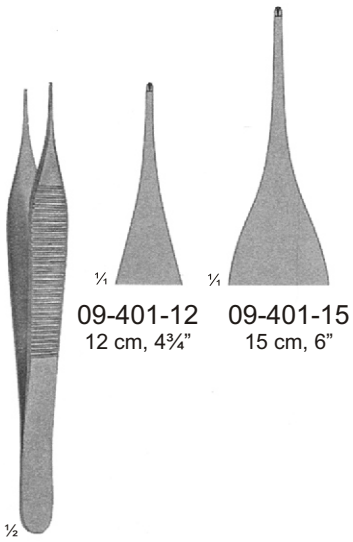

**MICRO
ADSON**
 09-401-12
 09-401-15

1x2 Teeth
 1x2 Zähne
 1x2 Dientes
 1x2 Dents
 1x2 Denti

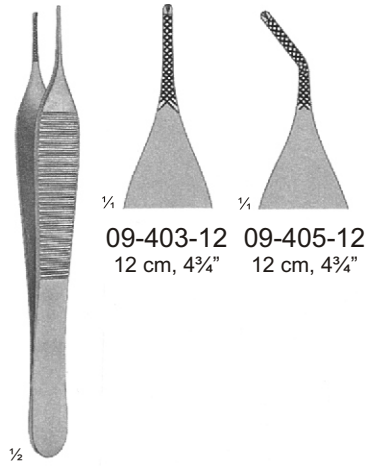

MINI ADSON
 09-403-12
 09-405-12

1x2 Teeth
 1x2 Zähne
 1x2 Dientes
 1x2 Dents
 1x2 Denti

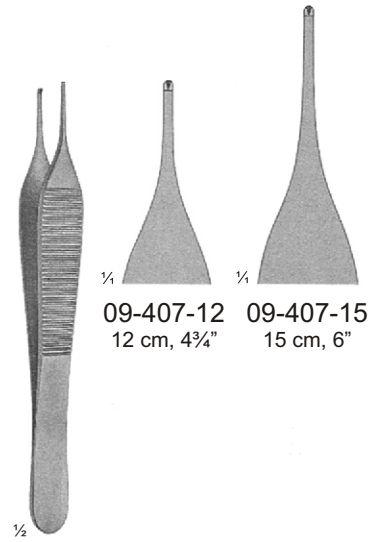

ADSON
 09-407-12
 09-407-15

1x2 Teeth
 1x2 Zähne
 1x2 Dientes
 1x2 Dents
 1x2 Denti

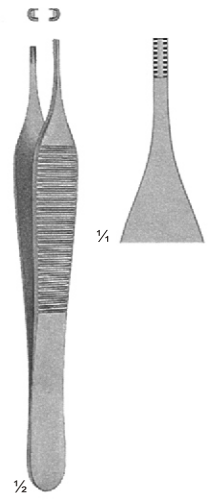

**ADSON
BROWN**
 09-409-12
 12 cm, 4 3/4"

9x9 Teeth
 9x9 Zähne
 9x9 Dientes
 9x9 Dents
 9x9 Denti

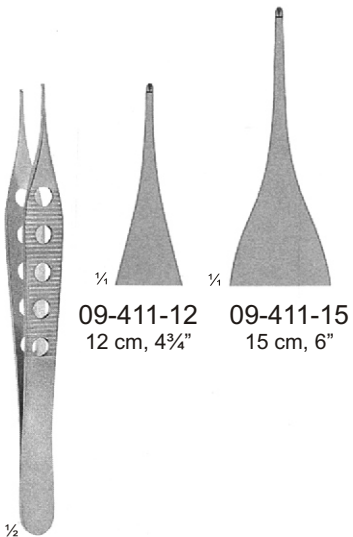

**MICRO
ADSON**
 09-411-12
 09-411-15

1x2 Teeth
 1x2 Zähne
 1x2 Dientes
 1x2 Dents
 1x2 Denti

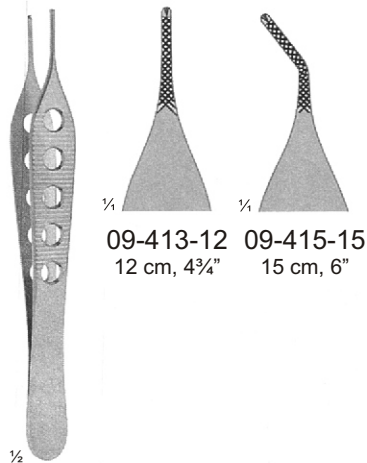

ADSON
 09-413-12
 09-415-15

1x2 Teeth
 1x2 Zähne
 1x2 Dientes
 1x2 Dents
 1x2 Denti

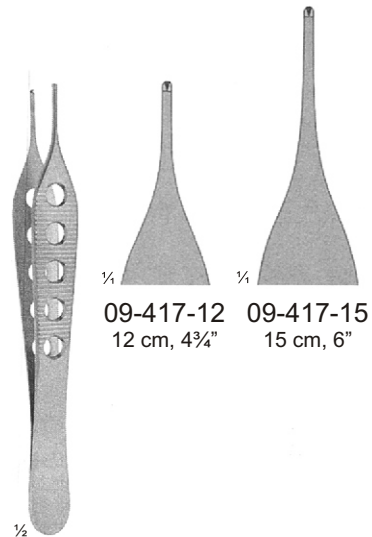

ADSON
 09-417-12
 09-417-15

1x2 Teeth
 1x2 Zähne
 1x2 Dientes
 1x2 Dents
 1x2 Denti

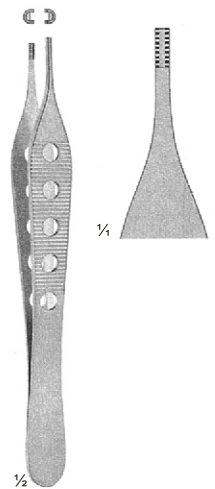

**ADSON
BROWN**
 09-419-12
 12 cm, 4 3/4"

9x9 Teeth
 9x9 Zähne
 9x9 Dientes
 9x9 Dents
 9x9 Denti



09-426-12
12,5 cm, 5"

¼



09-426-15
15 cm, 6"

¼

SEMKEN
09-426-12
09-426-15

1x2 Teeth
1x2 Zähne
1x2 Dientes
1x2 Dents
1x2 Denti



¼



CUSHING
09-433-17
17 cm, 6¾"

1x2 Teeth
1x2 Zähne
1x2 Dientes
1x2 Dents
1x2 Denti



¼



**TAYLOR
CUSHING**
09-435-17
17,5 cm, 7"

1x2 Teeth
1x2 Zähne
1x2 Dientes
1x2 Dents
1x2 Denti



½

09-437-18
18 cm, 7"

¼



09-437-21
21 cm, 8¼"

¼



09-437-25
25 cm, 10"

¼



09-437-30
30,5 cm, 12"

¼



POTTS-SMITH
09-437-18
09-437-30

1x2 Teeth
1x2 Zähne
1x2 Dientes
1x2 Dents
1x2 Denti



½

¼



WAUGH
09-439-20
20,5 cm, 8"

1x2 Teeth
1x2 Zähne
1x2 Dientes
1x2 Dents
1x2 Denti

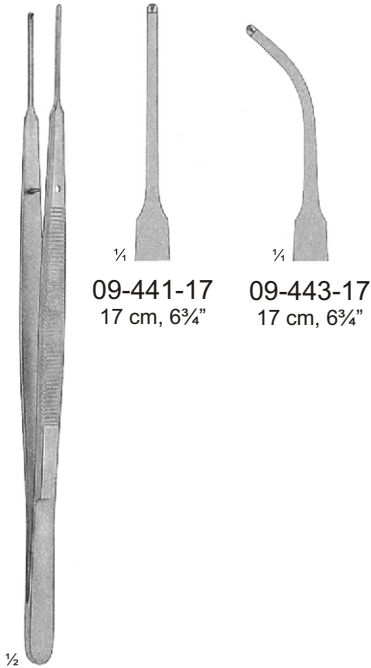

09-441-17
17 cm, 6¾"

09-443-17
17 cm, 6¾"

GERALD
09-441-17
09-443-17

1x2 Teeth
1x2 Zähne
1x2 Dientes
1x2 Dents
1x2 Denti

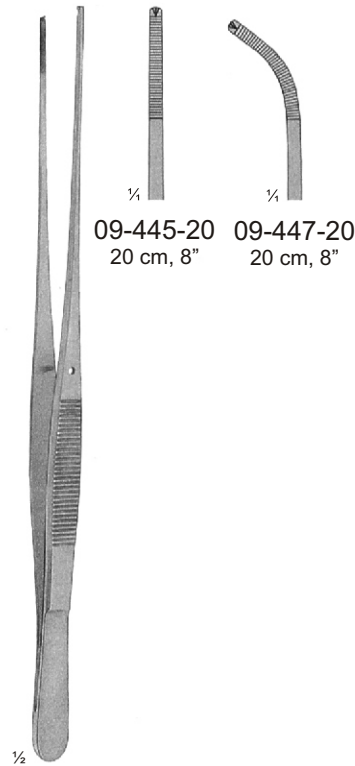

09-445-20
20 cm, 8"

09-447-20
20 cm, 8"

BROPHY
09-445-20
09-447-20

1x2 Teeth
1x2 Zähne
1x2 Dientes
1x2 Dents
1x2 Denti



GILLIES
09-449-15
15 cm, 6"

1x2 Teeth
1x2 Zähne
1x2 Dientes
1x2 Dents
1x2 Denti

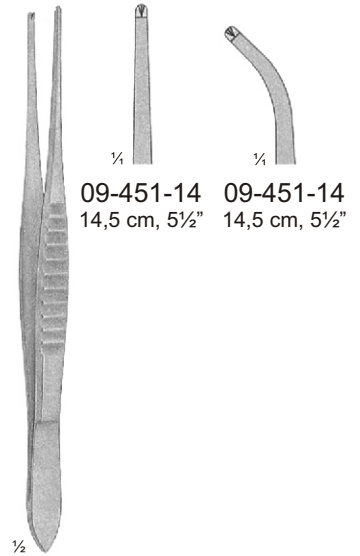

09-451-14
14,5 cm, 5½"

09-451-14
14,5 cm, 5½"

MOD-USA
09-451-14
09-451-14

1x2 Teeth
1x2 Zähne
1x2 Dientes
1x2 Dents
1x2 Denti

Narrow Patterns
Schmale Modelle
Modeios estrechos
modès étroits
modelli stretti



09-455-01
09-455-06



09-455-01
10,5 cm, 4¼"



09-455-02
10,5 cm, 4¼"



09-455-03
10,5 cm, 4¼"



09-455-04
10,5 cm, 4¼"



09-455-05
10,5 cm, 4¼"



09-455-06
10,5 cm, 4¼"

1x2 Teeth
1x2 Zähne
1x2 Dientes
1x2 Dents
1x2 Denti

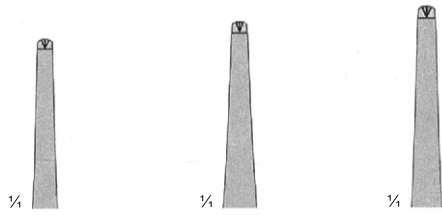

09-461-10
09-463-10
10,5 cm, 4 1/8"

09-461-12
09-463-12
12 cm, 4 3/4"

09-461-13
09-463-13
13 cm, 5"

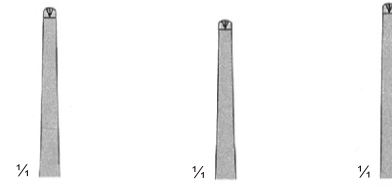

09-467-10
09-469-10
10,5 cm, 4 1/8"

09-467-12
09-469-12
12 cm, 4 3/4"

09-467-13
09-469-13
13 cm, 5"

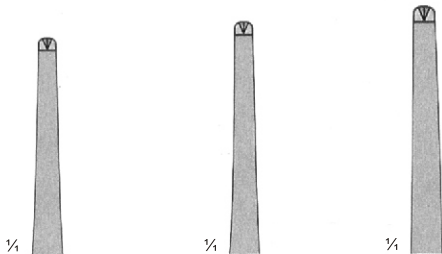

09-461-14
09-463-14
14,5 cm, 5 1/2"

09-461-16
09-463-16
16 cm, 6 1/4"

09-461-18
09-463-18
18,5 cm, 7 1/4"

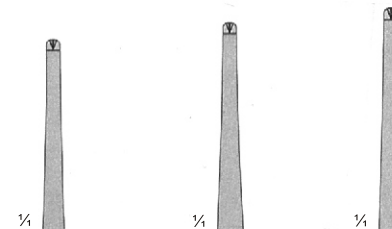

09-467-14
09-469-14
14,5 cm, 5 1/2"

09-467-16
09-469-16
16 cm, 6 1/4"

09-467-18
09-469-18
18,5 cm, 7 1/4"

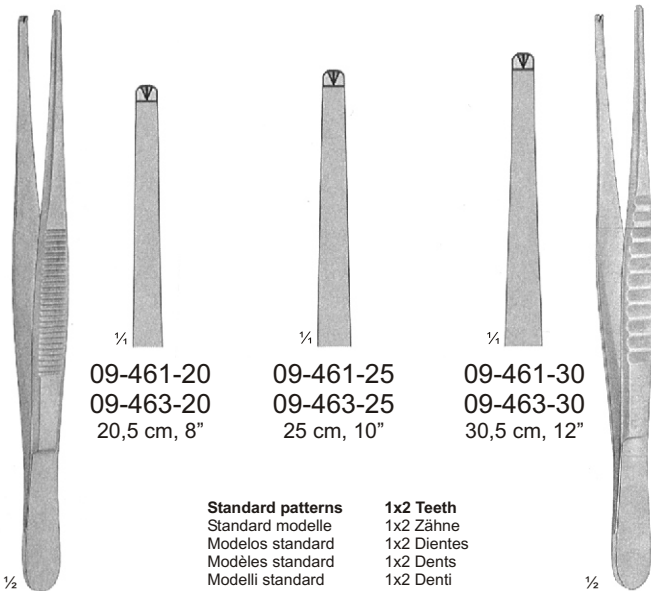

09-461-20
09-463-20
20,5 cm, 8"

09-461-25
09-463-25
25 cm, 10"

09-461-30
09-463-30
30,5 cm, 12"

Standard patterns
 Standard modelle
 Modelos standard
 Modèles standard
 Modelli standard

1x2 Teeth
 1x2 Zähne
 1x2 Dientes
 1x2 Dents
 1x2 Denti

MOD-USA

09-461-10
09-461-30

09-463-10
09-463-30

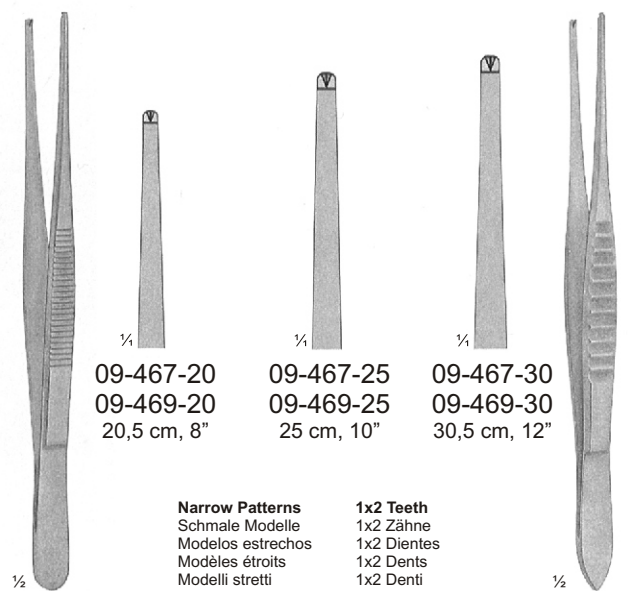

09-467-20
09-469-20
20,5 cm, 8"

09-467-25
09-469-25
25 cm, 10"

09-467-30
09-469-30
30,5 cm, 12"

Narrow Patterns
 Schmale Modelle
 Modelos estrechos
 Modèles étroits
 Modelli stretti

1x2 Teeth
 1x2 Zähne
 1x2 Dientes
 1x2 Dents
 1x2 Denti

MOD-USA

09-467-10
09-467-30

09-469-10
09-469-30

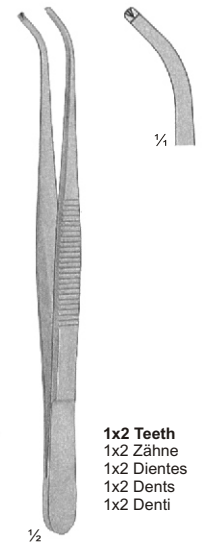
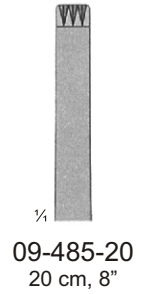
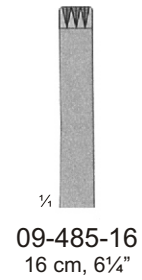
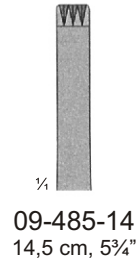
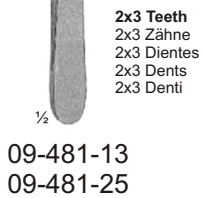
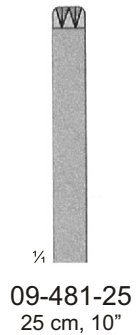
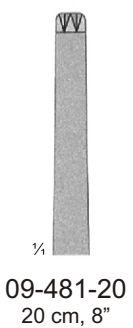
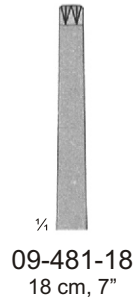
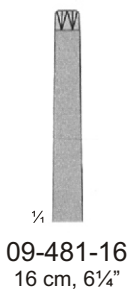
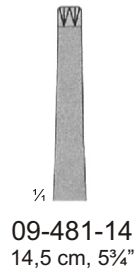
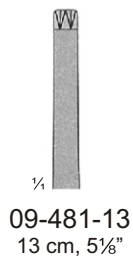

Narrow Pattern
Schmales Modell
Modelo estrecho
Modèle étroit
Modello stretto

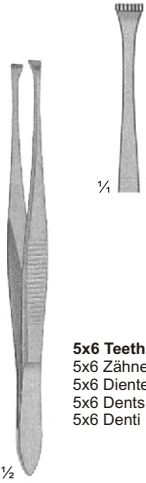

5x6 Teeth
 5x6 Zähne
 5x6 Dientes
 5x6 Dents
 5x6 Denti

GRAEFE
 09-501-11
 11 cm, 4³/₄"

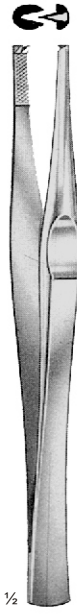

1x2 Teeth
 1x2 Zähne
 1x2 Dientes
 1x2 Dents
 1x2 Denti

LANE
 09-507-14 14 cm, 5³/₄"
 09-507-20 20 cm, 8"

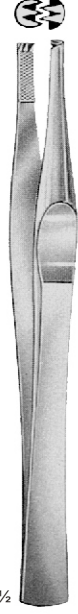

2x3 Teeth
 2x3 Zähne
 2x3 Dientes
 2x3 Dents
 2x3 Denti

LANE
 09-509-14 14 cm, 5³/₄"
 09-509-20 20 cm, 8"



09-511-15
 15 cm, 6"



09-511-20
 20 cm, 8"



09-511-25
 25 cm, 10"

Tissue seizing forceps
 Gewebefäßpinzetten
 Pinzas agarre de tejidos
 Pincas pour saisir les tissus
 Pinze da presa per tessuti

BROWN
 09-511-15
 09-511-25

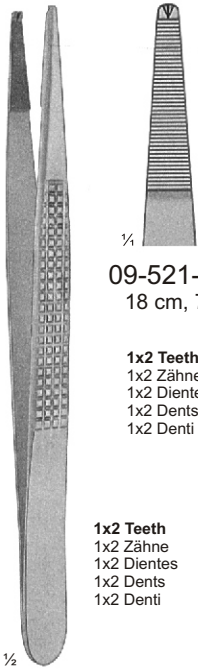

1x2 Teeth
 1x2 Zähne
 1x2 Dientes
 1x2 Dents
 1x2 Denti

BONNEY
 09-521-18
 09-523-18



09-521-18
 18 cm, 7"

1x2 Teeth
 1x2 Zähne
 1x2 Dientes
 1x2 Dents
 1x2 Denti



09-523-18
 18 cm, 7"

2x3 Teeth
 2x3 Zähne
 2x3 Dientes
 2x3 Dents
 2x3 Denti



1x2 Teeth
 1x2 Zähne
 1x2 Dientes
 1x2 Dents
 1x2 Denti

FERRIS-SMITH
 09-527-18
 09-529-18



09-527-18
 18 cm, 7"



09-529-18
 18 cm, 7"



Vascular and tumor forceps
 Gefäß- und Tumorphinzetten
 Pinzas para vasos y tumores
 Pincas pour vaisseaux et tumeurs
 Pinza vascolare e per tumori

ADLERKREUTZ
 09-541-14
 09-541-24



09-541-14
 14,5 cm, 5³/₄"

4x5 Teeth
 4x5 Zähne
 4x5 Dientes
 4x5 Dents
 4x5 Denti

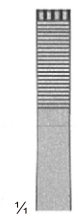

09-541-20
 20 cm, 8"

4x5 Teeth
 4x5 Zähne
 4x5 Dientes
 4x5 Dents
 4x5 Denti



09-541-24
 24,5 cm, 8"

6x7 Teeth
 6x7 Zähne
 6x7 Dientes
 6x7 Dents
 6x7 Denti

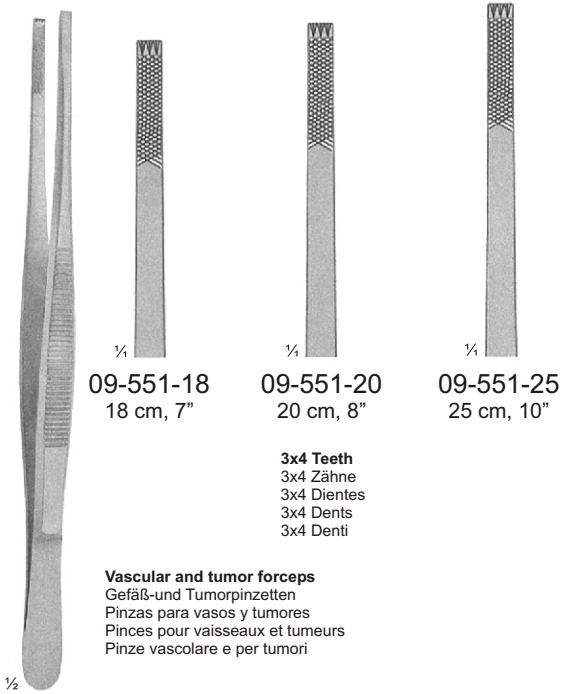

09-551-18
18 cm, 7"

09-551-20
20 cm, 8"

09-551-25
25 cm, 10"

3x4 Teeth
 3x4 Zähne
 3x4 Dientes
 3x4 Dents
 3x4 Dentì

Vascular and tumor forceps
 Gefäß- und Tumorphinzetten
 Pinzas para vasos y tumores
 Pincas pour vaisseaux et tumeurs
 Pinze vascolare e per tumori

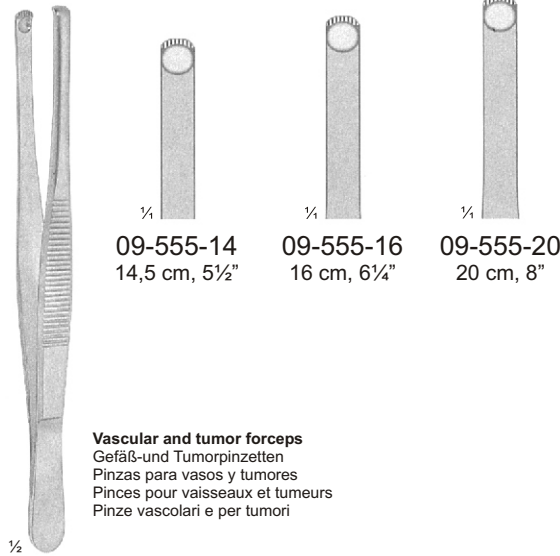

09-555-14
14,5 cm, 5½"

09-555-16
16 cm, 6¼"

09-555-20
20 cm, 8"

Vascular and tumor forceps
 Gefäß- und Tumorphinzetten
 Pinzas para vasos y tumores
 Pincas pour vaisseaux et tumeurs
 Pinze vascolari e per tumori

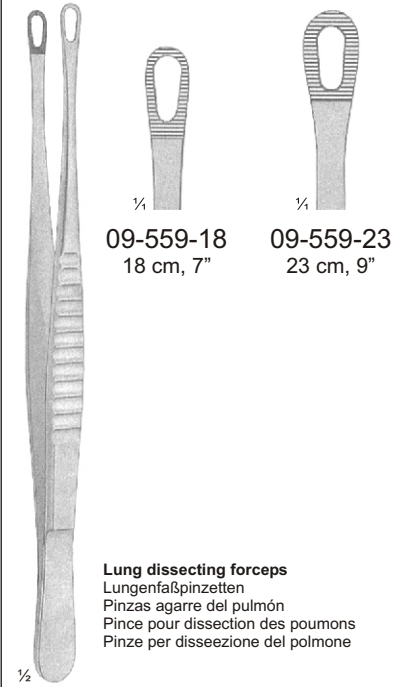

09-559-18
18 cm, 7"

09-559-23
23 cm, 9"

Lung dissecting forceps
 Lungenfaßpinzetten
 Pinzas agarre del pulmón
 Pince pour dissection des poumons
 Pinze per dissezione del polmone

STILLE
 09-551-18
 09-551-25

DURANTE
 09-555-14
 09-555-20

SINGLEY-TUTTLE
 09-559-18
 09-559-23

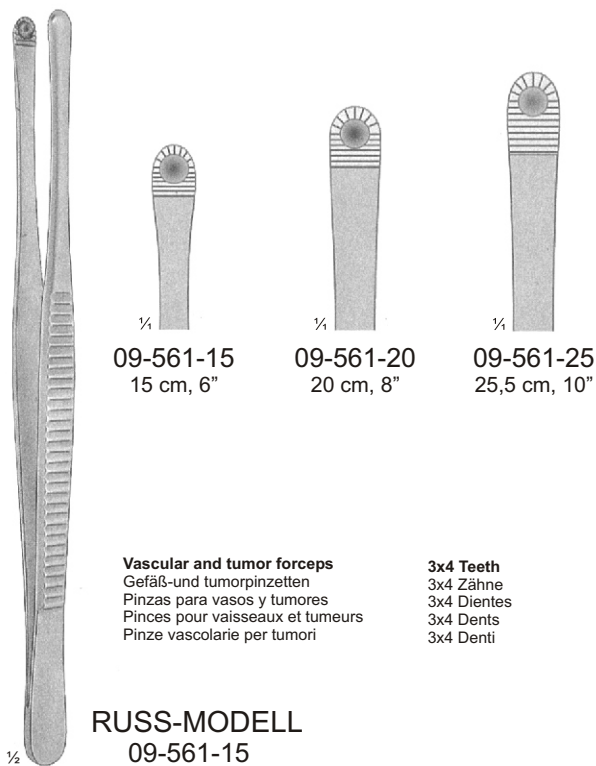

09-561-15
15 cm, 6"

09-561-20
20 cm, 8"

09-561-25
25,5 cm, 10"

Vascular and tumor forceps
 Gefäß- und Tumorphinzetten
 Pinzas para vasos y tumores
 Pincas pour vaisseaux et tumeurs
 Pinze vascolare e per tumori

3x4 Teeth
 3x4 Zähne
 3x4 Dientes
 3x4 Dents
 3x4 Dentì

RUSS-MODELL
 09-561-15
 09-561-25

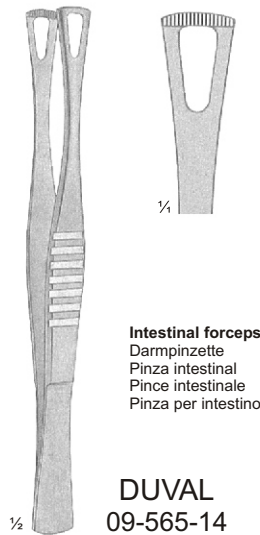

DUVAL
 09-565-14
 14 cm, 5½"

Intestinal forceps
 Darmpinzette
 Pinza intestinal
 Pince intestinale
 Pinza per intestino

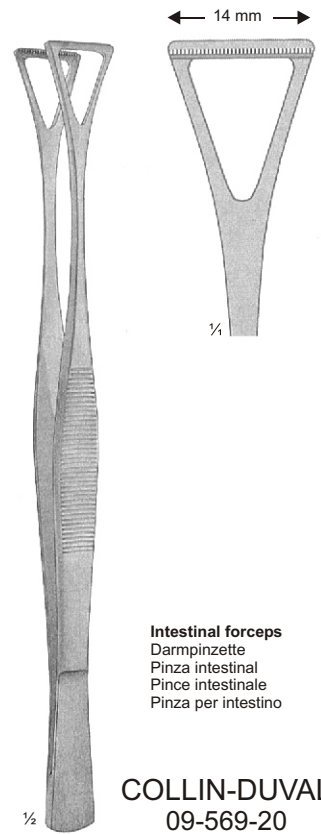

COLLIN-DUVAL
 09-569-20
 20 cm, 8"

Intestinal forceps
 Darmpinzette
 Pinza intestinal
 Pince intestinale
 Pinza per intestino



09-570-08
8,5 cm, 3³/₄"



09-570-10
10 cm, 4"



09-570-12
12,5 cm, 5"



09-570-14
14 cm, 5¹/₂"



09-570-08
09-571-14



09-571-08
8,5 cm, 3³/₄"



09-571-10
10 cm, 4"



09-571-12
12,5 cm, 5"



09-571-14
14 cm, 5¹/₂"

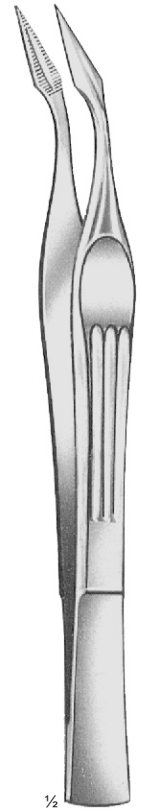

WALTER-CARMALT
 09-584-10 09-585-10
 10,5 cm, 4¹/₄" 10,5 cm, 4¹/₄"



09-574-10
10,5 cm, 4¹/₄"



09-576-07
7,5 cm, 3"



09-576-09
9 cm, 3¹/₂"

With magnifying loupe
 Mit Lupe
 Con lente de aumento
 Avec loupe
 Con lente di ingrandimento



09-575-10
10,5 cm, 4¹/₄"



09-576-11
11,5 cm, 4¹/₂"



HUNTER
 09-574-10
 09-575-10



FEILCHENFELD
 09-576-08
 09-576-11

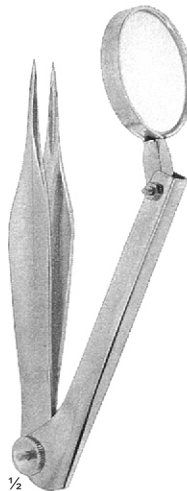

FEILCHENFELD
 09-578-12
 12 cm, 4³/₄"

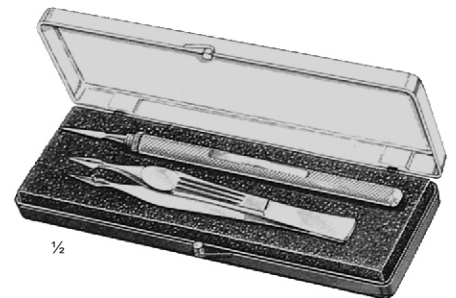

09-588-00



09-830-13
 13,5 cm, 5½"

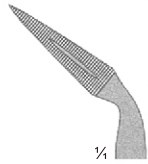

09-831-13
 13,5 cm, 5½"

STIEGLITZ
 09-830-13
 09-831-13

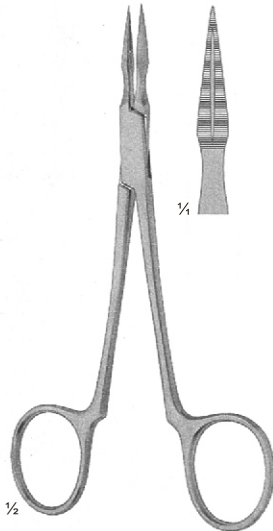

ARTHUR
 09-592-14
 14 cm, 5½"

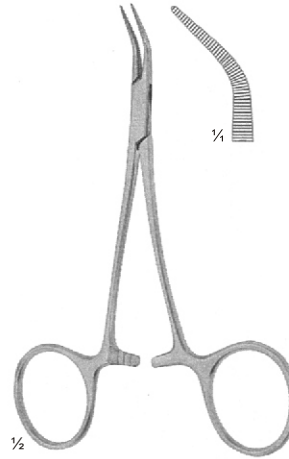

PEET
 09-595-11
 11,5 cm, 4½"

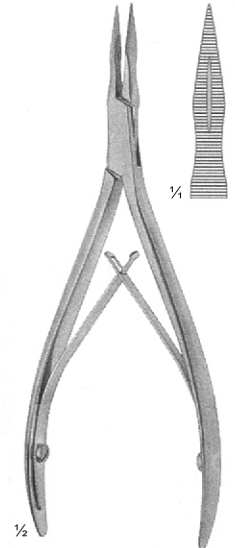

RALKS
 09-598-15
 15 cm, 6"

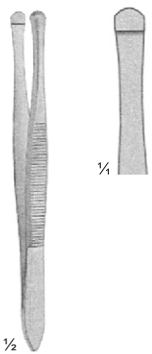

BEER
 09-602-09
 9 cm, 3½"

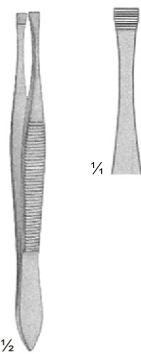

LITTAUER
 09-604-08
 8,5 cm, 3½"

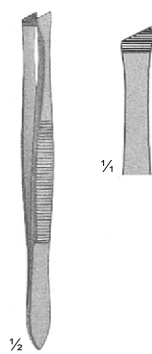

09-606-09
 9 cm, 3½"

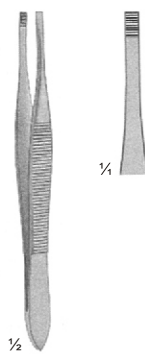

DOUGLAS
 09-608-09
 9 cm, 3½"

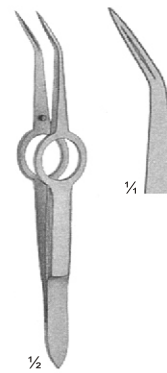

SHAAF
 09-609-09
 9 cm, 3½"

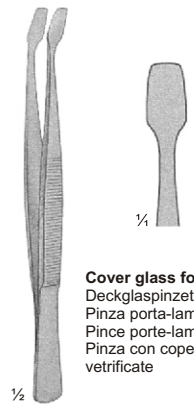

Cover glass forceps
 Deckglaspinzette
 Pinza porta-laminilla
 Pince porte-laminaires
 Pinza con copertura
 vetrificate
KUHNE
 09-610-10
 10 cm, 4½"