

015



**Suture Instruments**  
**Nahtinstrumente**  
**Instrumentos para sutura**  
**Instrumenti a suture**  
**Strumenti per sutura**

**Boomerang Needle Holders**

Bumerang-Nadelhalter  
Porta-agujas de bumerang  
Porte-aiguilles boomerangs  
Portaghi a boomerang

**Reverdin Needles**

Reverdin-Nadeln  
Agujas de Reverdin  
Aiguilles de Reverdin  
Aghi di Reverdin

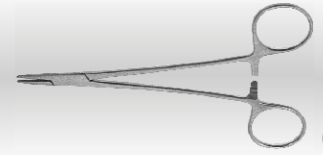

015



1/2

**YOUNG  
MILLIN**

15-550-21  
21,5 cm, 8½"

**Boomerang needle holder  
with 1 needle 15-502-21**

Bumerang-nadelhalter  
mit 1 nadel 15-502-21

Porta-aguja de bumerang  
con 1 aguja 15-502-21

Porte-aiguilles boomerang  
avec 1 aiguille 15-502-21

Portaghi a boomerang con  
1 ago 15-502-21

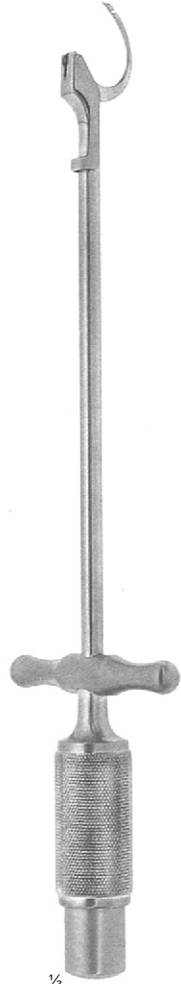

1/2

**YOUNG  
HRYNTSCHAK**

15-552-25  
25 cm, 10"

**Boomerang needle holder  
with 1 needle 15-504-26**

Bumerang-nadelhalter  
mit 1 nadel 15-504-26

Porta-aguja de bumerang  
con 1 aguja 15-504-26

Porte-aiguilles boomerang  
avec 1 aiguille 15-504-26

Portaghi a boomerang con  
1 ago 15-504-26

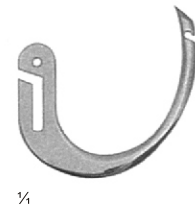

1/4

15-558-01



1/4

15-558-02



1/4

15-558-03

**Spare needles**  
Ersatznadeln  
agujas de repuesto  
aiguilles de rechange  
aghi di ricambio

15-558-01  
15-558-03



1/2

**REVERDIN**  
15-560-01  
15-560-04



1/4

15-560-01  
14 cm, 5½"



1/4

15-560-02  
14 cm, 5½"



1/4

15-560-03  
14 cm, 5½"



1/4

15-560-04  
14 cm, 5½"



**Reverdin Needles**  
 Reverdin-Nadeln  
 Aguja de Reverdin  
 Aiguilles de Reverdin  
 Aghi di Reverdin

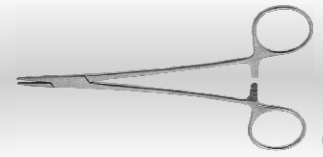

015



15-570-01 15-570-02 15-570-03 15-570-04  
 19,5 cm, 7¾" 19,5 cm, 7¾" 19,5 cm, 7¾" 19,5 cm, 7¾"



REVERDIN  
 15-570-01  
 15-570-04

½



15-572-01 15-572-02 15-572-03 15-572-04  
 23 cm, 9" 23 cm, 9" 23 cm, 9" 23 cm, 9"



REVERDIN  
 15-572-01  
 15-572-04

½

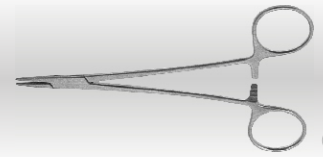

**KRONECKER**

15-580-13 13 cm, 5"  
 15-582-13 13 cm, 5"

**For the right hand, blunt**

Für die rechte hand, stumpf

Para la mano derecha, roma

pour la main droite, mousse

per la mano destra, smusso

**For the left hand, blunt**

Für die linke hand, stumpf

Para la mano izquierda, roma

pour la main gauche, mousse

per la mano sinistra, smusso

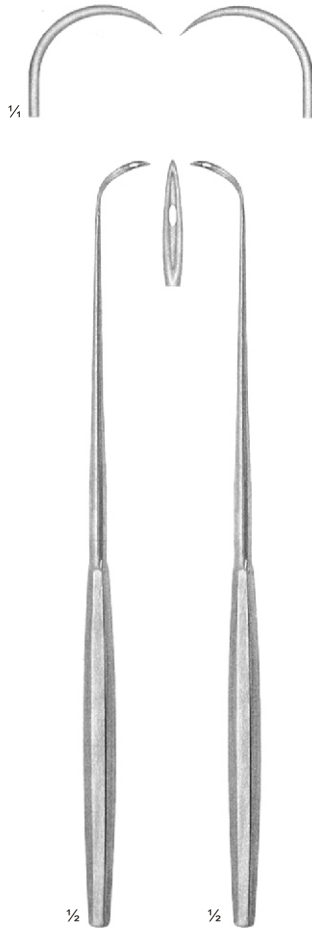

**HURD**

15-584-21 21 cm, 8¼"  
 15-586-21 21 cm, 8¼"

**For the right hand, sharp**

Für die rechte hand, scharf

Para la mano derecha, aguda

pour la main droite, pointue

per la mano destra, acuto

**For the left hand, sharp**

Für die linke hand, scharf

Para la mano izquierda, aguda

pour la main gauche, pointue

per la mano sinistra, acuto

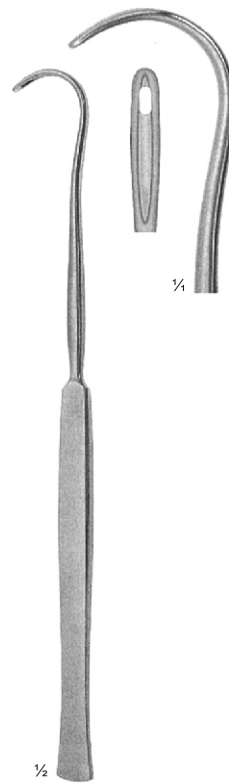

**COOPER**

15-590-19  
 19 cm, 7½"



15-598-20  
 20 cm, 8"

**Malleable**  
 Biegsam  
 Maleable  
 Malleable  
 Malleabile

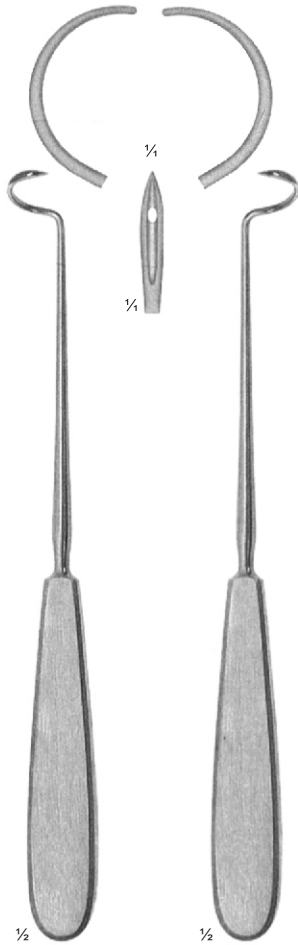

**DESCHAMPS**

**15-600-01**  
20 cm, 8"

**For the right hand, sharp**

Für die rechte hand, scharf

Para la mano derecha, aguda

pour la main droite, pointue

per la mano destra, acuto

**15-602-02**  
20 cm, 8"

**For the left hand, sharp**

Für die linke hand, scharf

Para la mano izquierda, aguda

pour la main gauche, pointue

per la mano sinistra, acuto

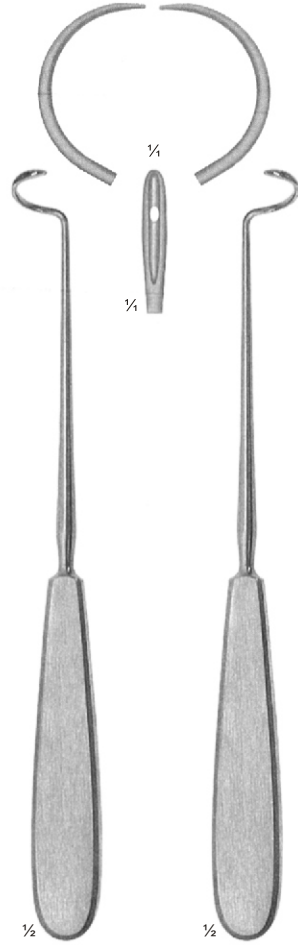

**DESCHAMPS**

**15-604-01**  
20 cm, 8"

**For the right hand, sharp**

Für die rechte hand, scharf

Para la mano derecha, aguda

pour la main droite, pointue

per la mano destra, acuto

**15-604-02**  
20 cm, 8"

**For the right hand, blunt**

Für die rechte hand, stumpf

Para la mano derecha, roma

pour la main droite, mousse

per la mano destra, smusso

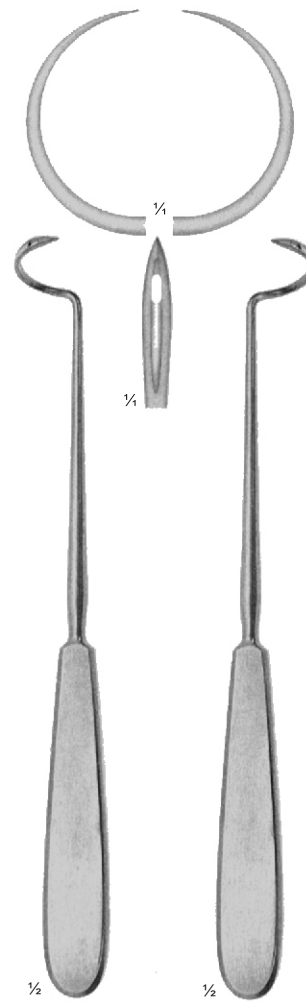

**DESCHAMPS**

**15-608-01**  
20 cm, 8"

**For the left hand, blunt**

Für die linke hand, scharf

Para la mano izquierda, aguda

pour la main gauche, pointue

per la mano sinistra, acuto

**15-608-02**  
20 cm, 8"

**For the left hand, blunt**

Für die linke hand, stumpf

Para la mano izquierda, roma

pour la main gauche, mousse

per la mano sinistra, smusso

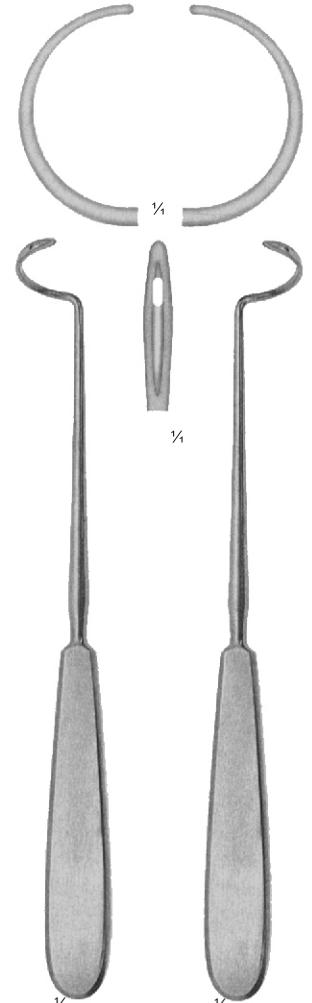

**DESCHAMPS**

**15-610-01**  
20 cm, 8"

**For the right hand, blunt**

Für die rechte hand, stumpf

Para la mano derecha, roma

pour la main droite, mousse

per la mano destra, smusso

**15-610-02**  
20 cm, 8"

**For the left hand, blunt**

Für die linke hand, stumpf

Para la mano izquierda, roma

pour la main gauche, mousse

per la mano sinistra, smusso

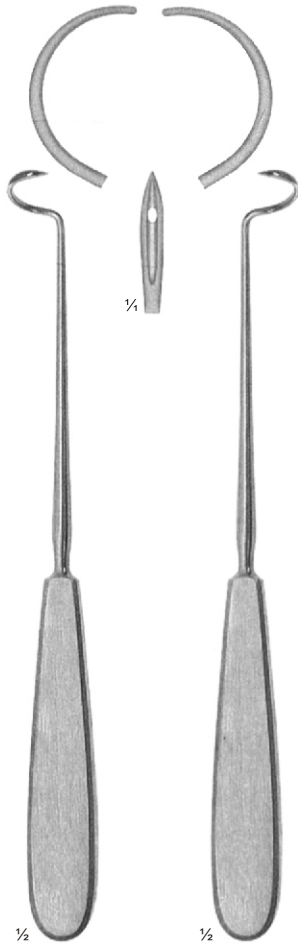

**DESCHAMPS**

**15-620-01**  
 21 cm, 8½"

**For the right hand, sharp**

Für die rechte hand, scharf

Para la mano derecha, aguda

pour la main droite, pointue

per la mano destra, acuto

**15-620-02**  
 21 cm, 8½"

**For the left hand, sharp**

Für die linke hand, scharf

Para la mano izquierda, aguda

pour la main gauche, pointue

per la mano sinistra, acuto

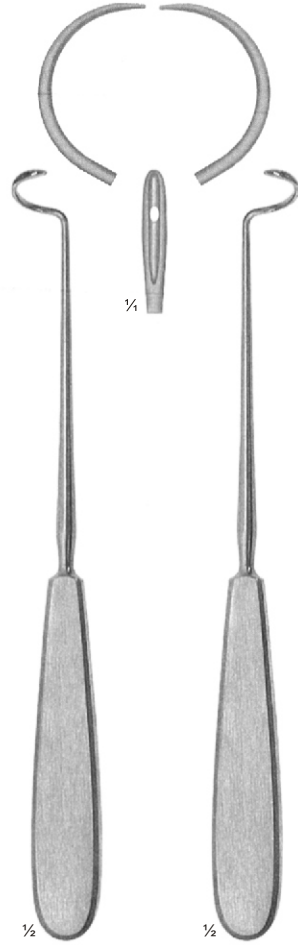

**DESCHAMPS**

**15-624-01**  
 21 cm, 8½"

**For the right hand, sharp**

Für die rechte hand, scharf

Para la mano derecha, aguda

pour la main droite, pointue

per la mano destra, acuto

**15-624-02**  
 21 cm, 8½"

**For the right hand, blunt**

Für die rechte hand, stumpf

Para la mano derecha, roma

pour la main droite, mousse

per la mano destra, smusso

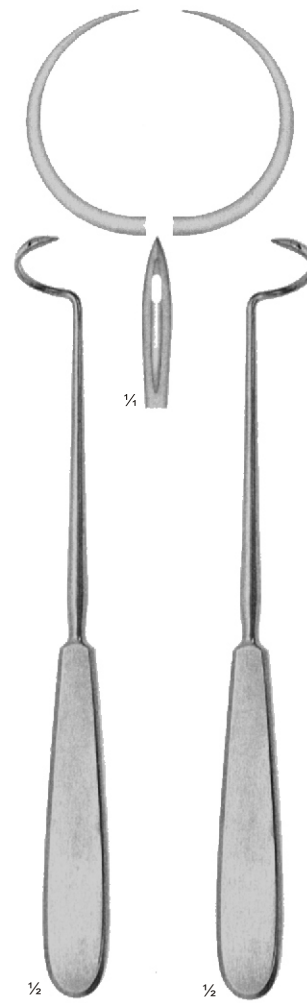

**DESCHAMPS**

**15-628-01**  
 21 cm, 8½"

**For the left hand, blunt**

Für die linke hand, scharf

Para la mano izquierda, aguda

pour la main gauche, pointue

per la mano sinistra, acuto

**15-628-02**  
 21 cm, 8½"

**For the left hand, blunt**

Für die linke hand, stumpf

Para la mano izquierda, roma

pour la main gauche, mousse

per la mano sinistra, smusso

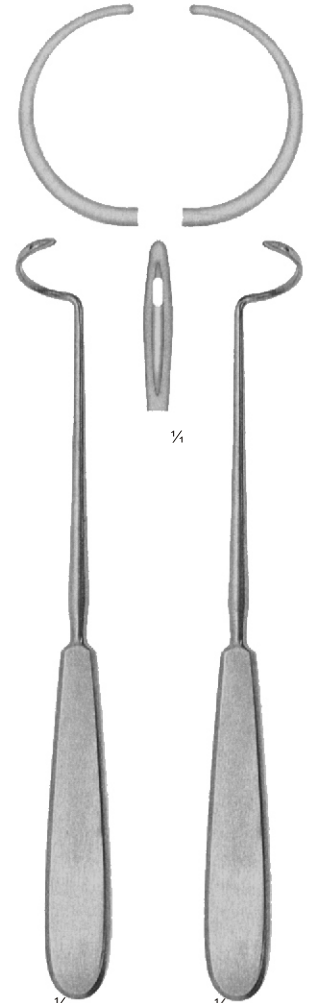

**DESCHAMPS**

**15-630-01**  
 21 cm, 8½"

**For the right hand, blunt**

Für die rechte hand, stumpf

Para la mano derecha, roma

pour la main droite, mousse

per la mano destra, smusso

**15-630-02**  
 21 cm, 8½"

**For the left hand, blunt**

Für die linke hand, stumpf

Para la mano izquierda, roma

pour la main gauche, mousse

per la mano sinistra, smusso

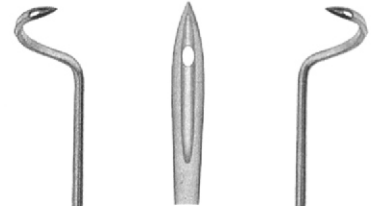
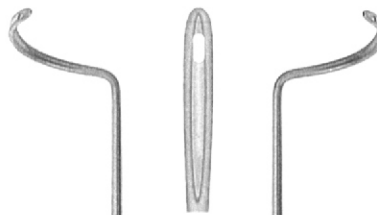
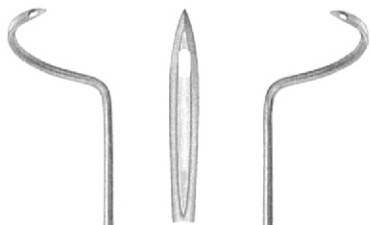
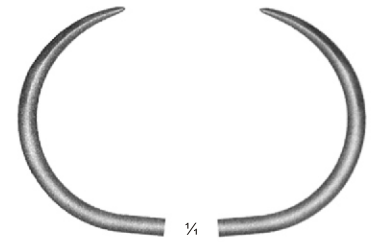
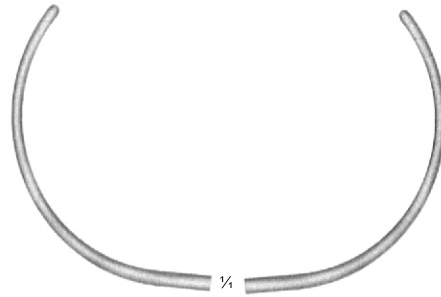
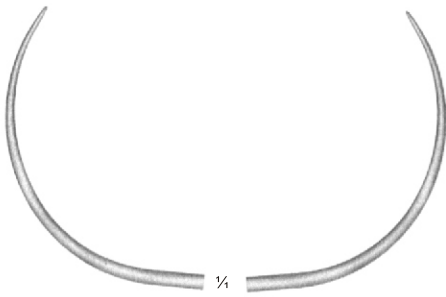
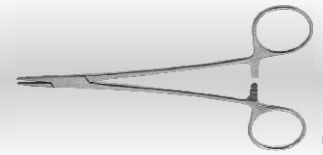

½

½

½

½

½

½

**DESCHAMPS**

15-634-01  
24 cm, 9½"

15-634-02  
24 cm, 9½"

**For the right hand, sharp**

**For the left hand, sharp**

Für die rechte hand, scharf

Für die linke hand, scharf

Para la mano derecha, aguda

Para la mano izquierda, aguda

pour la main droite, pointue

pour la main gauche, pointue

per la mano destra, acuto

per la mano sinistra, acuto

**DESCHAMPS**

15-636-01  
24 cm, 9½"

15-636-02  
24 cm, 9½"

**For the right hand, blunt**

**For the left hand, blunt**

Für die rechte hand, stumpf

Für die linke hand, stumpf

Para la mano derecha, roma

Para la mano izquierda, roma

pour la main droite, mousse

pour la main gauche, mousse

per la mano destra, smusso

per la mano sinistra, smusso

**DESCHAMPS**

15-638-01  
27 cm, 10½"

15-638-02  
27 cm, 10½"

**For the right hand, sharp**

**For the left hand, sharp**

Für die rechte hand, scharf

Für die linke hand, scharf

Para la mano derecha, aguda

Para la mano izquierda, aguda

pour la main droite, pointue

pour la main gauche, pointue

per la mano destra, acuto

per la mano sinistra, acuto

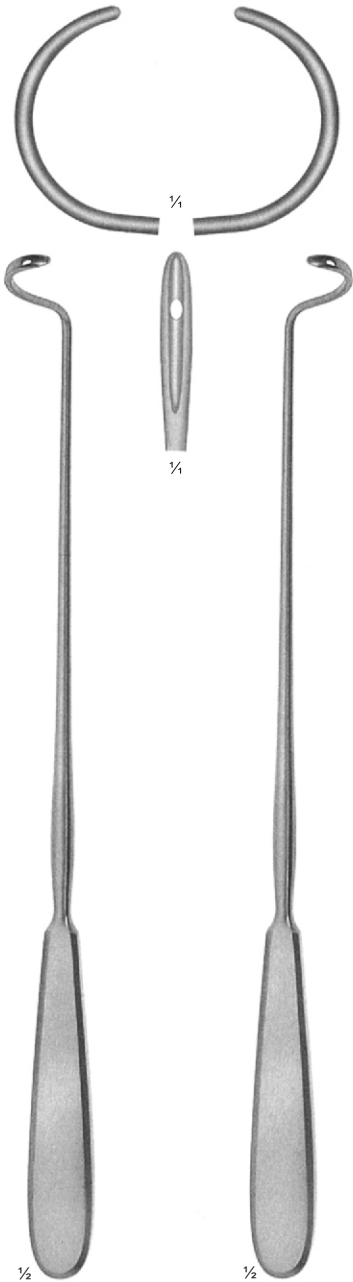
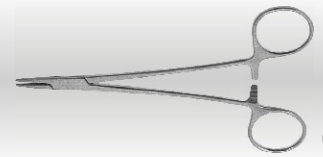

**DESCHAMPS**  
 15-640-01  
 27 cm, 10½"

**For the right hand, sharp**

Für die rechte hand, scharf

Para la mano derecha, aguda

pour la main droite, pointue

per la mano destra, acuto

**DESCHAMPS**  
 15-640-02  
 27 cm, 10½"

**For the left hand, sharp**

Für die linke hand, scharf

Para la mano izquierda, aguda

pour la main gauche, pointue

per la mano sinistra, acuto

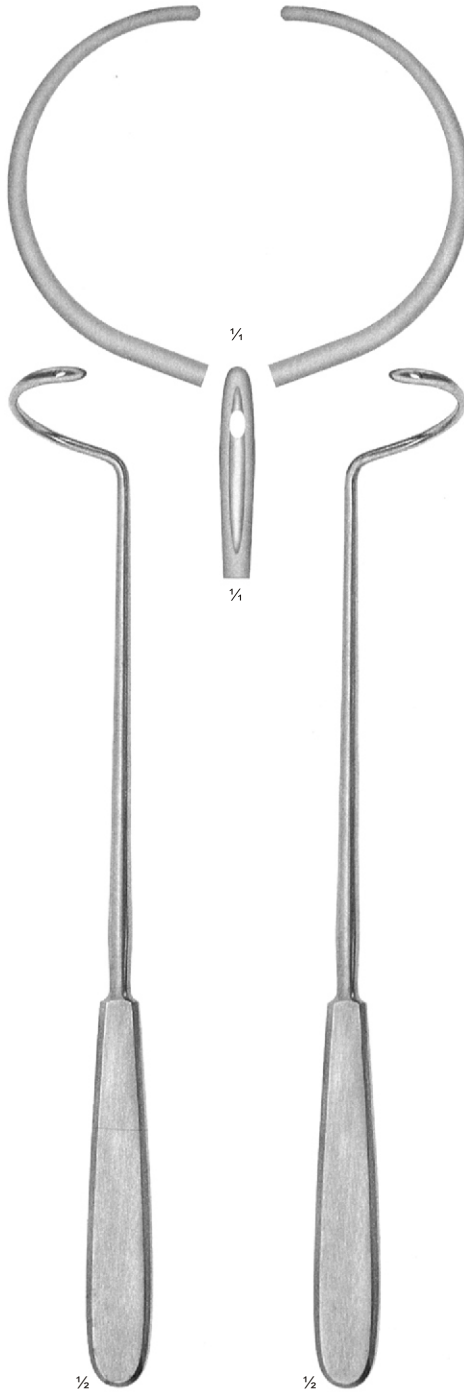

**DESCHAMPS**  
 15-644-01  
 28 cm, 11"

**For the right hand, sharp**

Für die rechte hand, scharf

Para la mano derecha, aguda

pour la main droite, pointue

per la mano destra, acuto

**DESCHAMPS**  
 15-644-02  
 28 cm, 11"

**For the left hand, sharp**

Für die linke hand, scharf

Para la mano izquierda, aguda

pour la main gauche, pointue

per la mano sinistra, acuto

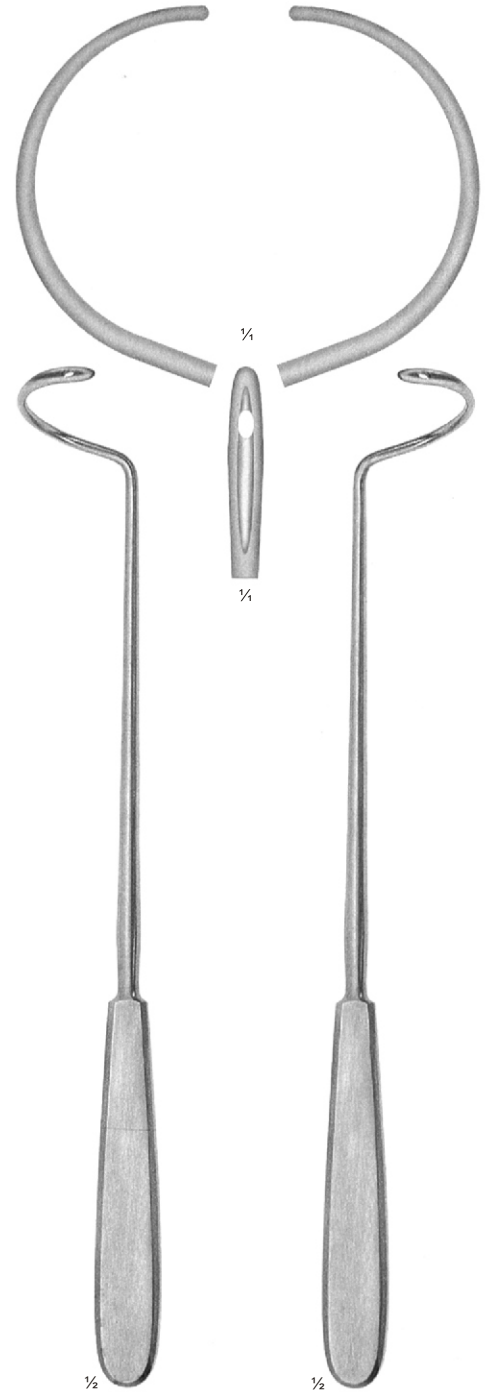

**DESCHAMPS**  
 15-646-01  
 28 cm, 11"

**For the right hand, sharp**

Für die rechte hand, scharf

Para la mano derecha, aguda

pour la main gauche, pointue

per la mano destra, acuto

**DESCHAMPS**  
 15-646-02  
 28 cm, 11"

**For the left hand, sharp**

Für die linke hand, scharf

Para la mano izquierda, aguda

pour la main gauche, pointue

per la mano sinistra, acuto



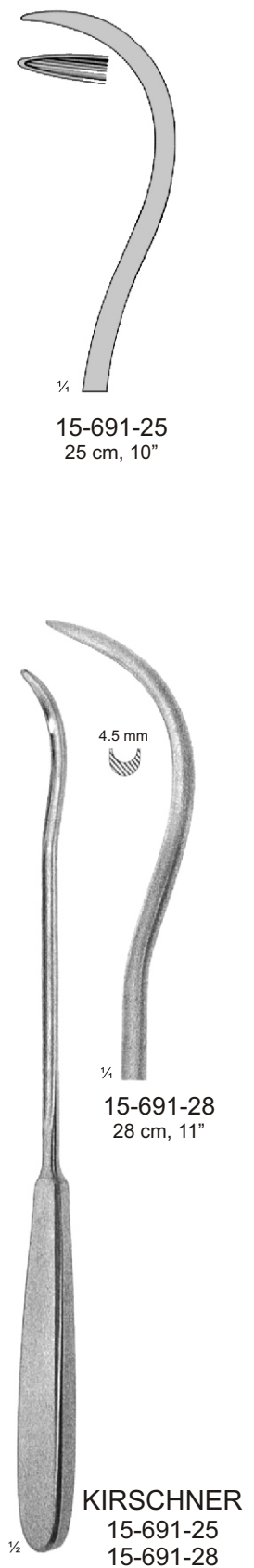
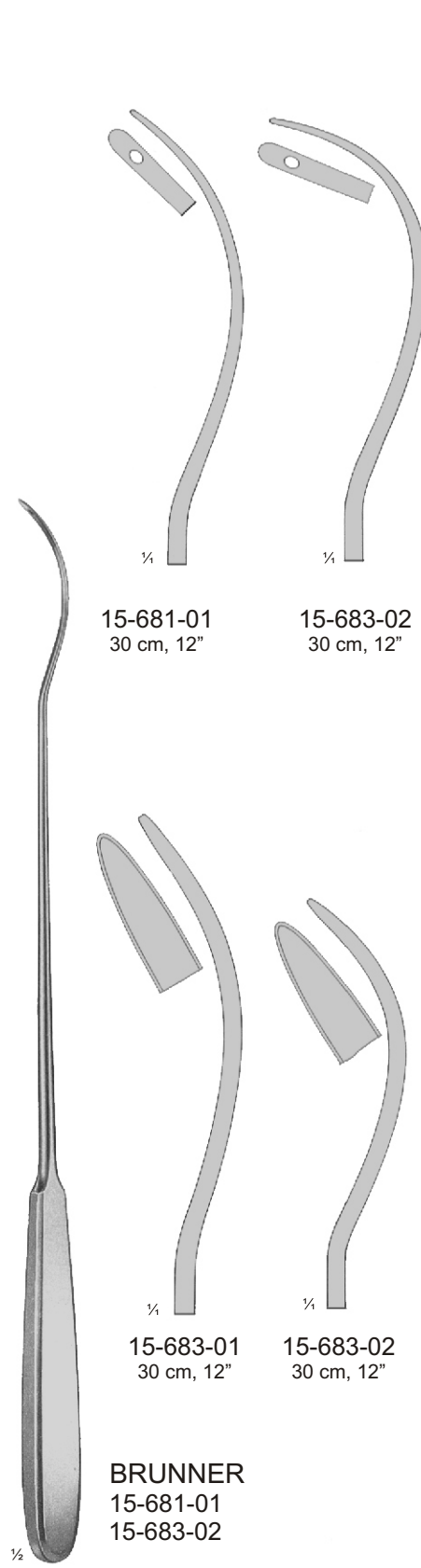
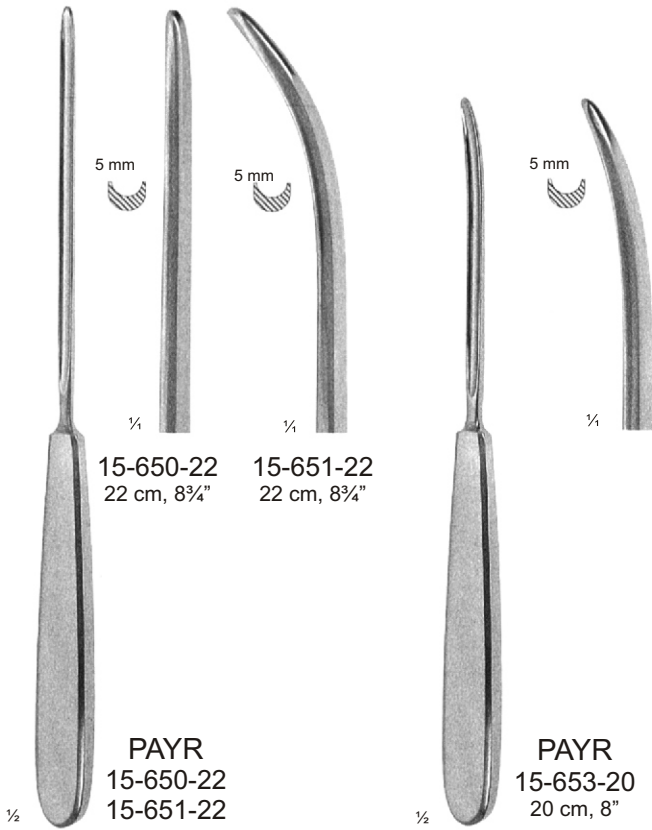
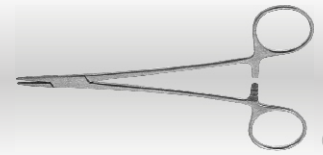

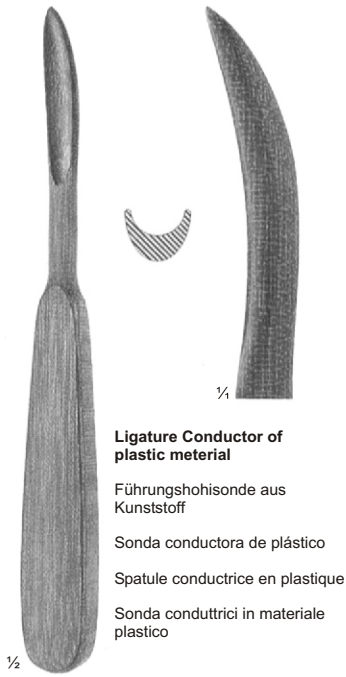
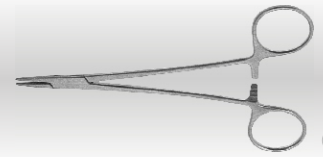

**Ligature Conductor of plastic material**

Führungshohlsonde aus Kunststoff

Sonda conductora de plástico

Spatule conductrice en plastique

Sonda conduttrici in materiale plastico

1/2

**BRUNNER-FERROZELL**

15-701-18 18 cm, 7"

15-701-27 27 cm, 10 1/2"

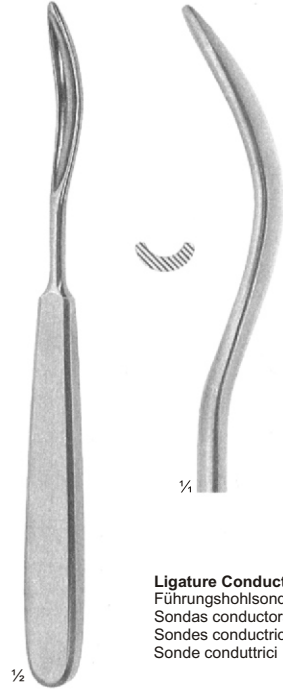

**Ligature Conductors**  
 Führungshohlsonden  
 Sondas conductoras  
 Sondes conductrices  
 Sonde conduttrici

1/2

**SCHMIEDEN**

15-703-19

19 cm, 7 1/2"

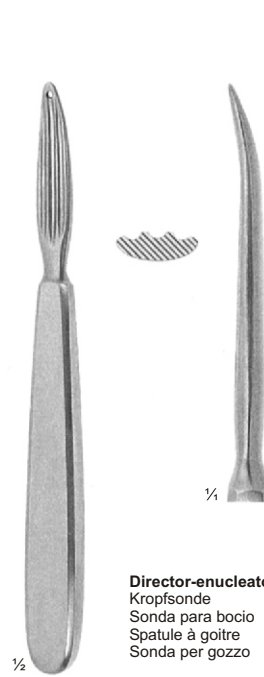

**Director-enucleator**  
 Kropfsonde  
 Sonda para bocio  
 Spatule à goitre  
 Sonda per gozzo

1/2

**KOCHER**

15-711-15

15 cm, 6"

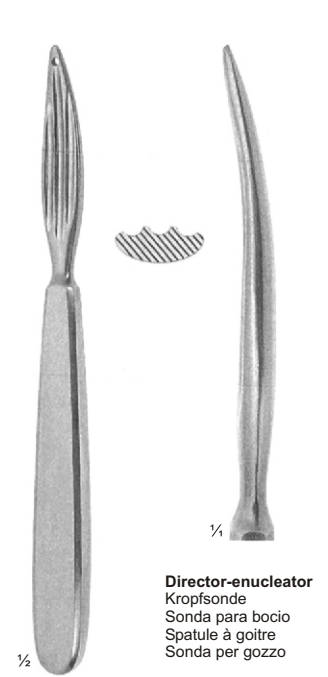

**Director-enucleator**  
 Kropfsonde  
 Sonda para bocio  
 Spatule à goitre  
 Sonda per gozzo

1/2

**KOCHER**

15-713-18

18 cm, 7"

**Approximation forceps with clip holder**

Wundnahtpinzette mit Klammerhalter

Pinza aproximadora con porta-clips

Pince à affronter sans porte agrafes

Pinza con porta clips



1/2

**CHILDE**

15-730-18

18 cm, 7"

**Approximation forceps without clip holder**

Wundnahtpinzette ohne Klammerhalter

Pinza aproximadora sin porta-clips

Pince à affronter sans porte agrafes

Pinza senza porta clips



1/2

**CHILDE**

15-732-18

18 cm, 7"

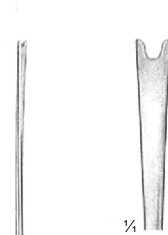

1/4

**CASPAR**

15-740-23

23 cm, 9"

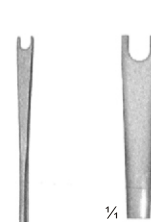

1/4

**Knot tier and ligature adjuster**

Fadenqabel  
 Horquilla para ligadura  
 Pousse fil  
 Forchetta da sutura

1/2

15-742-23

23 cm, 9"



1/4

**Suture catcher**

Fadenfänger  
 Porta ligadura  
 Porte-ligature  
 Portalegature

1/2

15-748-23

23,5 cm, 9 1/4"

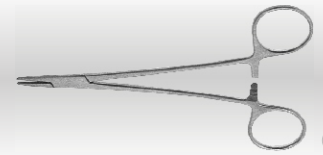

**MICHEL**  
15-700-01  
15-700-07

|  |           |               |
|--|-----------|---------------|
|  | 15-750-00 | 7,5 x 1,75 mm |
|  | 15-750-01 | 11 x 2,0 mm   |
|  | 15-750-02 | 12 x 3,0 mm   |
|  | 15-750-03 | 14 x 3,0 mm   |
|  | 15-750-04 | 16 x 3,0 mm   |
|  | 15-750-05 | 18 x 3,0 mm   |
|  | 15-750-06 | 20 x 3,0 mm   |
|  | 15-750-07 | 22 x 3,0 mm   |

**Suture clips of stainless steel, in packages of 100 pieces**  
Wundklammern aus nichtrostendem Stahl, in Packungen zu 100 Stück  
Agrafes (grapas de acero inoxidable, paquete de 100 piezas)  
Agrafes acier inoxydable, paquet de 100  
Agrafes clips da sutura in acciaio inox in conf. 100 pz.



**15-760-12**  
**09-507-14**  
12,5 cm, 5"

**Clip applying forceps**  
Klammeranlegepinzette  
Pinza para poner agrafes  
Pincès à poser les agrafes  
Pinza per metter clips



**MICHEL**  
**15-764-12**  
12 cm, 4¾"

**Clip applying forceps**  
Klammeranlegepinzette  
Pinza para poner agrafes  
Pincès à poser les agrafes  
Pinza per metter clips



**WACHENFELDT**  
**15-768-12**  
12,5 cm, 5"

**Clip applying forceps**  
Klammeranlegepinzette  
Pinza para poner agrafes  
Pincès à poser les agrafes  
Pinza per metter clips



**HEGENBARTH**  
**15-772-12**  
12,5 cm, 5"

**Clip applying forceps**  
Klammeranlegepinzette  
Pinza para poner agrafes  
Pincès à poser les agrafes  
Pinza per metter clips



**MICHEL**  
**15-780-12**  
12 cm, 4¾"

**Clip applying and removing forceps**  
Klammeranlege- und Entfernungszange  
Pinza para poner y quitar agrafes  
Pincès à poser et retirer les agrafes  
Pinza per mettere e togliere clips

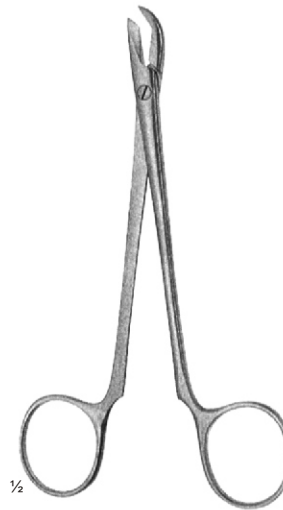

**COLLIN**  
**15-760-13**  
13 cm, 5"

**Clip removing forceps**  
Klammerentfernungszange  
Pinza para quitar agrafes  
Pincès à retirer les agrafes  
Pinza per togliere clips

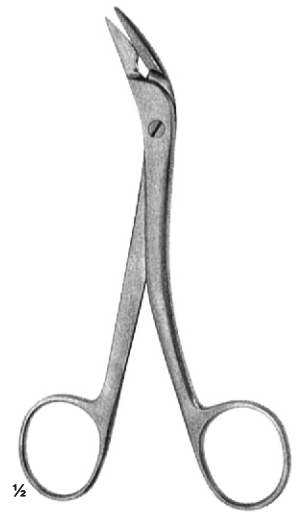

**RICHTER-HEATH**  
**15-762-14**  
14 cm, 5½"

**Clip removing forceps**  
Klammerentfernungszange  
Pinza para quitar agrafes  
Pincès à retirer les agrafes  
Pinza per togliere clips

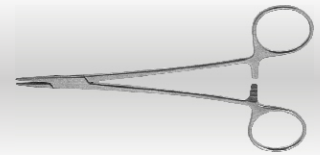

**Suturing instrument set, complete, consisting of:**

- 3 Sterile scalpel blade No. 23
- 1 Scalpel handle No. 4
- 1 Scissors, blunt/sharp, straight, 13 cm, 5/8"
- 1 SEMKEN Dissecting forceps, 12 cm, 4 3/4"
- 1 Suture silk No. 1, twisted, hank of 0.5 gramme, sterilized, in glass flacon
- 1 Surgical suture needle B, fig. 12
- 1 Surgical suture needle G, fig. 11
- 1 Surgical suture needle G, fig. 15
- 1 Needle sterilizing box, 50 x 25 x 4.5, mm
- 1 MATHIEU needle holder, 14 cm, 5 1/2"
- 1 MICHEL Clip applying and removing forceps, 12.5 cm, 5"
- 25 MICHEL Suture clips. 16 x 3 mm
- 1 Metal case, 165 x 90 x 23 mm

**Wundnahtbesteck, komplett, bestehend aus:**

- 3 Sterile Skalpellklingen No. 4
- 1 Schere, spitz/stumpf, gerade, 13 cm, 5/8"
- 1 SEMKEN Anatomische Pinzette 12 cm 4 3/4"
- 1 Nähseide No. 1, gedreht, Strang zu 0,5 g., steril, im Glasflacon
- 1 Chirurgische Nähnadel B, Fig. 12
- 1 Chirurgische Nähnadel G, Fig. 11
- 1 Chirurgische Nähnadel G, Fig. 15
- 1 Nadel-Sterilisierdose 50 x 25 x 4,5 mm
- 1 MATHIEU Nadelhalter 14 cm, 15 1/2"
- 1 MICHEL Klammeranlege- und Entfernungszange 12,5 cm, 5"
- 25 MICHEL Wundklammern 16 x 3 mm
- 1 Metall-Etui 165 x 90 x 23 mm

**Estuche para sutura, completo, compuesto de:**

- 3 Hojas de bisturíes núm. 23, estériles
- 1 Mango de bisturí núm. 4
- 1 Tijera, roma/aguda, recta, 13 cm, 5/8"
- 1 Pinza de disección de SEMKEN, 12 cm, 4 3/4"
- 1 Seda para sutura, núm. 1 hilado, madeja de 0,5 gr., eatéil, en frasquito de vidrio
- 1 Aguja para sutura cirujía B, núm. 12
- 1 Aguja para sutura cirujía G, núm. 11
- 1 Aguja para sutura cirujía G, núm. 15
- 1 Estuche para esterilizar agujas, 50 x 25 x 4,5 mm
- 1 Porta-agujas de MATHIEU, 14 cm 5 1/2"
- 1 Pinza para poner y quitar agrafes de MICHEL, 12,5 cm, 5"
- 25 Agrafes (grapas) de MICHEL, 16 x 3 mm
- 1 Estuch de metal, 165 x 90 x 23 mm

**Nécessaire à suture, complet, composé de:**

- 3 Paquets de lames No. 23
- 1 Manche No. 4
- 1 Ciseaux, pointu/mousse, droits, 13 cm, 5/8"
- 1 Pince à dissection de SEMKEN, 12 cm, 4 3/4"
- 1 Soie à suture No. 1, torsadée, fil de 0,5 g, stérile en flacon verre
- 1 Aiguilles à sutures B, fig. 12
- 1 Aiguilles à sutures G, fig. 11
- 1 Aiguilles à sutures G, fig. 15
- 1 Boîte à stériliser les aiguilles, 50 x 25 x 4,5 mm
- 1 Porte-aiguille de MATHIEU, 14 cm, 5 1/2"
- 1 Pince à poser et retirer les agrafes de MICHEL, 12,5 cm, 5"
- 25 Agrafes de MICHEL, 16 x 3 mm
- 1 Boîte métal, 165 x 90 x 23 mm

**Set per sutura, completo, composto da:**

- 3 lame per bisturí fig. 23
- 1 Bisturí a lame No. 4
- 1 Forbice, acuta/smussa, retta, 13 cm, 5/8"
- 1 Pinza anatomica SEMKEN, 12 cm, 4 3/4"
- 1 Seta intrecciata, No. 1, 0,5 g, sterilizzabile in flacon vetro
- 1 Ago chirurgica per suturea B, fig. 12
- 1 Ago chirurgica per suturea G, fig. 11
- 1 Ago chirurgica per suturea G, fig. 15
- 1 Scatola per sterilizzazione per aghi, 50 x 25 x 4,5 mm
- 1 Portaghi MATHIEU, 14 cm, 5 1/2"
- 1 Pinza MICHEL per mettere e togliere clips, 12,5 cm, 5"
- 25 Agrafes MICHEL, 16 x 3 mm
- 1 Scatola metallica, 165 x 90 x 23 mm

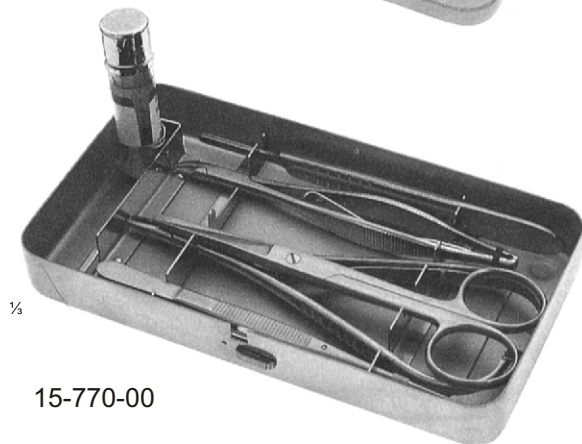
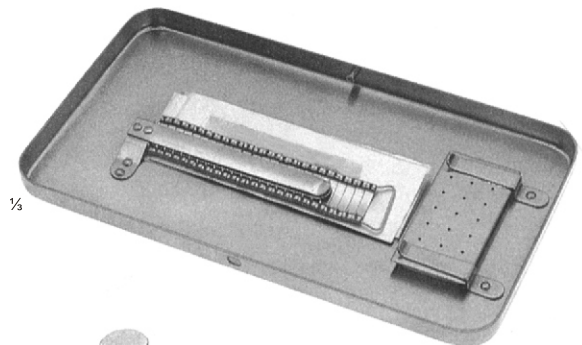

15-770-00