

019
021



Probes, Trocars, Suction Tubes, Syringes
Sonden, Trokare, Saugrohre, Spritzen
Sondas, Trócares, Tubos de aspiración, Jeringas
Sondes, Trocart, Canules d'aspiration, Seringues
Sonde, Trequarti, Tubi aspirazione, Siringhe



19-100-01
19-102-06
13 cm, 5 1/8"

| Silver Silber Plata Argent Argento | German silver Neusilber Plata meneses Argent blanc Argento bianco | Fig. | ø mm | Silver Silber Plata Argent Argento | German silver Neusilber Plata meneses Argent blanc Argento bianco |
|--|---|------------|-----------|--|---|
| 19-100-01 | 19-102-01 | 0000 / 000 | 0,4 / 0,6 | 19-106-01 | 19-108-01 |
| 19-100-02 | 19-102-02 | 00 / 0 | 0,7 / 0,8 | 19-106-02 | 19-108-02 |
| 19-100-03 | 19-102-03 | 1 / 2 | 0,9 / 1,1 | 19-106-03 | 19-108-03 |
| 19-100-04 | 19-102-04 | 3 / 4 | 1,3 / 1,4 | 19-106-04 | 19-108-04 |
| 19-100-05 | 19-102-05 | 5 / 6 | 1,5 / 1,6 | 19-106-05 | 19-108-05 |
| 19-100-06 | 19-102-06 | 7 / 8 | 1,8 / 1,9 | 19-106-06 | 19-108-06 |

Lachrymal probes, cylindrical / cylindrical
Tränenkanalsonden, zylindrisch / zylindrisch
Estiletes para el canal lacrymal, cilíndricos / Cilíndricos
Stylets pour le canal lacrymal, cylindriques / cylindriques
Stiletti per canale lacrimale, cilindrici / cilindrici



19-106-01
19-108-06
13 cm, 5 1/8"

Lachrymal probes, buttoned / buttoned
Tränenkanalsonden, geknöpft / geknöpft
Estiletes para el canal lacrymal, abotonados / abotonados
Stylets pour le canal lacrymal, boutonnés / boutonnés
Stiletti per canale lacrimale, bottonuti / bottonuti

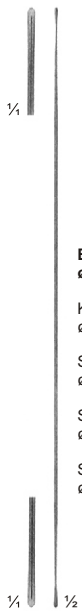

**Buttoned probes,
ø 1 mm**

Knopfsonden,
ø 1 mm

Sondas abotonadas,
ø 1 mm

Sondes boutonnées,
ø 1 mm

Sonde bottonute,
ø 1 mm

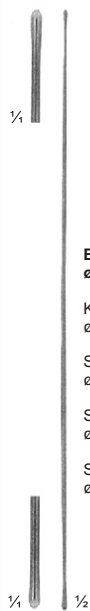

**Buttoned probes,
ø 1,5 mm**

Knopfsonden,
ø 1,5 mm

Sondas abotonadas,
ø 1,5 mm

Sondes boutonnées,
ø 1,5 mm

Sonde bottonute,
ø 1,5 mm

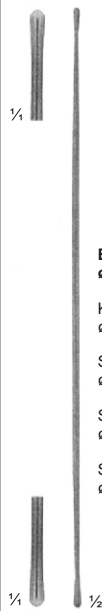

**Buttoned probes,
ø 2 mm**

Knopfsonden,
ø 2 mm

Sondas abotonadas,
ø 2 mm

Sondes boutonnées,
ø 2 mm

Sonde bottonute,
ø 2 mm

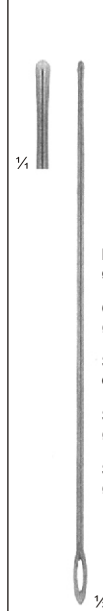

**Probes with eye,
ø 2 mm, stainless stell**

Öhrsonden,
ø 2 mm, rostfrei

Sondas con ojete, ø 2 mm,
de acero inoxidable

Styilet aigullé,
ø 2 mm, inoxydable

Sonde con occhiello,
ø 2 mm, acciaio inox

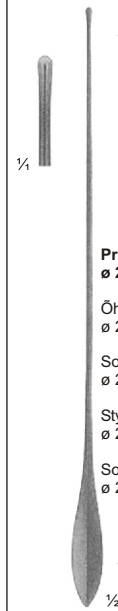

**Probes with eye,
ø 2 mm, Silber**

Öhrsonden,
ø 2 mm, Silber

Sondas con ojete,
ø 2 mm, de plata

Styilet aigullé,
ø 2 mm, argent

Sonde con occhiello,
ø 2 mm, argento

- 19-110-11 11,5 cm, 4 1/2"
- 19-110-13 13 cm, 5"
- 19-110-14 14,5 cm, 5 1/2"
- 19-110-16 16 cm, 6 1/4"
- 19-110-18 18 cm, 7"
- 19-110-20 20 cm, 8"

- 19-112-13 13 cm, 5 1/8"
- 19-112-14 14,5 cm, 5 1/2"
- 19-112-16 16 cm, 6 1/4"
- 19-112-18 18 cm, 7"
- 19-112-20 20 cm, 8"
- 19-112-25 25 cm, 10"

- 19-114-13 13 cm, 5 1/8"
- 19-114-14 14,5 cm, 5 1/2"
- 19-114-16 16 cm, 6 1/4"
- 19-114-18 18 cm, 7"
- 19-114-20 20 cm, 8"
- 19-114-25 25 cm, 10"
- 19-114-30 30 cm, 12"

- 19-120-13 13 cm, 5 1/8"
- 19-120-14 14,5 cm, 5 1/2"
- 19-120-16 16 cm, 6 1/4"
- 19-120-18 18 cm, 7"
- 19-120-20 20 cm, 8"
- 19-120-25 25 cm, 10"

- 19-122-13 13 cm, 5 1/8"
- 19-122-14 14,5 cm, 5 1/2"
- 19-122-16 16 cm, 6 1/4"
- 19-122-18 18 cm, 7"
- 19-122-20 20 cm, 8"



Director
Hohlsonde
Sonda acanalada
Sonde cannelée
Sonda scanalata

19-132-13 13 cm, 5 $\frac{1}{8}$ "
19-132-14 14,5 cm, 5 $\frac{1}{2}$ "
19-132-16 16 cm, 6 $\frac{1}{4}$ "

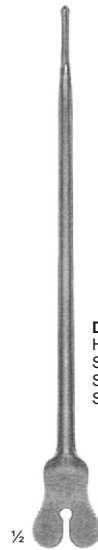

Director with button
Hohlsonden mit Knopf
Sondas acanaladas con boton
Sonde boutonées cannelées
Sonda bottonute scanalate

19-134-11 11,5 cm, 4 $\frac{1}{4}$ "
19-134-13 13 cm, 5 $\frac{1}{8}$ "
19-134-14 14,5 cm, 5 $\frac{1}{2}$ "
19-134-16 16 cm, 6 $\frac{1}{4}$ "

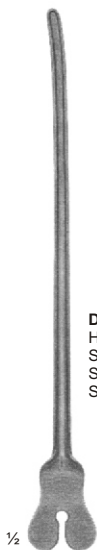

Director
Hohlsonde
Sonda acanalada
Sonde cannelée
Sonda scanalata

DOYEN
19-136-14
14 cm, 5 $\frac{1}{2}$ "

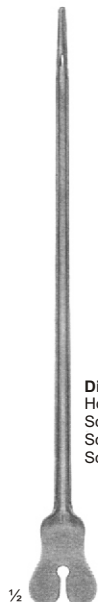

Director with button
Hohlsonden mit Knopf
Sonda acanalada con boton
Sonde boutonée cannelée
Sonda bottonuta scanalata

NELATON
19-138-16
16 cm, 6 $\frac{1}{4}$ "



**Buttoned probes,
Malleable, tin**

Knopfsonden,
biegsam, Zinn

Sondas abotonadas,
maleable, estaño

Sondes boutonées,
malléables, étain

Sonde bottonute,
malleabili, stagno

FLUHRER
19-130-01
ø 3,5 X 250 mm

19-130-02
ø 3,5 X 400 mm
40 cm, 16"



Buttoned probes
Knopfsonden
Sondas abotonadas
Sondes boutonée
Sonde bottonute

19-140-01 ø 1,5 X 300 mm
19-140-02 ø 2,0 X 300 mm
19-140-03 ø 2,5 X 300 mm



Cotton Applicators

Watteräger
Porta-algodones
Porte-cotons
Portacotone



019



¼



¼

○ 19-150-02
2 mm ø

○ 19-150-03
3 mm ø

○ 19-150-04
4 mm ø

○ 19-150-06
6 mm ø

○ 19-150-07
7 mm ø

○ 19-150-08
8,5 mm ø

○ 19-150-10
10 mm ø

○ 19-150-12
12 mm ø

○ 19-150-14
14 mm ø



½

○ 19-155-04
5,2 x 4 mm ø

○ 19-155-05
6,5 x 5 mm ø

○ 19-155-06
7,8 x 6 mm ø

○ 19-155-07
9 x 7 mm ø

○ 19-155-08
10,5 x 8 mm ø

○ 19-155-09
11,5 x 9 mm ø

○ 19-155-10
13 x 10 mm ø

VOLLMAR
19-150-02
19-150-14
50 cm, 20"

19-151-12
12 cm, 4¼"

VOLLMAR
19-155-04
19-155-10
50 cm, 20"



Vein Strippers
 Venenstripper
 Condas para várices
 Strippers à varices
 Conde per vene



019

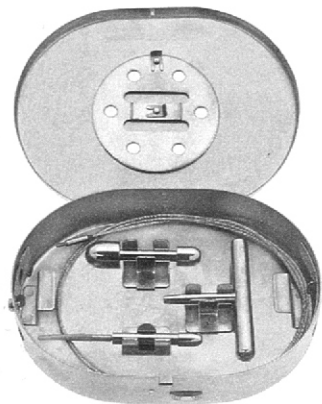
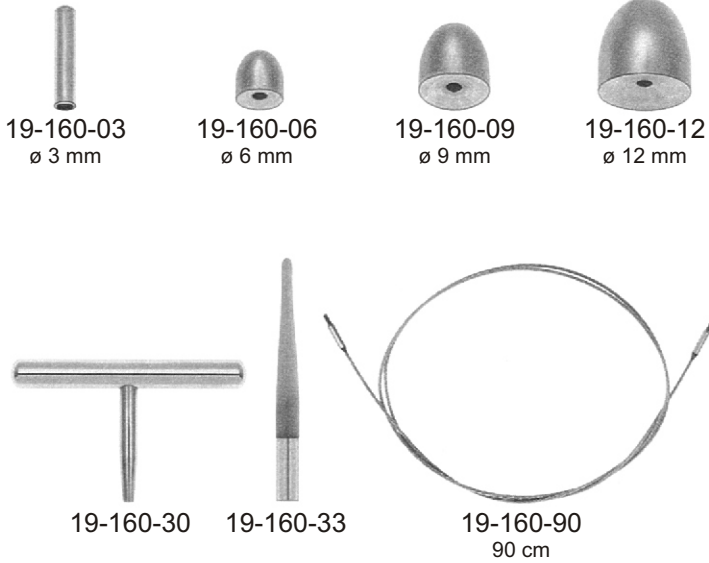

NABATOFF
19-160-00

Set , Setz , Juego , Jeu , Serie

Varicose vein probe set,
 complete, consisting of:
 19-160-01 1 Metal case 135 x 100 x 25 mm
 19-160-30 1 Handle
 19-160-03 1 Metal probe tip, ø 3 mm
 19-160-33 1 plastic probe tip
 19-160-06 1 Metal olive, ø 6 mm
 19-160-09 1 Metal olive, ø 9 mm
 19-160-12 1 Metal olive, ø 12 mm
 19-160-90 1 Flexible cable, 90 cm

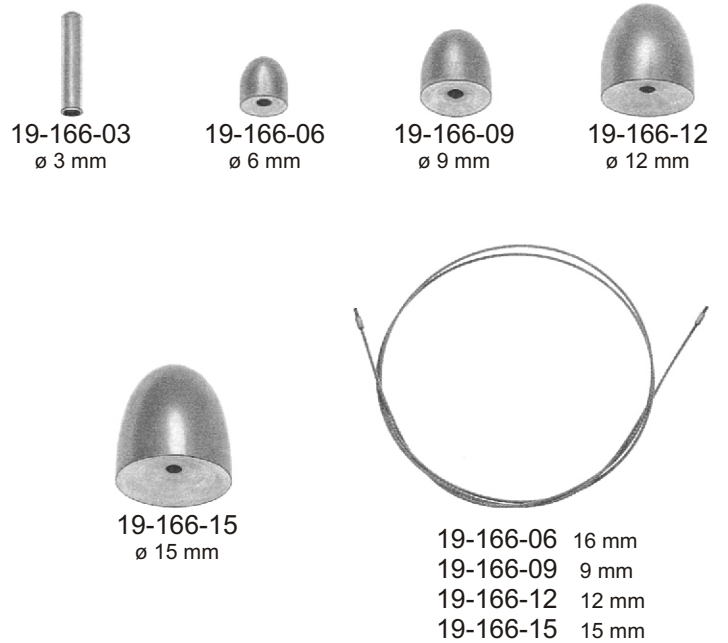

MYERS
19-166-00
Set , Setz , Juego , Jeu , Serie



| | | |
|---|--|--|
| ø 1,0 mm ¼ | ø 1,0 mm ¼ | ø 1,0 mm ¼ |
| FROHN 19-170-12 12 cm, 4¾" 19-170-14 14 cm, 5½" 19-170-16 16 cm, 6½" | FROHN 19-172-12 12 cm, 4¾" 19-172-14 14 cm, 5½" 19-172-16 16 cm, 6½" | FROHN 19-174-12 12 cm, 4¾" 19-174-14 14 cm, 5½" 19-174-16 16 cm, 6½" |
| Rough, spiral end Spiralförmig gerieft Estriadura espiral Striures en spirale Zigrinatura spiraliforme | Round, cross serrated end Rund kreuzgerieft Estriadura redonda Rainures croisées Zigrinatura incrociata | Triangular serrated end Dreikant gerieft Estriadura triangular Striures triangulaires Zigrinatura traingolare |

ø 1,2 mm

¼

¼

¼

UCKERMANN
 19-178-16
 16 cm, 6¼"

Rough, spiral end
 Spiralförmig gerieft
 Estriadura espiral
 Striures en spirale
 Zigrinatura spiraliforme

ø 2,7 mm

¼

¼

¼

PELTESON
 19-194-23
 23 cm, 9"

Rough, spiral end
 Spiralförmig gerieft
 Estriadura espiral
 Striures en spirale
 Zigrinatura spiraliforme

FIEN
 19-196-28
 28 cm, 11"

Rough, spiral end
 Spiralförmig gerieft
 Estriadura espiral
 Striures en spirale
 Zigrinatura spiraliforme

| | | |
|--|--|--|
| ø 1,0 mm ¼ | ø 1,0 mm ¼ | ø 1,0 mm ¼ |
| LATHBURY 19-180-12 12 cm, 4¾" 19-180-14 14 cm, 5½" 19-180-16 16 cm, 6½" 19-180-18 18 cm, 7" 19-182-18 18 cm, 7" 19-184-18 18 cm, 7" | LATHBURY 19-182-12 12 cm, 4¾" 19-182-14 14 cm, 5½" 19-182-16 16 cm, 6½" | LATHBURY 19-184-12 12 cm, 4¾" 19-184-14 14 cm, 5½" 19-184-16 16 cm, 6½" |
| Rough, spiral end Spiralförmig gerieft Estriadura espiral Striures en spirale Zigrinatura spiraliforme | Round, cross serrated end Rund kreuzgerieft Estriadura redonda Rainures croisées Zigrinatura incrociata | Triangular serrated end Dreikant gerieft Estriadura triangular Striures triangulaires Zigrinatura traingolare |

ø 1,5 mm

¼

¼

¼

JABSON HORNE
 19-188-18
 18 cm, 7"

Serrated end
 Gerieft
 Estriadura
 Strié
 Zigrinatura

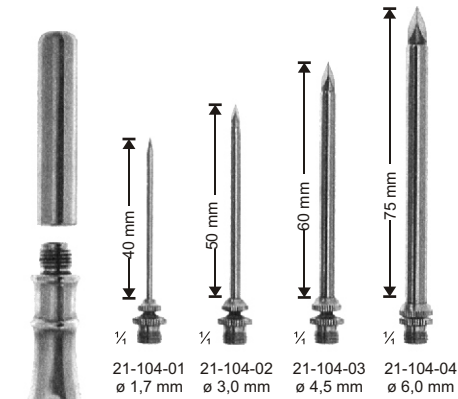

21-104-01 ø 1,7 mm
21-104-02 ø 3,0 mm
21-104-03 ø 4,5 mm
21-104-04 ø 6,0 mm

UNIVERSAL
21-104-01
21-104-04

Trocar with 4 tips
Trokar mit 4 Aufsätzen
Trócar con 4 puntas
Trocarts avec 4 embouts
Trequarti con 4 punte



STANDARD
21-108-03 ø 3 mm
21-108-04 ø 4 mm
21-108-05 ø 5 mm
21-108-06 ø 6 mm
12 cm, 4 3/4"

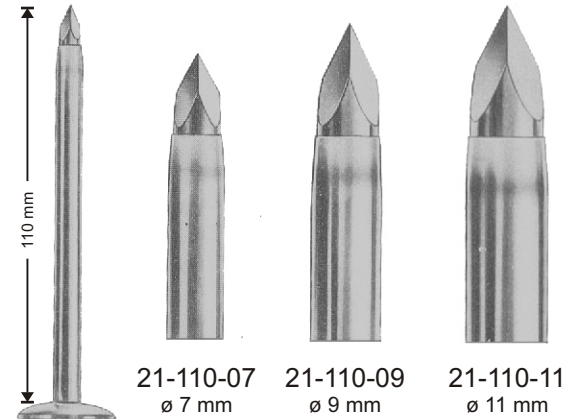

NELSON
21-110-07
21-110-11
21 cm, 8 1/2"

Trocars for hydrocele and abdominal puncture

Troakare für Hydrozele und Bauchstich

Trocares para hidrocele y punción abdominal

Trocarts pour hydrozèle et ponction abdominale

Trequarti per idrocele e puntura addominale

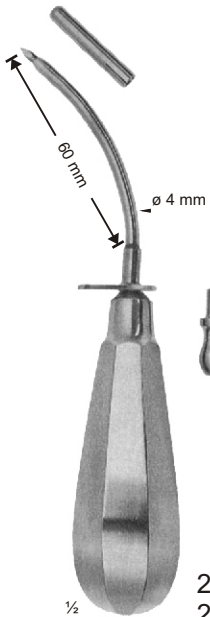

PIERCE
21-114-03 3mm
21-114-04 4mm
21-114-05 5mm
15 cm, 6"

Antrum trocar
Kieferhöhlentroker
Cánula para punción del seno maxilar
Trocarts pour le sinus maxillaire
Trequarti per puntura del seno mascellare

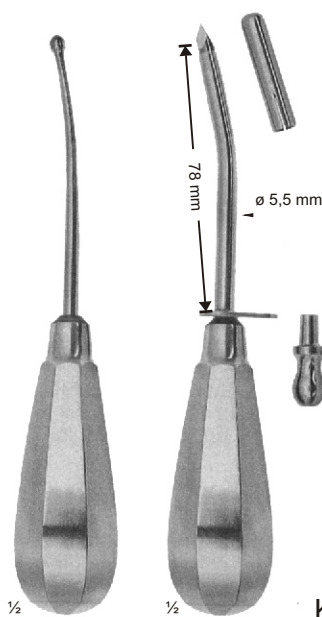

KRAUSE
21-118-15
15 cm, 6"

Antrum trocar
Kieferhöhlentroker
Cánula para punción del seno maxilar
Trocarts pour le sinus maxillaire
Trequarti per puntura del seno mascellare



DOUGLAS
21-120-16
16 cm, 6 1/4"

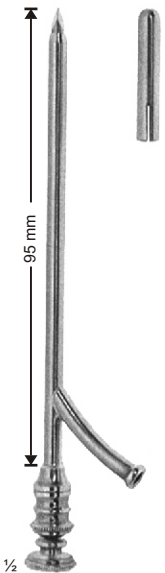

OCHSNER
21-128-01 ø 3,5mm
21-128-02 ø 4,5mm
21-128-03 ø 5,0mm
21-128-04 ø 5,5mm
21-128-05 ø 6,0mm
14 cm, 5 1/2"



LICHTWITZ
21-140-19
Ø 1,8 mm

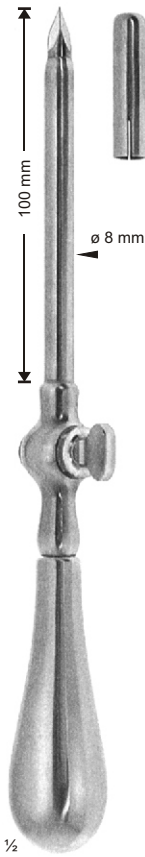

BUELAU
21-144-24
24 cm, 9½"

Empyema trocar
Empyema-Trokar
Trócar para puncción torácica
Trocarts pour ponction thoracique
Trequarti per empiema

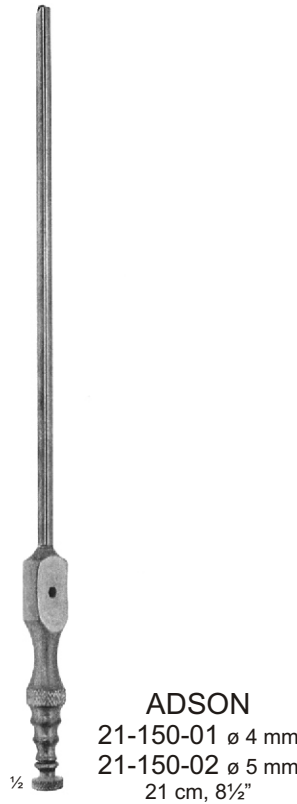

ADSON
21-150-01 Ø 4 mm
21-150-02 Ø 5 mm
21 cm, 8½"

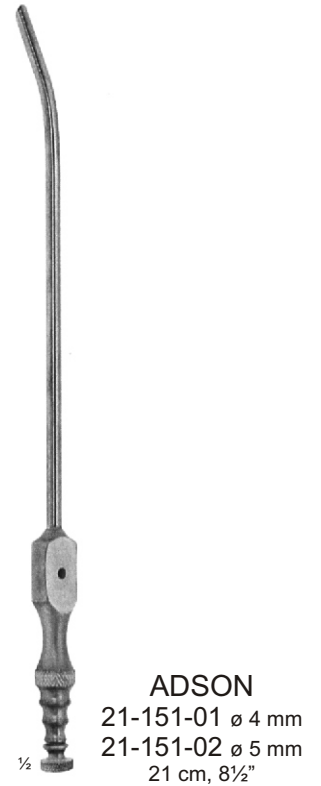

ADSON
21-151-01 Ø 4 mm
21-151-02 Ø 5 mm
21 cm, 8½"



FRAZIER
21-152-01 Ø 2,0 mm
21-152-02 Ø 2,3 mm
21-152-03 Ø 2,7 mm
21-152-04 Ø 3,3 mm
21-152-05 Ø 3,7 mm
20 cm, 8"



FRAZIER
21-155-01 Ø 2,0 mm
21-155-02 Ø 2,3 mm
21-155-03 Ø 2,7 mm
21-155-04 Ø 3,3 mm
21-155-05 Ø 3,7 mm
21-155-06 Ø 4,0 mm
21-155-07 Ø 5,0 mm
19 cm, 7½"

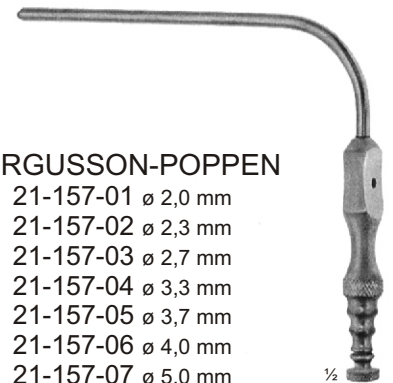

FERGUSSON-POP PEN
21-157-01 Ø 2,0 mm
21-157-02 Ø 2,3 mm
21-157-03 Ø 2,7 mm
21-157-04 Ø 3,3 mm
21-157-05 Ø 3,7 mm
21-157-06 Ø 4,0 mm
21-157-07 Ø 5,0 mm
13 cm, 5"



ø 2,3 mm

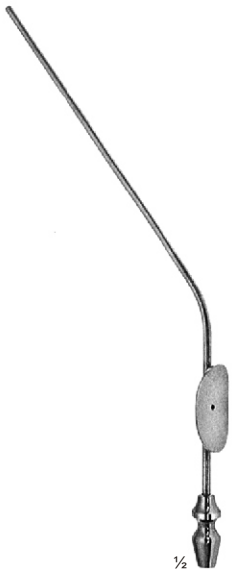

BARNES
21-159-16
16 cm, 6¼"

Suction cannula with LUER hub and finger cut-off

Saugkennüle mit LUER-Bohrung und Unterbrecher

Cánula para aspiración con cono LEUR y interruptor

Canule d'aspiration avec cône LUER et interrupteur à doigt

Cannula per aspirazione con perforazione LUER e interruttore

ø 3,0 x 6,5 mm



21-161-15
15,5 cm, 6"

Nasal suction tube with LUER hub

Nasensaugrohr mit LUER - Bohrung

Tubo nasal para aspiración con cono de LUER

Canule d'aspiration nasale avec cône LUER

Tubo per aspirazione nasale con perforazione LUER



21-163-01 ø 4,5 mm
21-167-02 ø 5,5 mm
18,5 cm, 7¼"

Nasal suction tube with LUER hub

Nasensaugrohre mit LUER - Bohrung

Tubos nasal para aspiración con cono de LUER

Canule d'aspiration nasale avec cône LUER

Tubo per aspirazione nasale con perforazione LUER

ø 10 mm



POOLE
03-170-22
22 cm, 8¾"

With outer tube to be screwed off

Mit abschraubbarem Außenrohr

Con tubo exterior desentoscable

Avec canule extérieure démontable

Con tubo esterno svitabile

ø 5,5 mm



BABY-POOLE
03-171-20
20 cm, 8"

ø 8 mm



POOLE
03-173-22
22 cm, 8¾"



Ø 2,6 mm

Ø 3,3 mm



21-180-01
Fig.1

21-180-02
Fig.2

Suction basket only

Saugkopf allein
 Cabezal para aspiración, suelto
 Embout d'aspiration seul
 Solo cestello aspirazione
 21-180-05

Ø 10 mm

Ø 4,8 mm



¼

21-181-03
Fig.3



¼

21-181-04
Fig.4



YANKAUER
 21-180-01
 21-180-00
 27 cm, 11"

Set , Setz , Juego , Jeu , Serie



21-182-01
Ø1,5 cm

21-182-02
Ø2 cm

21-182-03
Ø2,5 cm

½ 21-182-04
Ø3,5 cm



21-183-01
Ø1,5 cm

21-183-02
Ø2 cm

21-183-03
Ø2,5 cm

½ 21-183-04
Ø3,5 cm

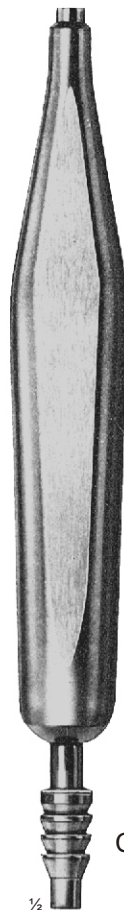

COUPLAND
 21-182-01
 21-182-00
 17 cm, 6¾"

Set , Setz , Juego , Jeu , Serie



NUBBER
 21-184-21
 21 cm, 8½"

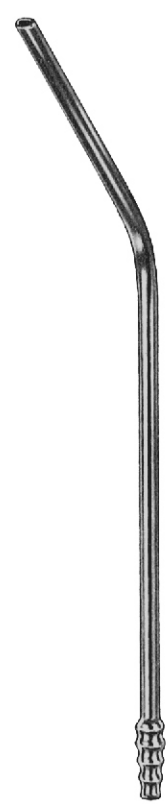

NUBBER
 21-185-21
 21 cm, 8½"



½

BYRD
 21-186-01
 21-186-03
 17 cm, 6¾"

21-186-01
Ø1,5 cm

21-186-02
Ø2,5 cm

21-186-03
Ø3,5 cm



Suction Tubes

Saugrohre

Tubos para aspiración

Canules d'aspiration

Tubi aspirazione



021

Ø7mm



¼

COLLEY
21-188-30
30 cm, 12"

Ø10mm



¼

COLLEY
21-188-31
31cm, 12½"

Ø8mm



¼

COLLEY
21-188-33
33cm, 13¼"

Ø8mm

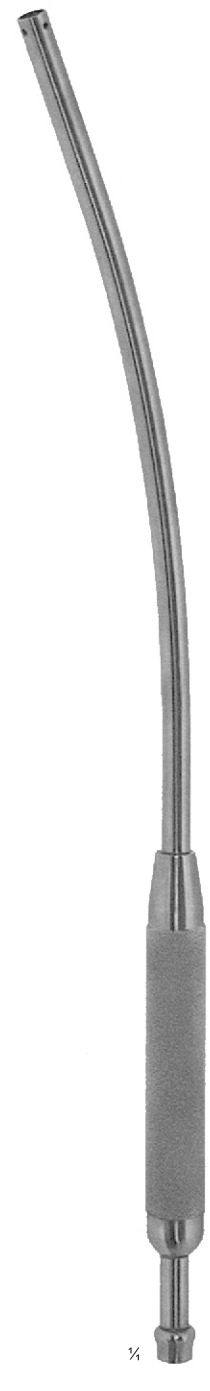

¼

COLLEY
21-188-35
35cm, 14"



03-128-01

Suction basket only

Saugkopf allein

Cabezal para aspiración, suelto

Embout d'aspiration seul

Solo cestello aspirazione

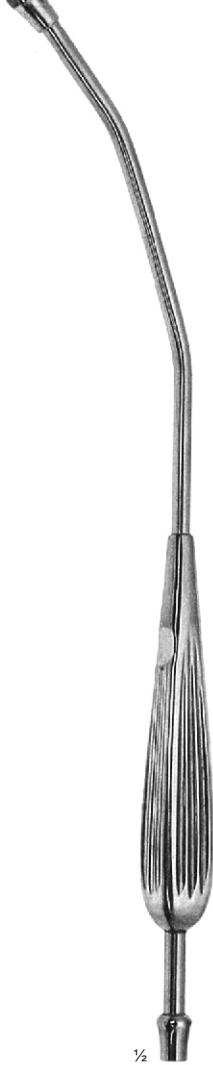

½

YANKAUER

03-126-27

27 cm, 11"

03-126-01

Suction basket only

Saugkopf allein

Cabezal para aspiración, suelto

Embout d'aspiration seul

Solo cestello aspirazione



½

DE BAKEY

03-128-28

28 cm, 11"

with lateral slots
mit seitlichen Schlitz
con ranuras laterales
avec tube cannelé
con scanalature laterali

03-127-01

Suction basket only

Saugkopf allein

Cabezal para aspiración, suelto

Embout d'aspiration seul

Solo cestello aspirazione

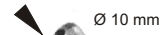

½

YANKAUER

03-129-32

32 cm, 12½"

with stopcock and tube to be screwed off

mit Absperrventil und
abschraubbarem Rohr

con interruptor y tubo
desenroscable

avec robinet et canule
extérieure démontable

con interruttore e tubo
svitabile

Ø 6 mm

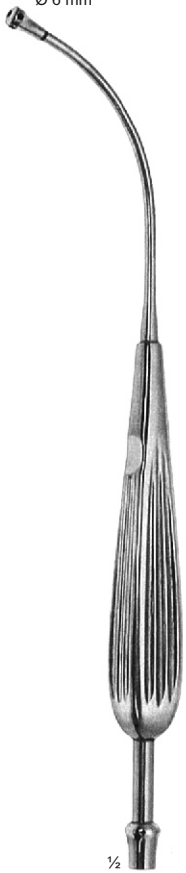

½

ANDREW-PYNCHON

03-124-23

23 cm, 9"



Guide Needles
 Führungsnadeln
 Aguja de guía
 Aiguilles guides
 Aghi per introduzione

Syringes
 Spritzen
 Jeringas
 Seringues
 Siringhe

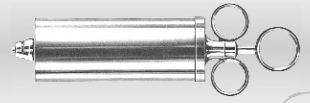

021

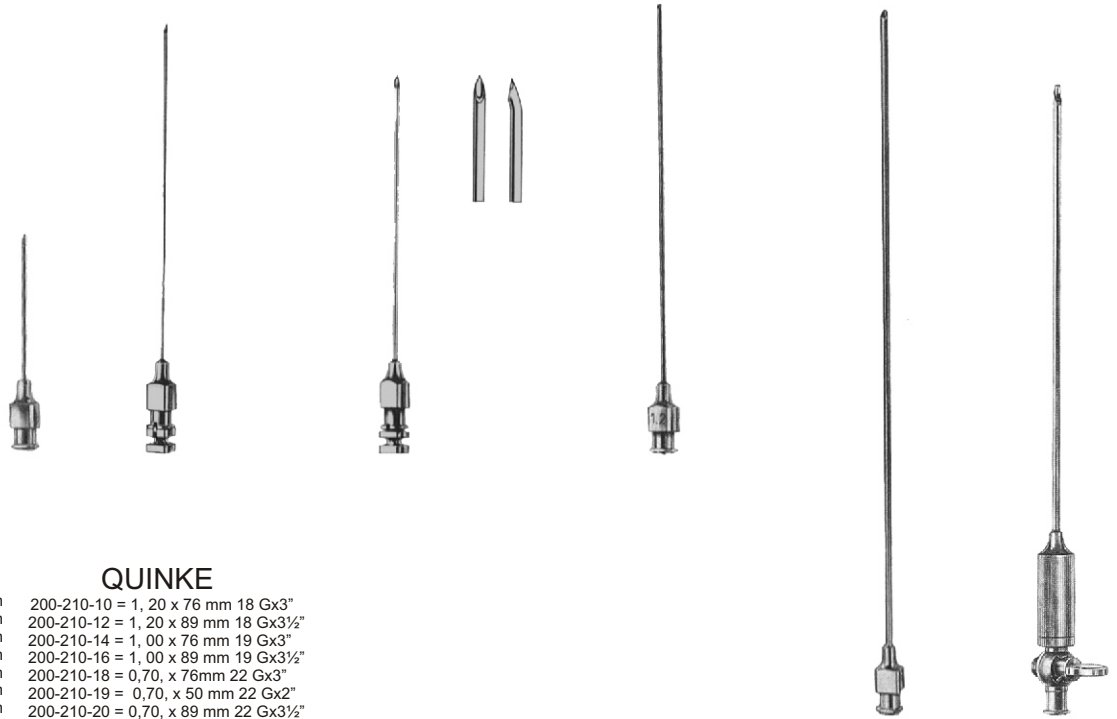
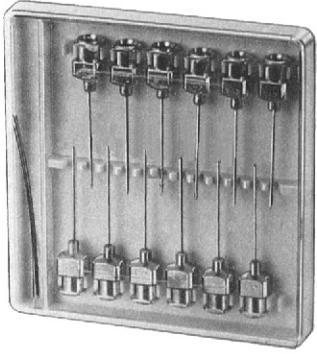

LUER-LOCK
 21-200-01
 21-200-20

QUINKE

| | | | |
|--------|-----------|----------------|-------------------------------------|
| Fig 1 | 21-200-01 | ø 0,90 x 38 mm | 200-210-10 = 1,20 x 76 mm 18 Gx3" |
| Fig 2 | 21-200-02 | ø 0,80 x 32 mm | 200-210-12 = 1,20 x 89 mm 18 Gx3½" |
| Fig 12 | 21-200-12 | ø 0,70 x 32 mm | 200-210-14 = 1,00 x 76 mm 19 Gx3" |
| Fig 14 | 21-200-14 | ø 0,65 x 28 mm | 200-210-16 = 1,00 x 89 mm 19 Gx3½" |
| Fig 16 | 21-200-16 | ø 0,60 x 25 mm | 200-210-18 = 0,70, x 76mm 22 Gx3" |
| Fig 18 | 21-200-18 | ø 0,50 x 28 mm | 200-210-19 = 0,70, x 50 mm 22 Gx2" |
| Fig 20 | 21-200-20 | ø 0,45 x 20 mm | 200-210-20 = 0,70, x 89 mm 22 Gx3½" |





Biopsy Needles
 Biopsiekanülen
 Aguja para biopsia
 Aiguilles à biopsie
 Aghi per biopsia

Pneumoperitoneum Needles
 Peritoneal-Pneu-Kanülen
 Aguja para el neumoperitoneo
 Aiguilles pour le pneumopéritoine
 Aghi per il pneumo-peritoneo

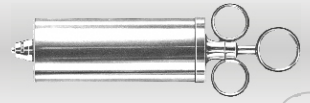

021



21-248-01



21-248-02



21-248-03



21-248-04



21-248-05



21-252-01

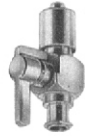

21-252-02



21-252-03

| | ∅ | Charr./Fr. |
|-----------|------|------------|
| 21-250-03 | 3 mm | 14 |
| 21-250-04 | 4 mm | 16 |
| 21-250-05 | 5 mm | 18 |
| 21-250-06 | 6 mm | 20/22 |
| 21-250-07 | 7 mm | 24/26 |
| 21-250-08 | 8 mm | 28/30 |
| 21-250-09 | 9 mm | 32/34 |
| 21-250-10 | 10mm | 36 |
| 21-250-11 | 11mm | 38 |
| 21-250-12 | 12mm | 40/42 |
| 21-250-13 | 13mm | 44/46 |



REDON

- 21-261-01 ∅ 2,5 mm
 - 21-261-02 ∅ 3,5 mm
 - 21-261-03 ∅ 4,0 mm
 - 21-261-04 ∅ 4,5 mm
 - 21-261-05 ∅ 5,5 mm
 - 21-261-06 ∅ 6,0 mm
- 19,5 cm, 7¾"

wiht Knife-edge
 mit messerschneide
 con filo de cuchillo
 avec pointe effilée
 con bordo tagliente

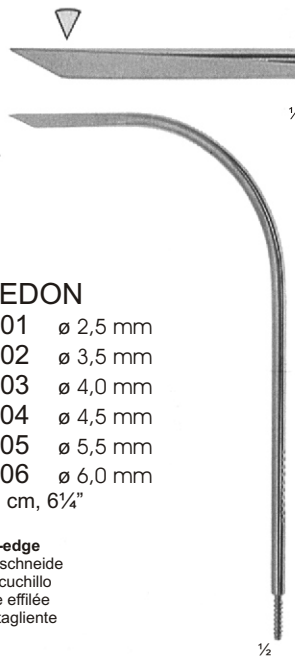

REDON

- 21-263-01 ∅ 2,5 mm
 - 21-263-02 ∅ 3,5 mm
 - 21-263-03 ∅ 4,0 mm
 - 21-263-04 ∅ 4,5 mm
 - 21-263-05 ∅ 5,5 mm
 - 21-263-06 ∅ 6,0 mm
- 16 cm, 6¼"

wiht Knife-edge
 mit messerschneide
 con filo de cuchillo
 avec pointe effilée
 con bordo tagliente



REDON

- 21-265-01 ∅ 2,5 mm
 - 21-265-02 ∅ 3,5 mm
 - 21-265-03 ∅ 4,0 mm
 - 21-265-04 ∅ 4,5 mm
 - 21-265-05 ∅ 5,5 mm
 - 21-265-06 ∅ 6,0 mm
- 19,5 cm, 7¾"

With lancet tip
 Mit Lanzettenspitze
 con punta lanceolar
 avec pointe lancéolaire
 con lancetta

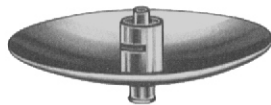
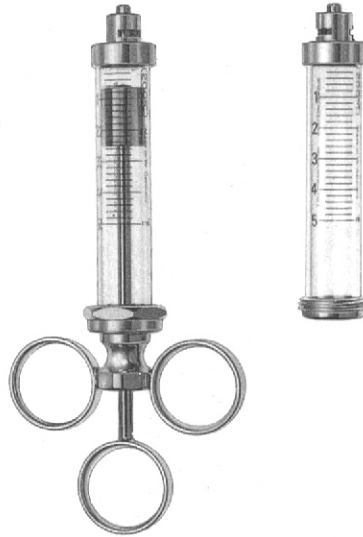
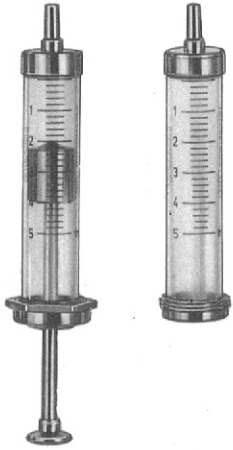
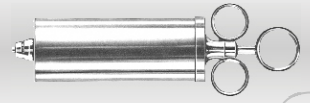

21-250-02



21-250-03



21-250-04



21-260-02



21-260-03



21-260-01