

023

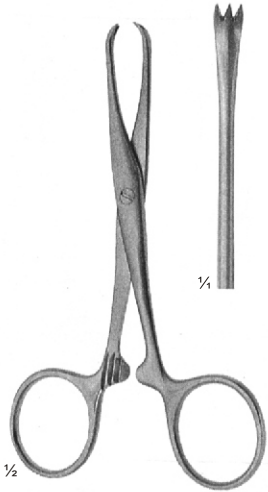

Intestines, Stomach, Rectum
Darm, Magen, Mastdarm
Intestino, Estómago, Recto
Intestins, Estomac, Rectum
Intestino, Stomaco, Retto

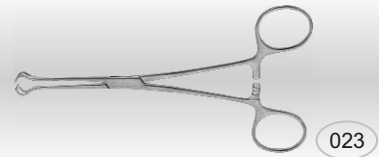

CHAPUT
 23-106-13
 13 cm, 5"

2x3 Teeth
 2x3 Zähne
 2x3 Dientes
 2x3 Dents
 2x3 Denti



BABY-ALLIS
 23-108-12
 23-108-14

4x5 Teeth
 4x5 Zähne
 4x5 Dientes
 4x5 Dents
 4x5 Denti

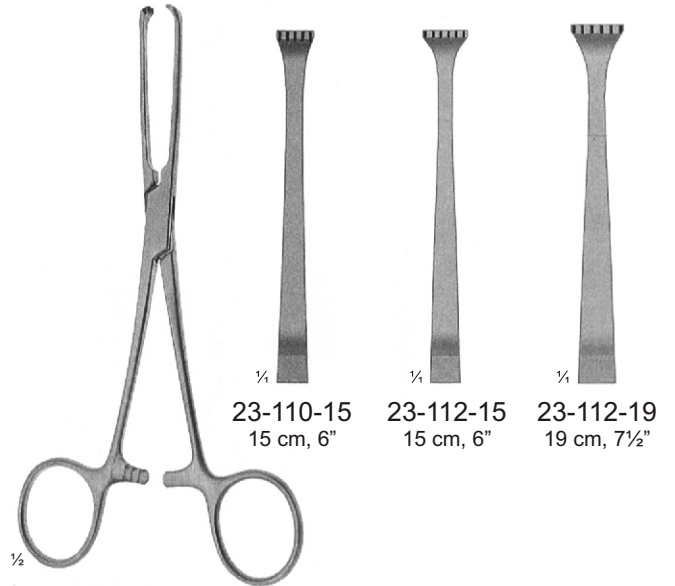

ALLIS
 23-110-15
 23-112-19

4x5 Teeth
 4x5 Zähne
 4x5 Dientes
 4x5 Dents
 4x5 Denti

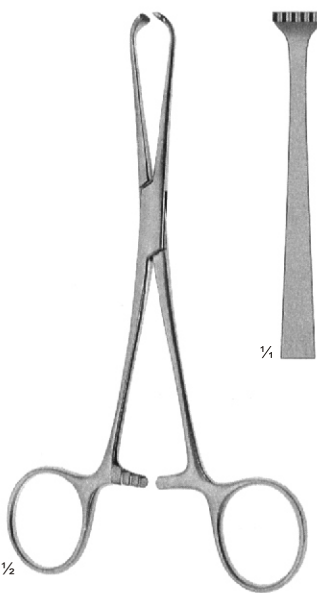

BOYS-ALLIS
 23-114-15
 15 cm, 6"

4x5 Teeth
 4x5 Zähne
 4x5 Dientes
 4x5 Dents
 4x5 Denti

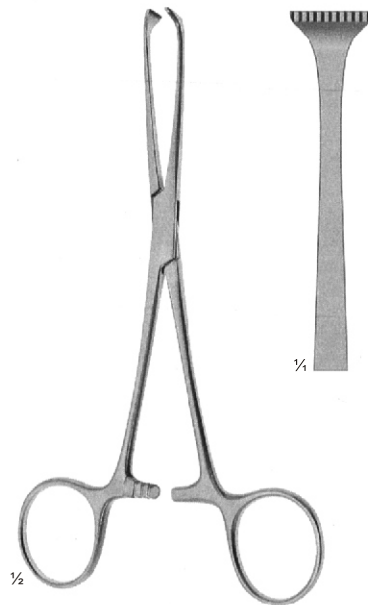

ADAIR-ALLIS
 23-116-15
 15,5 cm, 6"

10x11 Teeth
 10x11 Zähne
 10x11 Dientes
 10x11 Dents
 10x11 Denti

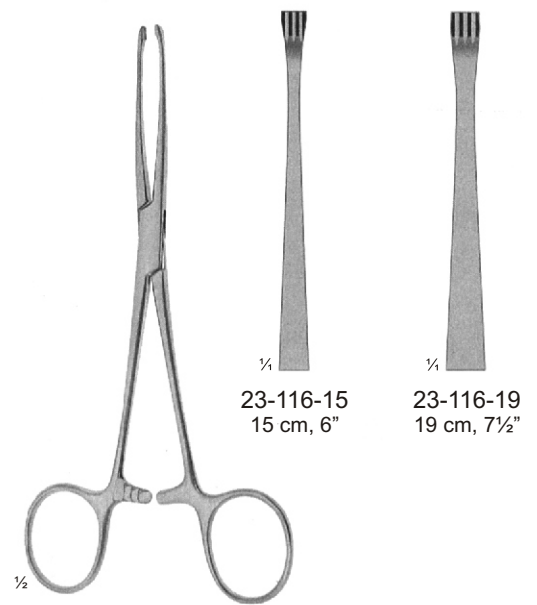

JUDD-ALLIS
 23-118-15
 23-118-19

3x4 Teeth
 3x4 Zähne
 3x4 Dientes
 3x4 Dents
 3x4 Denti

Intestinal and Tissue Grasping Forceps

Darm- und Gewebefaßzangen
 Pinzas intestinales y para tejidos
 Pinces à préhension de l'intestin
 Pinze da presa per intestino e tessuti

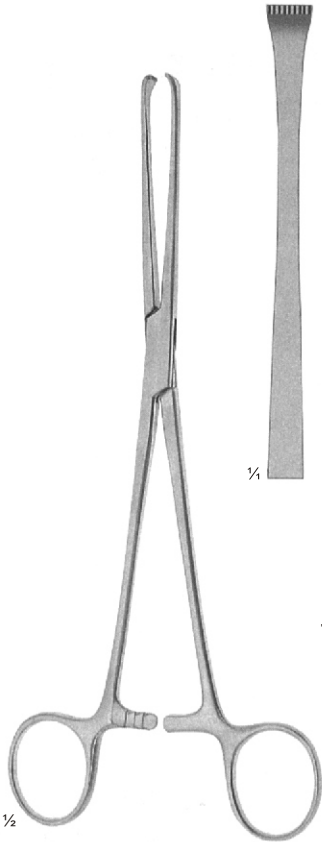
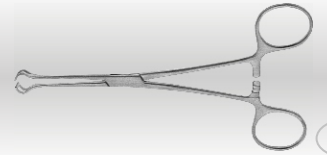

THOMS-ALLIS
 23-120-20
 20 cm, 8"

8x9 Teeth
 8x9 Zähne
 8x9 Dientes
 8x9 Dents
 8x9 Denti



ALLIS
 23-130-23
 23-130-25

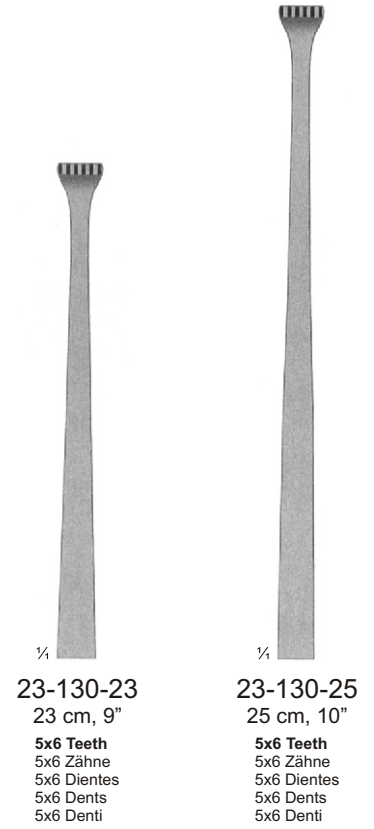

23-130-23
 23 cm, 9"

5x6 Teeth
 5x6 Zähne
 5x6 Dientes
 5x6 Dents
 5x6 Denti

23-130-25
 25 cm, 10"

5x6 Teeth
 5x6 Zähne
 5x6 Dientes
 5x6 Dents
 5x6 Denti

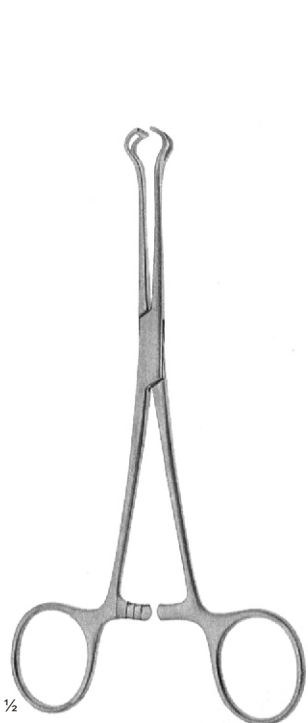

BABCOCK
 23-138-14
 23-138-24

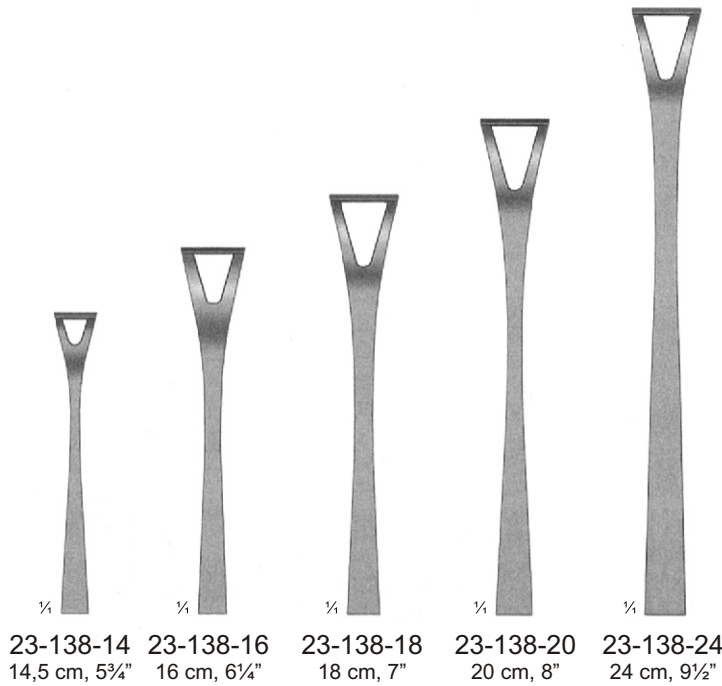

23-138-14
 14,5 cm, 5 3/4"

23-138-16
 16 cm, 6 1/4"

23-138-18
 18 cm, 7"

23-138-20
 20 cm, 8"

23-138-24
 24 cm, 9 1/2"

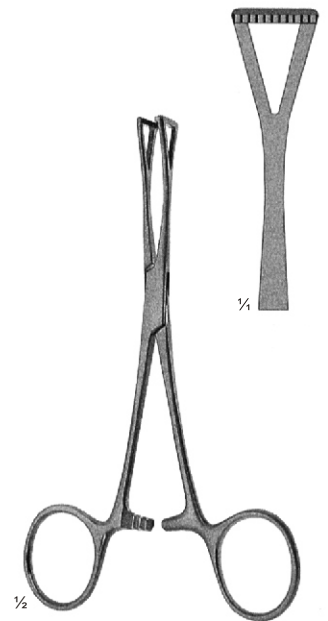

COLLIN
 23-144-14
 14 cm, 5 1/2"

Intestinal and Tissue Grasping Forceps

Darm- und Gewebefaßzangen
 Pinzas intestinales y para tejidos
 Pincès à préhension de l'intestin
 Pinze da presa per intestino e tessuti

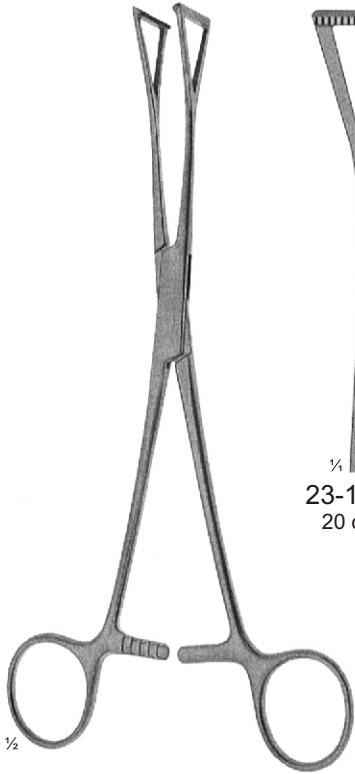
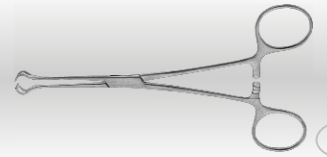

¼
 23-150-20
 20 cm, 8"

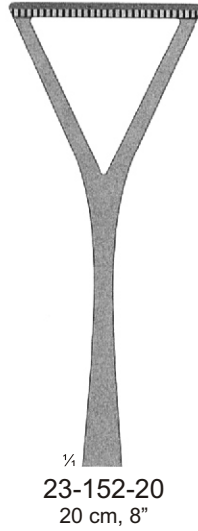

¼
 23-152-20
 20 cm, 8"

DUVAL
 23-150-20
 23-152-20

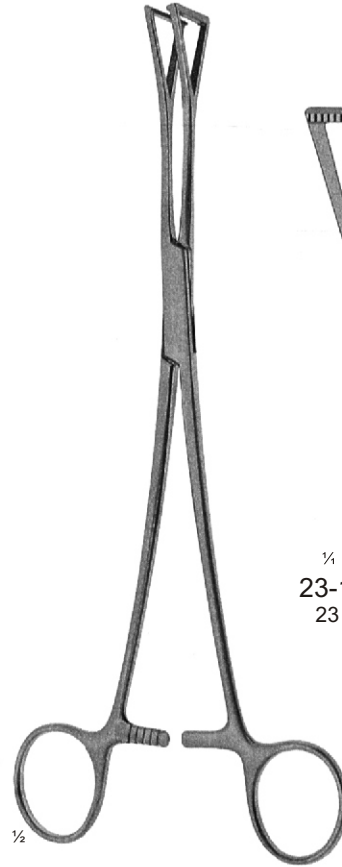

¼
 23-154-23
 23 cm, 9"

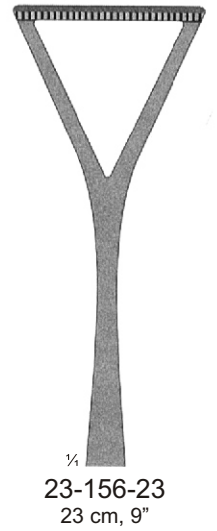

¼
 23-156-23
 23 cm, 9"

DUVAL
 23-154-23
 23-156-23

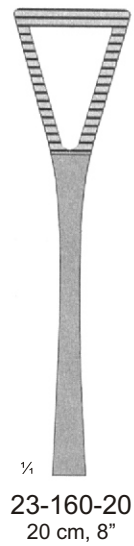

¼
 23-160-20
 20 cm, 8"

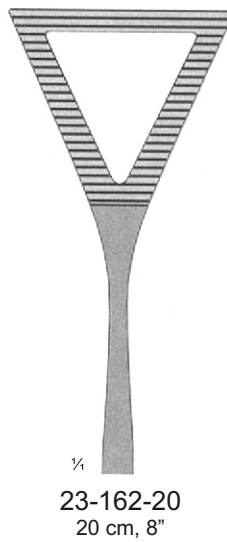

¼
 23-162-20
 20 cm, 8"

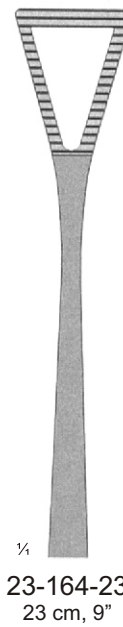

¼
 23-164-23
 23 cm, 9"



¼
 23-166-23
 23 cm, 9"

DUVAL
 23-160-20
 23-166-23

Intestinal and Tissue Grasping Forceps

Darm- und Gewebefaßzangen
 Pinzas intestinales y para tejidos
 Pinces à préhension de l'intestin
 Pinze da presa per intestino e tessuti

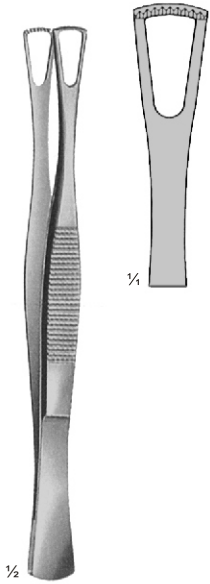
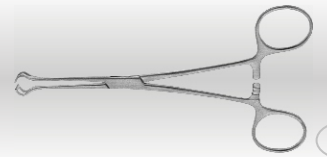

DUVAL
 23-170-14
 14,5 cm, 5½"

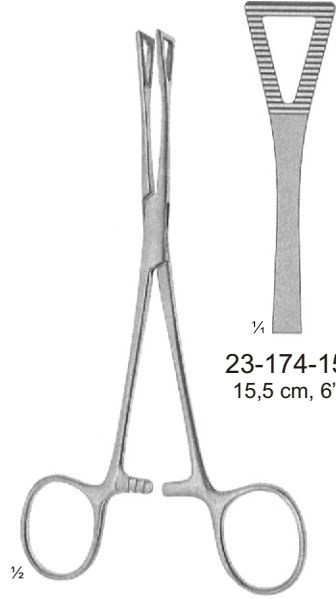

PENNINGTON
 23-174-15
 23-174-20

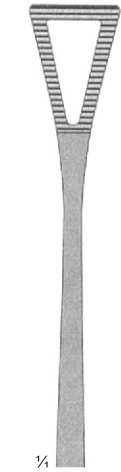

23-174-20
 20 cm, 8"

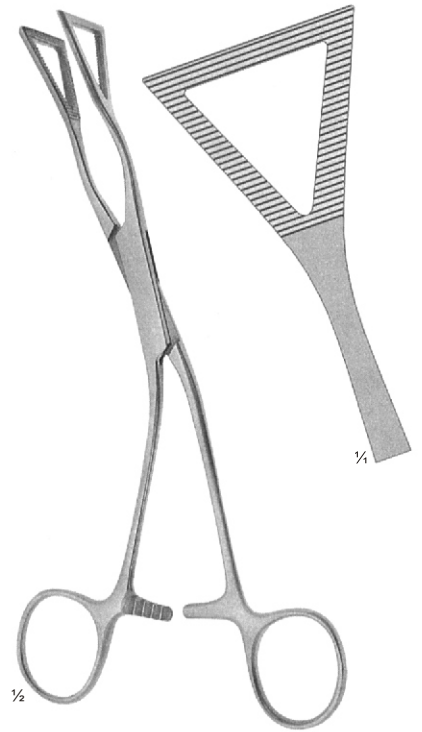

LOVELACE
 23-177-20
 20 cm, 8"

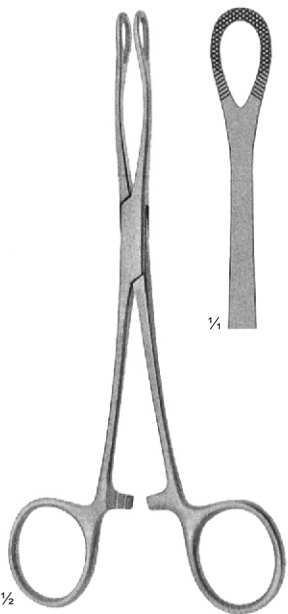

WILLIAMS
 23-180-16
 16 mm, 6¼"

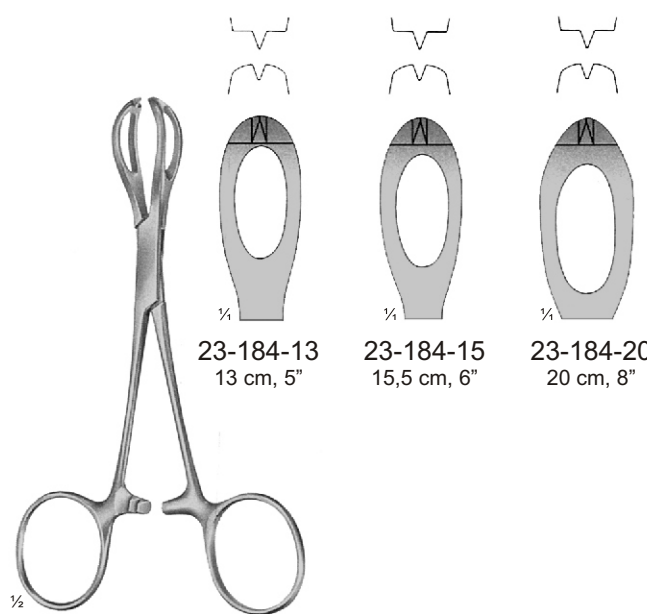

LANE
 23-184-13
 23-184-20

23-184-13
 13 cm, 5"

23-184-15
 15,5 cm, 6"

23-184-20
 20 cm, 8"

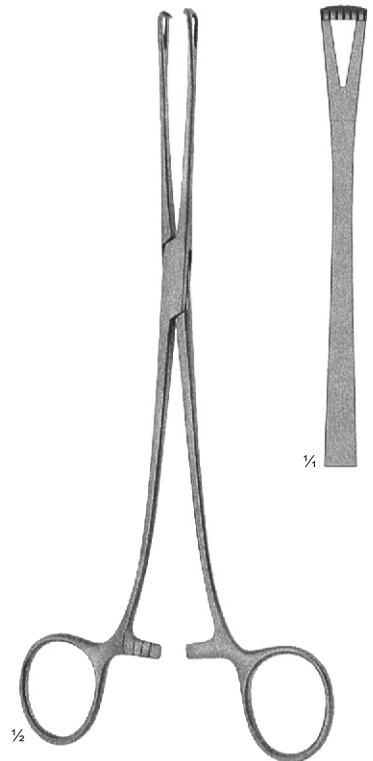

LOCKWOOD
 23-188-20
 20 cm, 8"

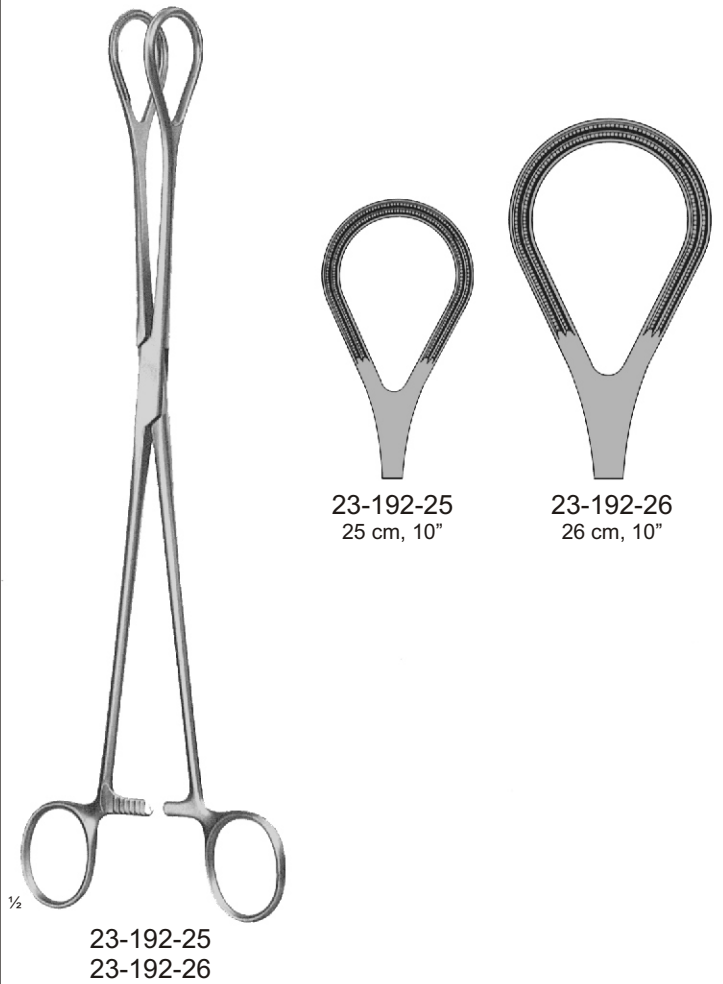
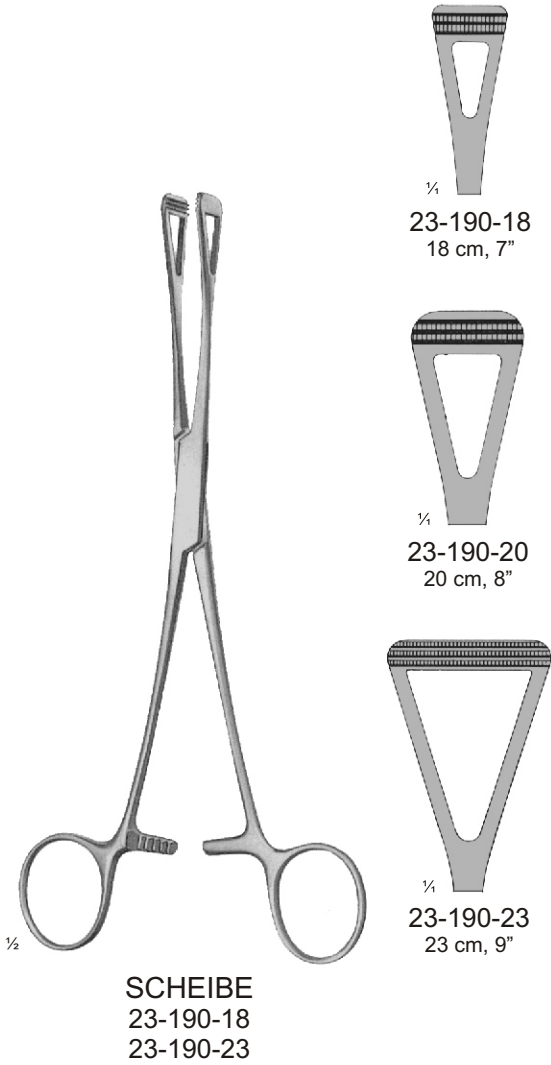

Intestinal and Tissue Grasping Forceps

Darm- und Gewebefaßzangen
 Pinzas intestinales y para tejidos
 Pincès à préhension de l'intestin
 Pinze da presa per intestino e tessuti

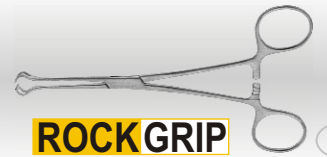

ROCKGRIP

023

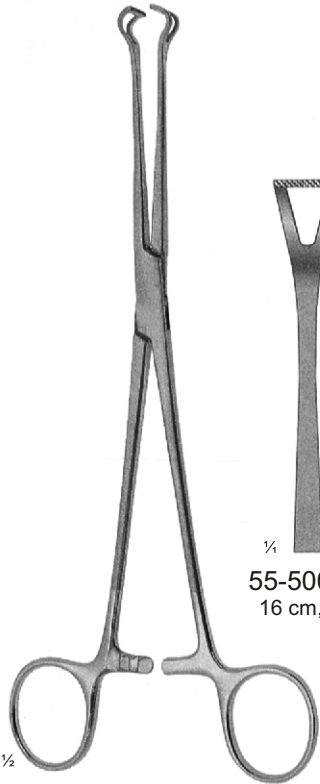

55-500-16
16 cm, 6¼"

55-500-18
18 cm, 7"

55-500-20
20 cm, 8"

55-500-23
23 cm, 8"

BABCOCK
55-500-16
55-500-23

With tungsten carbide inserts
 Mit Hartmetalleinlagen
 Con bocas de carburo tungsteno
 Avec mors en tungstène
 Con morsi in carburo di tungsteno

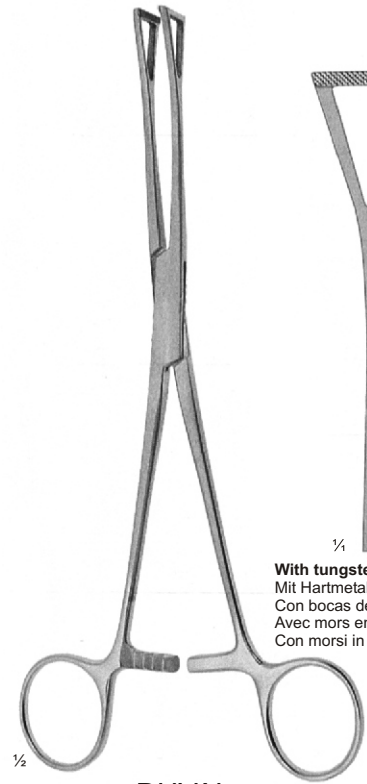

DUVAL
55-502-20
20 cm, 8"

With tungsten carbide inserts
 Mit Hartmetalleinlagen
 Con bocas de carburo tungsteno
 Avec mors en tungstène
 Con morsi in carburo di tungsteno

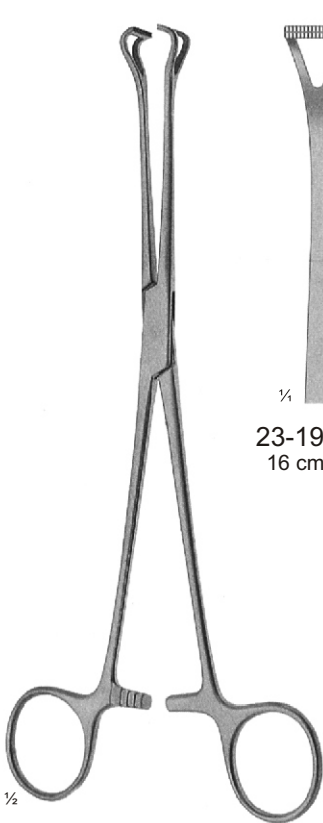

23-192-16
16 cm, 6¼"

23-192-20
20 cm, 8"

23-192-23
23cm, 9"



BABCOCK
23-192-16
23-192-23

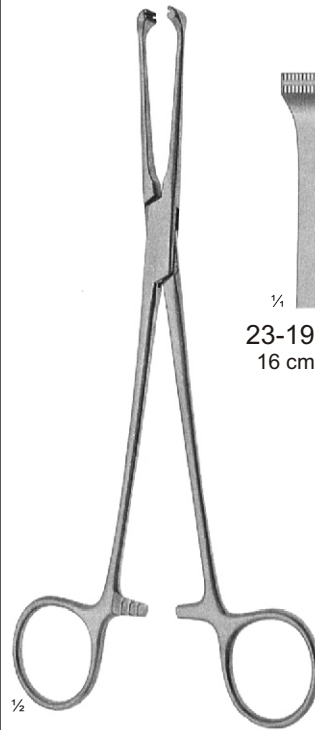

23-196-16
16 cm, 6¼"

23-196-20
20 cm, 8"

23-196-25
25 cm, 10"

23-196-30
30 cm, 12"



ALLIS
23-196-16
23-196-30

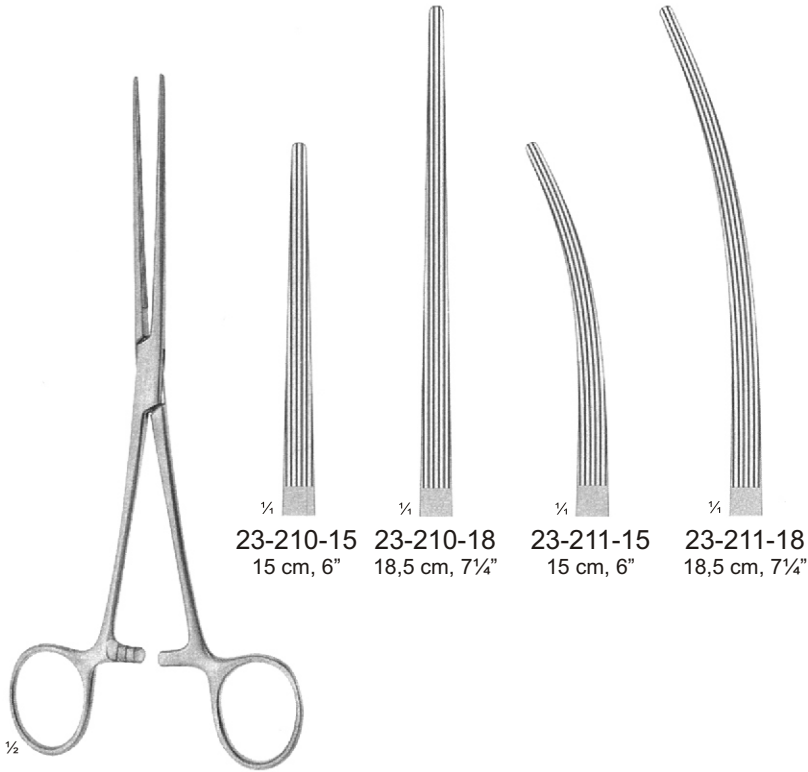
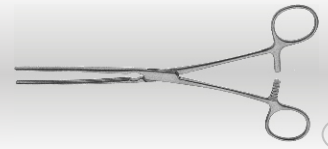

BAINBRIDGE
 23-210-15
 23-211-18

23-210-15
 15 cm, 6"

23-210-18
 18,5 cm, 7¼"

23-211-15
 15 cm, 6"

23-211-18
 18,5 cm, 7¼"

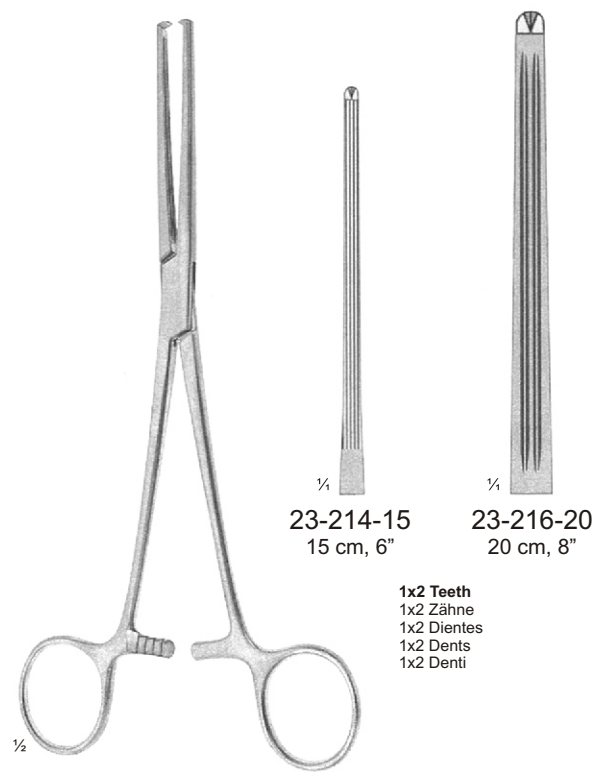

ALLEN
 23-214-15
 23-216-20

23-214-15
 15 cm, 6"

23-216-20
 20 cm, 8"

1x2 Teeth
 1x2 Zähne
 1x2 Dientes
 1x2 Dents
 1x2 Denti

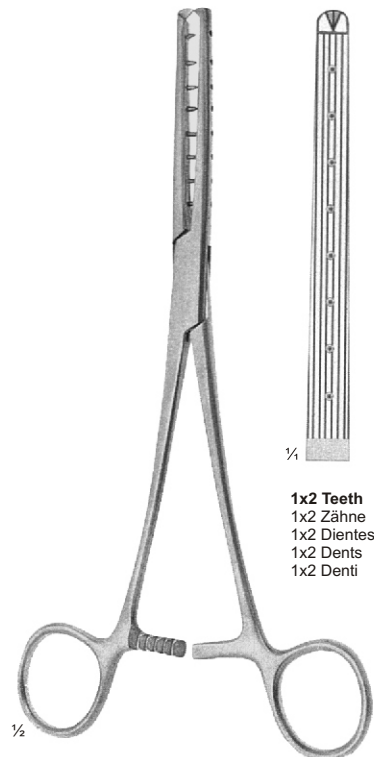

REDO
 23-220-20
 20 cm, 8"

1x2 Teeth
 1x2 Zähne
 1x2 Dientes
 1x2 Dents
 1x2 Denti

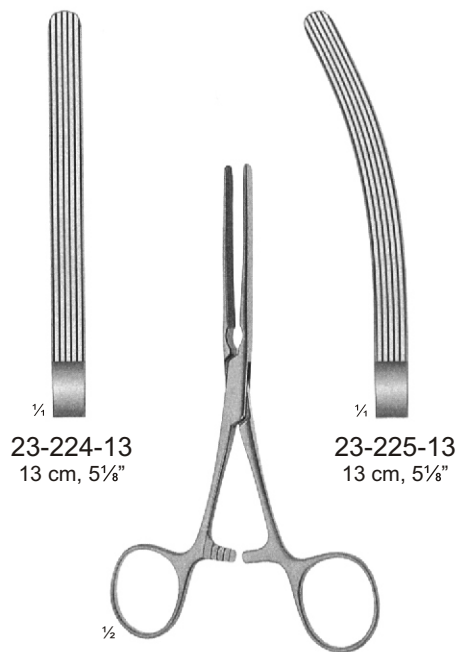

BABY-KOCHER
 23-224-13
 23-225-13

Soft elastic
 Weich federnd
 elásticas (suave)
 souples
 leggermente elastica

23-224-13
 13 cm, 5½"

23-225-13
 13 cm, 5½"

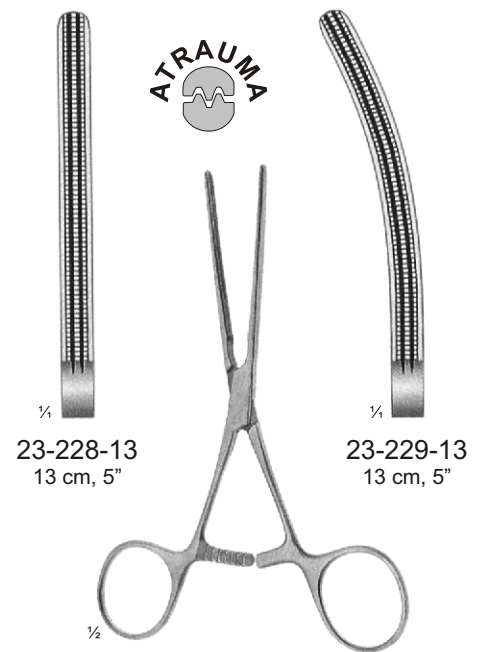

BABY-KOCHER
 23-228-13
 23-229-13

Soft elastic
 Weich federnd
 elásticas (suave)
 souples
 leggermente elastica

23-228-13
 13 cm, 5"

23-229-13
 13 cm, 5"



Intestinal Clamp Forceps
Darmklemmen
Pinzas-clamps intestinales
Pincas-clamps intestinales
Pinze intestinali

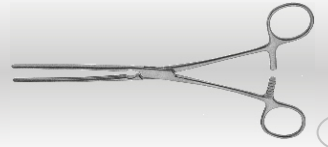

023

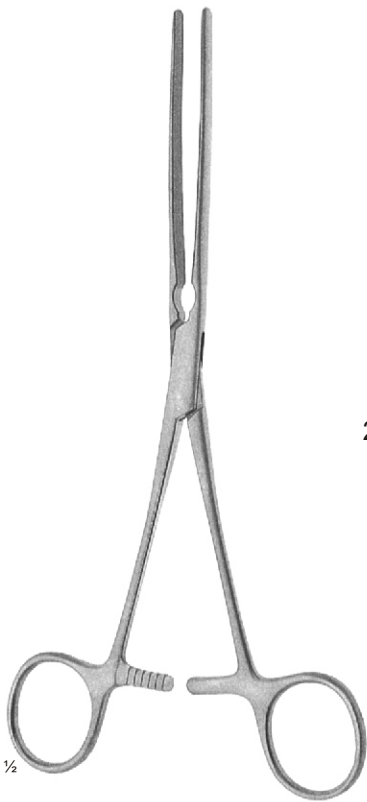

1/2

KOCHER
23-232-21
23-233-28



1/4

23-232-21
21 cm, 8 1/2"



1/4

23-232-23
23 cm, 9"



1/4

23-232-28
28 cm, 11"



1/4

23-233-21
21 cm, 8 1/2"



1/4

23-233-23
23 cm, 9"

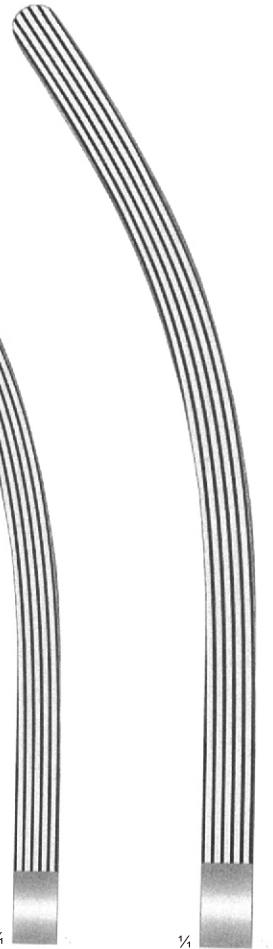

1/4

23-233-28
28 cm, 11"

Soft elastic
Weich federnd
elásticas (suave)
souples
leggermente elastica



Intestinal Clamp Forceps
 Darmklemmen
 Pinzas-clamps intestinales
 Pincas-clamps intestinales
 Pinze intestinali

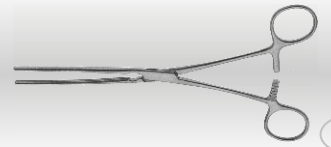

041

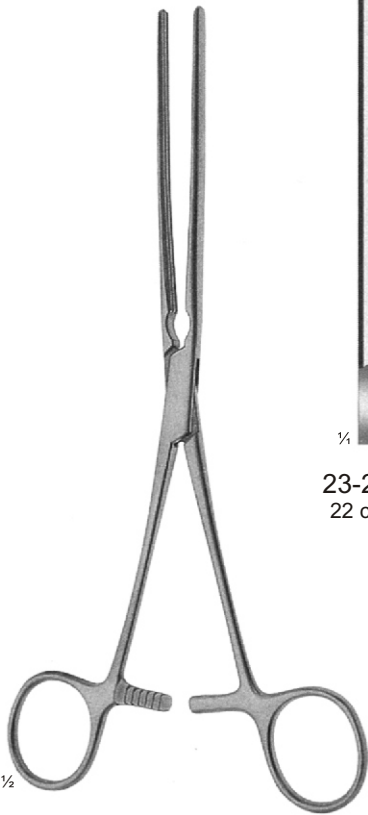

1/2

KOCHER
 23-236-22
 23-237-28

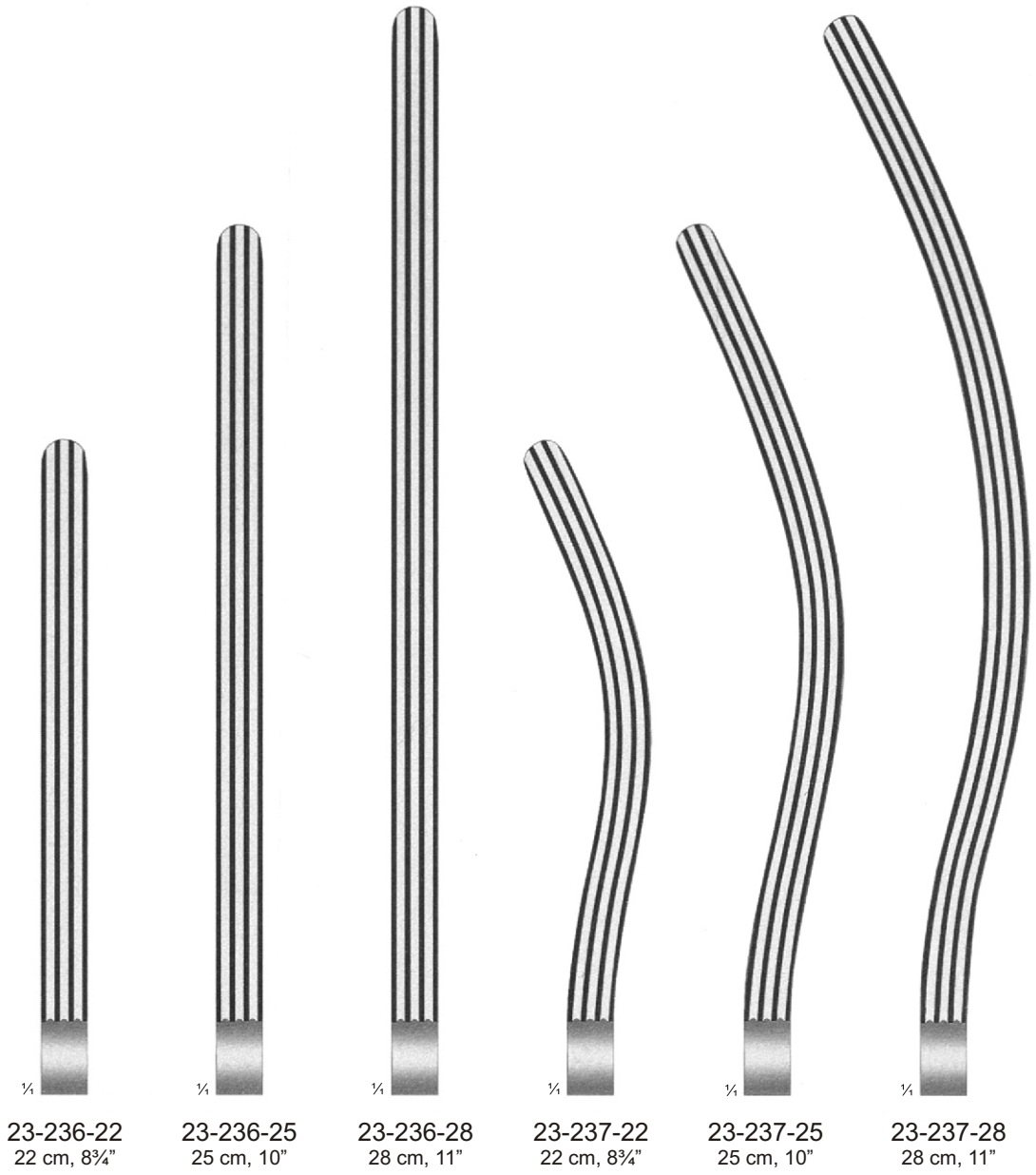

Soft elastic
 Weich federnd
 elásticas (suave)
 souples
 leggermente elastica



Intestinal Clamp Forceps
 Darmklemmen
 Pinzas-clamps intestinales
 Pincers-clamps intestinales
 Pinze intestinali

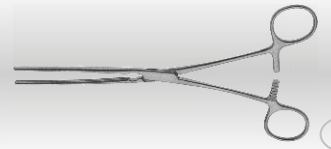

023



1/2

DOYEN
 23-244-13
 23-245-23

Soft elastic
 Weich federnd
 elásticas (suave)
 souples
 leggermente elastica



23-244-13
 13 cm, 5"



23-244-16
 16 cm, 6 1/4"



23-244-18
 18 cm, 7"



23-244-21
 21 cm, 8 1/4"



23-244-23
 23 cm, 9"



23-245-13
 13 cm, 5"



23-245-16
 16 cm, 6 1/4"



23-245-18
 18 cm, 5"



23-245-21
 21 cm, 8 1/4"

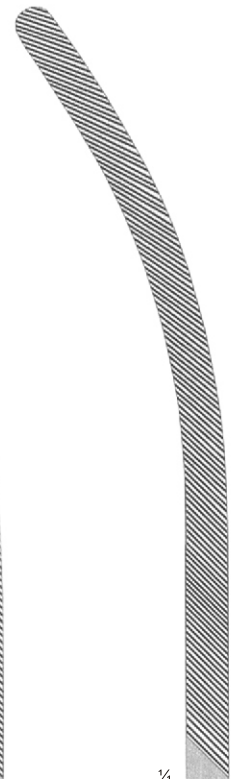

23-245-23
 23 cm, 9"



Intestinal Clamp Forceps
 Darmklemmen
 Pinzas-clamps intestinales
 Pincers-clamps intestinales
 Pinze intestinali

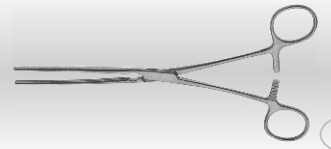

023



1/2

DOYEN
 23-244-13
 23-245-23

Soft elastic
 Weich federnd
 elásticas (suave)
 souples
 leggermente elastica



23-244-13
 13 cm, 5"



23-244-16
 16 cm, 6 1/4"



23-244-18
 18 cm, 7"



23-244-21
 21 cm, 8 1/4"



23-244-23
 23 cm, 9"



23-245-13
 13 cm, 5"



23-245-16
 16 cm, 6 1/4"



23-245-18
 18 cm, 5"



23-245-21
 21 cm, 8 1/4"



23-245-23
 23 cm, 9"

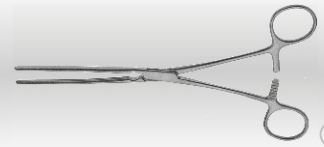

With non-traumatic serration
 Mit atraumatischer Riefung
 Con bocas atraumáticas
 Avec mors atraumatiques
 Con presa atraumatica



1/2

DOYEN
 23-248-13
 23-249-23

Soft elastic
 Weich federnd
 elásticas (suave)
 souples
 leggermente elastica

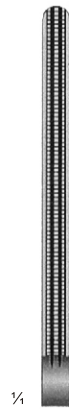

23-248-13
 13 cm, 5"



23-248-16
 16 cm, 6 1/4"

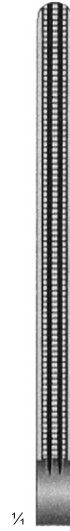

23-248-18
 18 cm, 7"

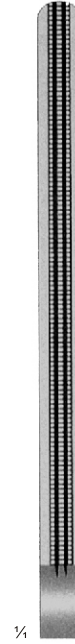

23-248-21
 21 cm, 8 1/4"

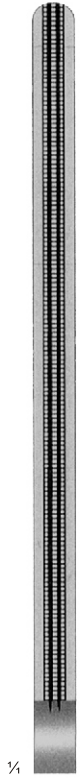

23-248-23
 23 cm, 9"



23-249-13
 13cm, 5"



23-249-16
 16cm, 6 1/4"



23-249-18
 18cm, 7"

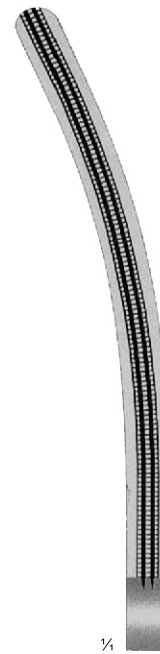

23-249-21
 21 cm, 8 1/4"



23-281-23
 23 cm, 9"

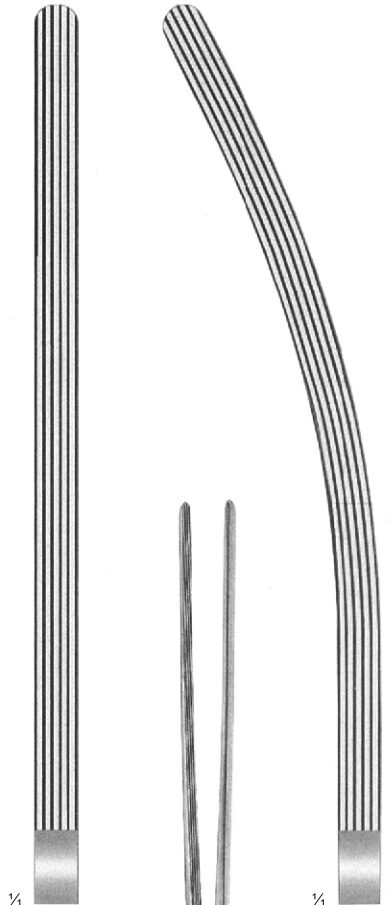
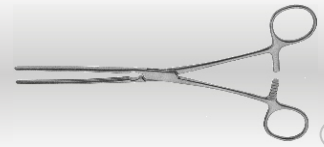

¼
 23-254-21
 21 cm, 18¼"
 23-254-23
 23 cm, 9"
 23-254-25
 25 cm, 10"

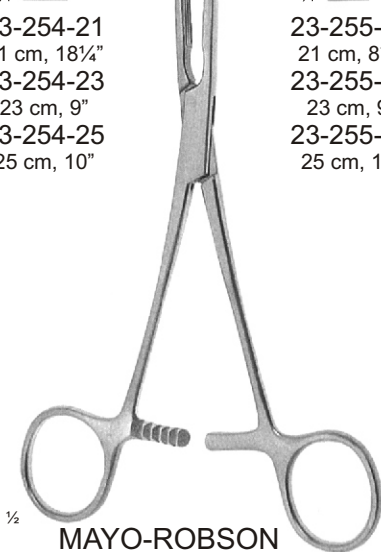

½
MAYO-ROBSON
 23-254-21
 23-255-25

Hard elastic with non-traumatic serration
 hart federnd, mit atraumatischer Riefung
 elásticas (duro), con bocas atraumáticas
 fermes, avec mors atrauma
 elastica duro, con morsi atraumatici

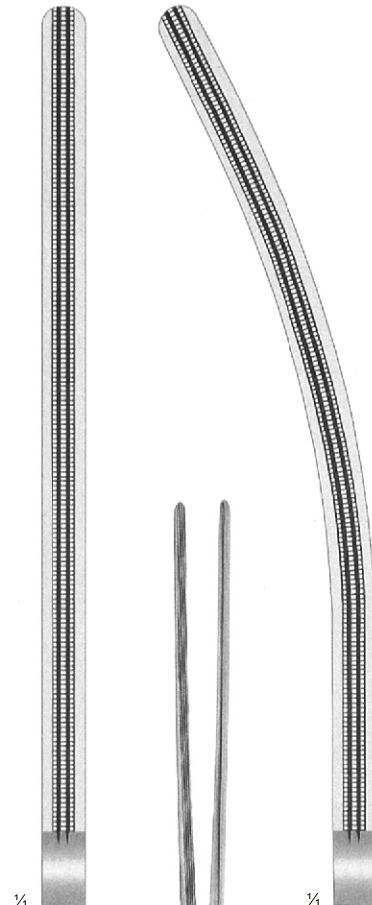

¼
 23-256-25
 25 cm, 10"



½
MAYO-ROBSON
 23-256-25
 23-257-25

Hard elastic with non-traumatic serration
 hart federnd, mit atraumatischer Riefung
 elásticas (duro), con bocas atraumáticas
 fermes, avec mors atrauma
 elastica duro, con morsi atraumatici

¼
 23-257-25
 25 cm, 10"

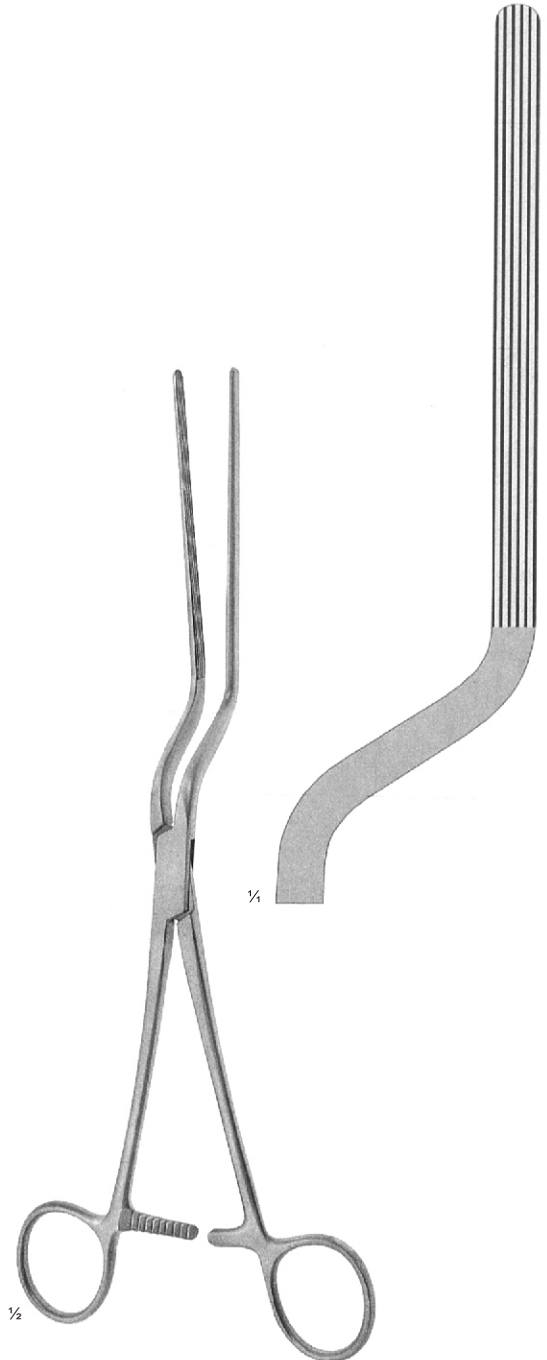

½

BRUNNER
 23-260-24
 24 cm, 9½"

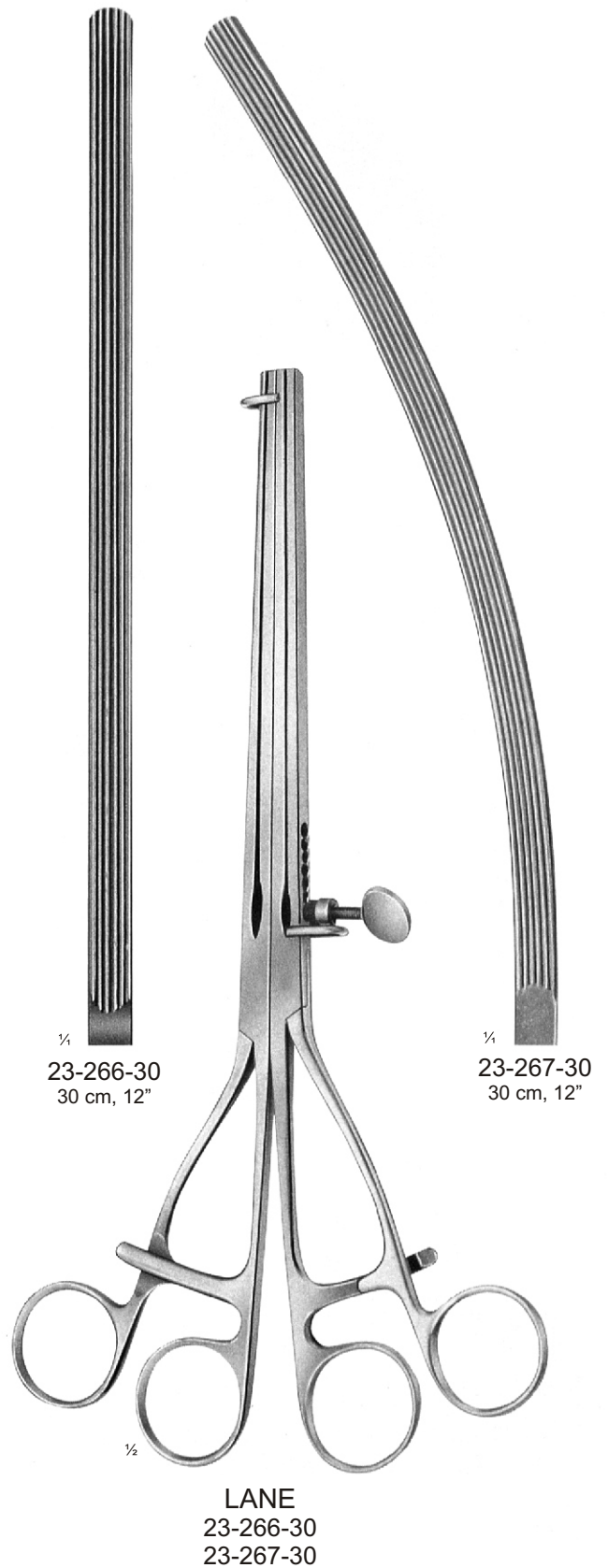
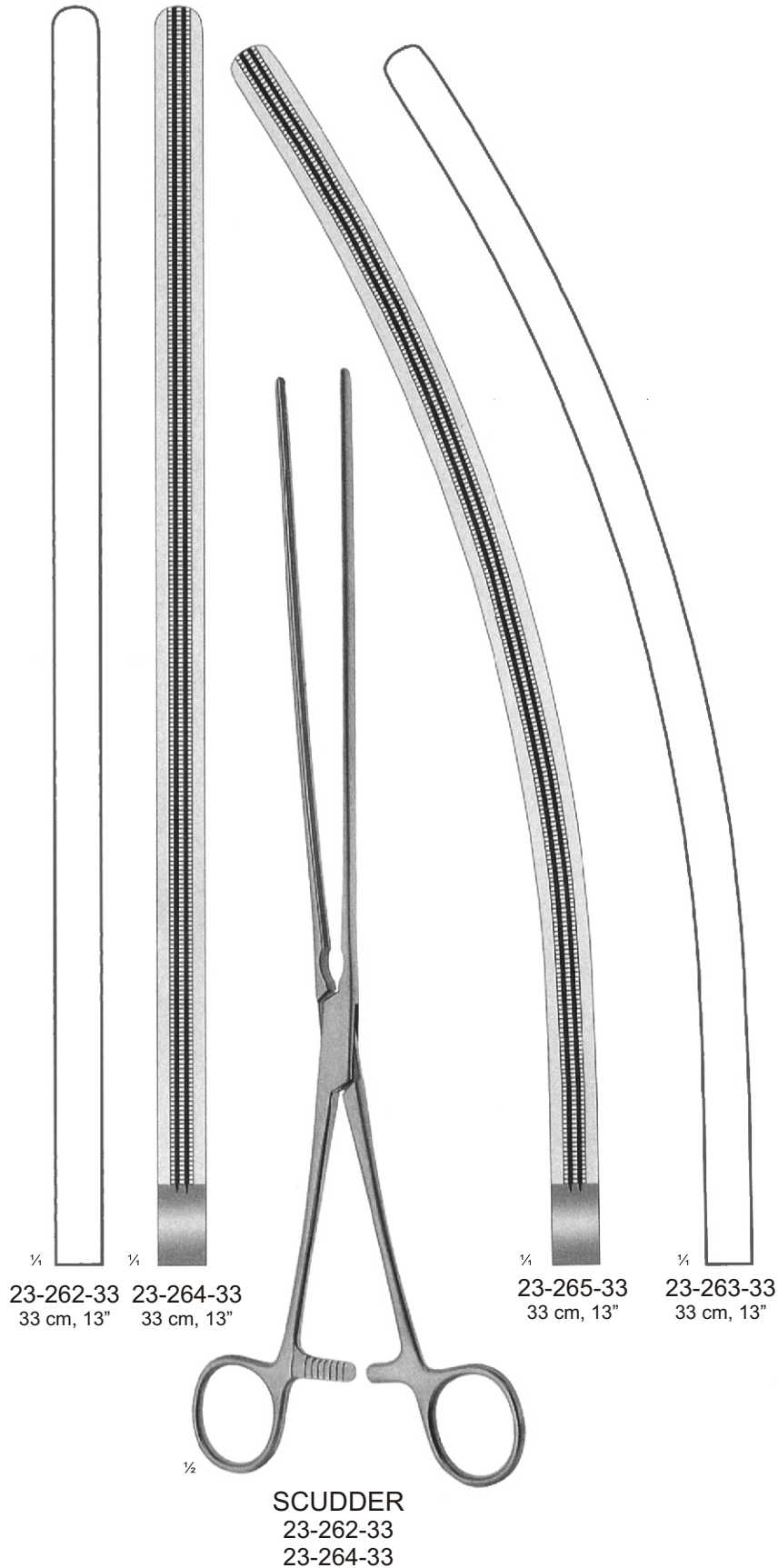
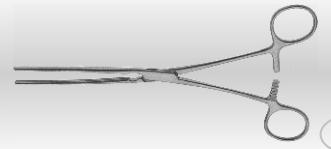

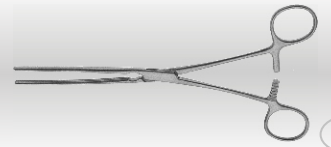

23-275-24
 24 cm, 9½"

23-273-24
 24 cm, 9½"

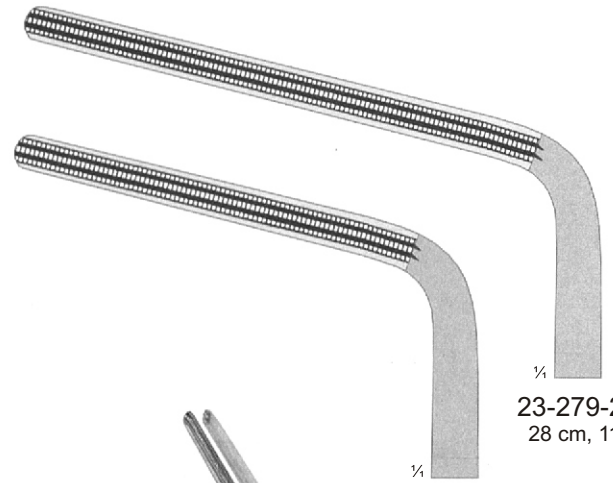

23-279-28
 28 cm, 11"

23-277-26
 26 cm, 10¼"

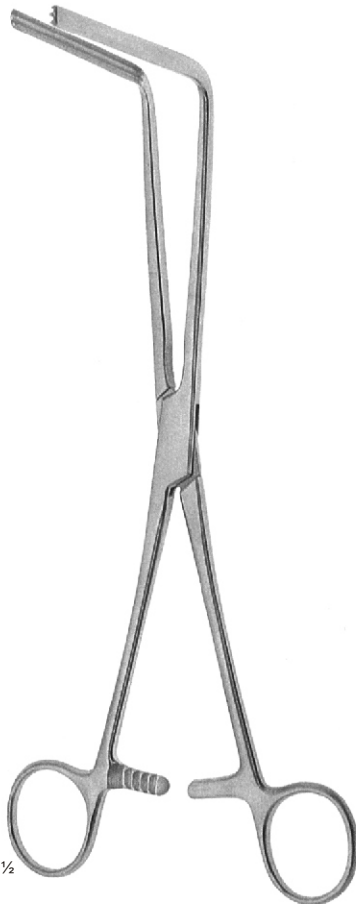

FEHLAND
 23-273-24
 23-275-24



HAYES
 23-277-26
 23-279-28

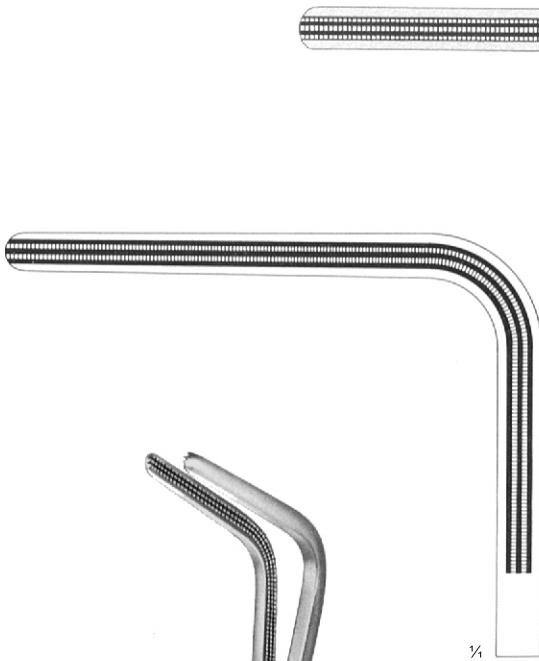
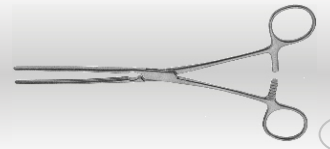

VEIDENHEIMER
 23-283-23
 23 cm, 9"

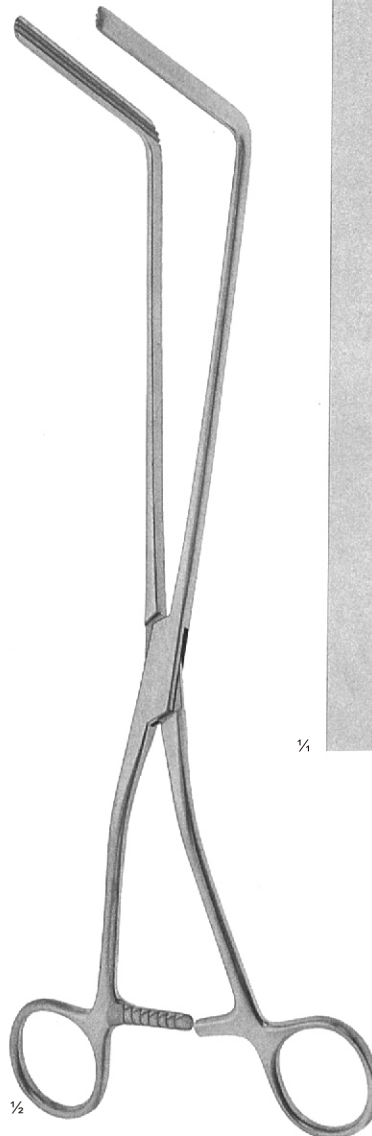
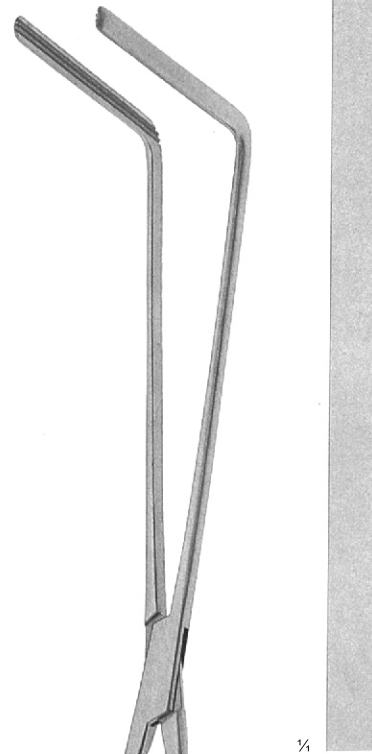

RESANO
 23-285-30
 30 cm, 12"

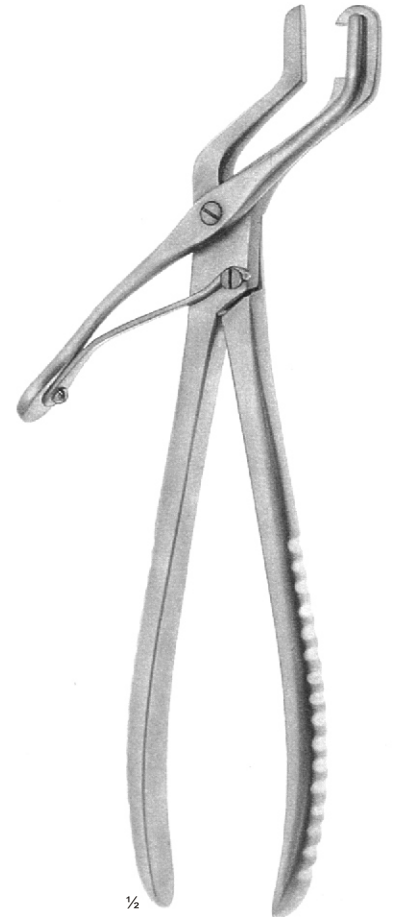

Clamp closing forceps
 Klemmschließzange
 Pinza para cerrar los clamps
 Pince pour fermer les clamps
 Serrapinze

DE MARTEL-WOLFSON
 23-288-26
 26 cm, 10 1/4"

Supur Crusher

Spornquetsche
Machadora para espora
Ecraseurs intestinaux
Pinza schiaccia sperone

Intestinal and Stomach Clamps

Darm- und Magenquetschklemmen
Pinzas-clamps intestinales y estomacales
Pince-clamps pour l'intestin l'estomac
Pinze/clamp per intestino e stomaco

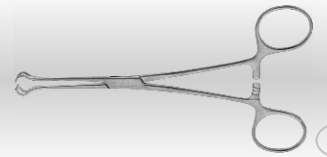

**Spur crusher and
appendectomy clamp**

Spornquetsche und
appendektomieklammer
Machadora para espora y
clamp para apendectomia
Ecraseur et clamp à
appendicectomie
Pinza schiaccia sperone e
clamp per appendicectomia

KLEINSCHMIDT
23-294-12
12,5 cm, 5"

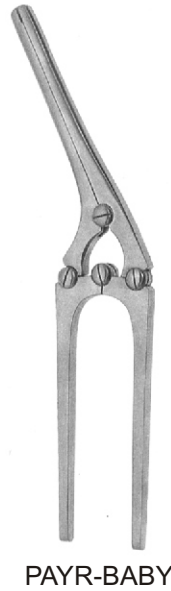

PAYR-BABY

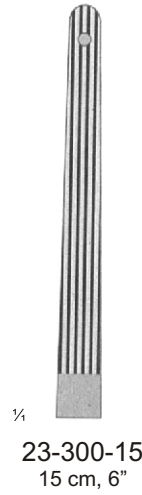

¼
23-300-15
15 cm, 6"

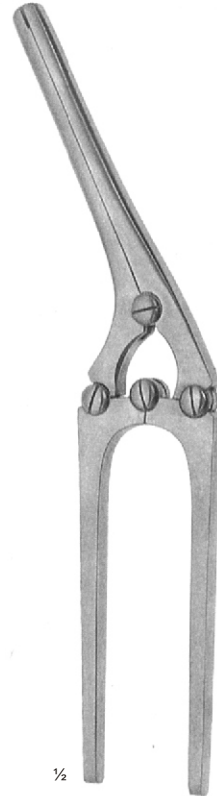

PAYR
23-300-15
23-300-35

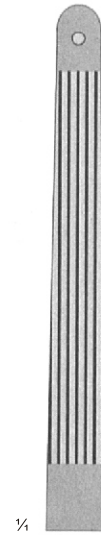

¼
23-300-21
21 cm, 8¼"

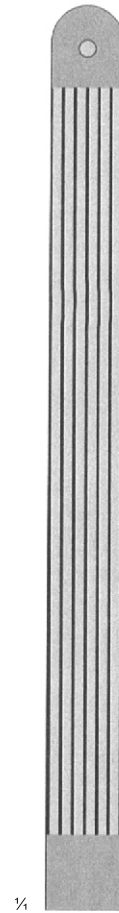

¼
23-300-29
29 cm, 11½"

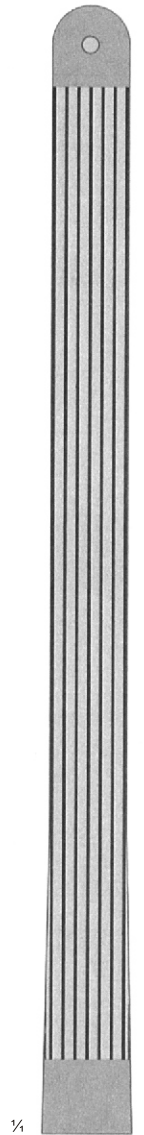

¼
23-300-35
35 cm, 13¼"

Intestinal and stomach clamps with pin
Darm- und Magenquetschklemmen mit Stift
Pinzas-clamps intestinales y estomacales con espiga
Pince-clamps et écraseurs pour l'intestin et l'estomac avec pointe
Clamp per intestino e stomaco con perno



Pylorus spreader
Pylorusspreizer
Separador para piloro
Ecarteur du pylore
Divaricatore per piloro

BABY BENSON
23-296-15
15,5 cm, 6"

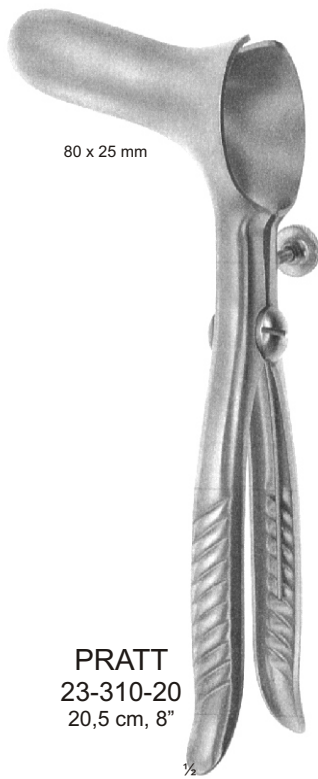
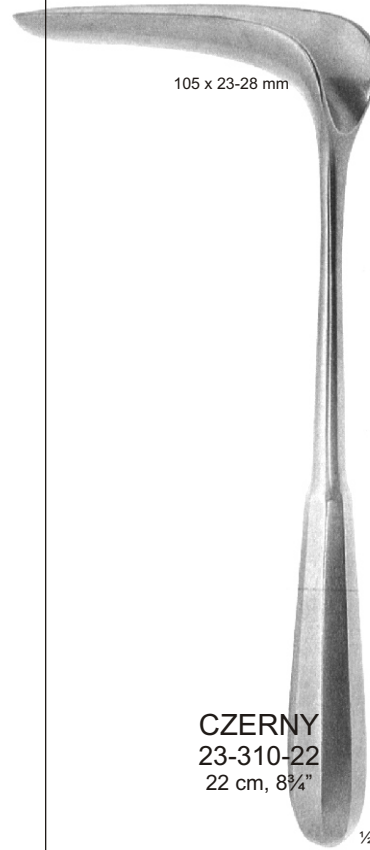
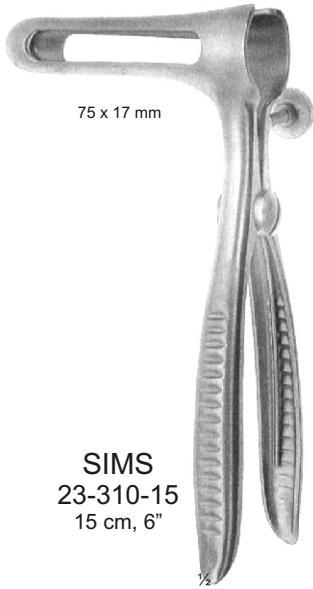
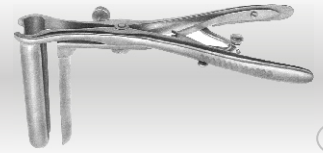

Sphincteroscopes

Spinkteroskopie
Esfinteroscopios
Sphinctérosopes
Sfinteroscopi

Anoscopes

Anuskope
Anoscopios
Anusopes
Anoscopi



Anoscopes
Anuskope
Anoscopios
Anusopes
Anoscopi

HIRSCHMANN

- 23-330-01 16 mm x 65 mm
- 23-330-02 19 mm x 65 mm
- 23-330-03 22 mm x 65 mm
- 23-330-04 22 mm x 65 mm

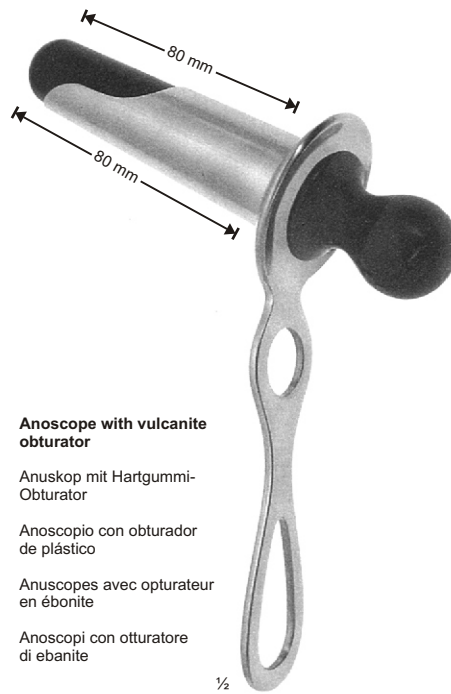

Anoscope with vulcanite obturator

Anoskop mit Hartgummi-Obturator

Anoscopio con obturador de plástico

Anusopes avec obturateur en ébonite

Anoscopi con otturatore di ebanite

IVES-FANSLER

- 23-332-01 22 mm x 80 mm



NEWMAN

- 23-334-01 16 mm x 63 mm
- 23-334-02 19 mm x 63 mm
- 23-334-03 23 mm x 63 mm

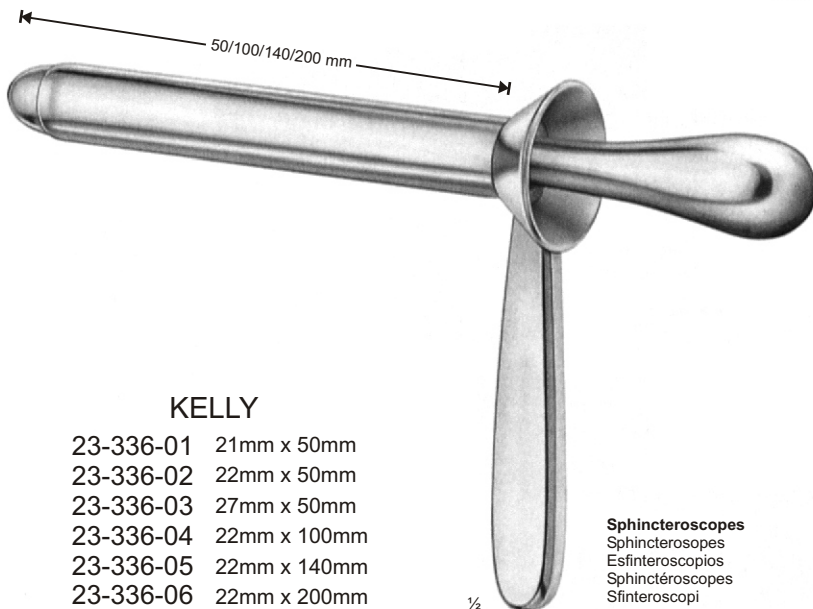

KELLY

- 23-336-01 21mm x 50mm
- 23-336-02 22mm x 50mm
- 23-336-03 27mm x 50mm
- 23-336-04 22mm x 100mm
- 23-336-05 22mm x 140mm
- 23-336-06 22mm x 200mm

Sphincteroscopes
Sphincterosopes
Esfinteroscopios
Sphinctérosopes
Sfinteroscopi

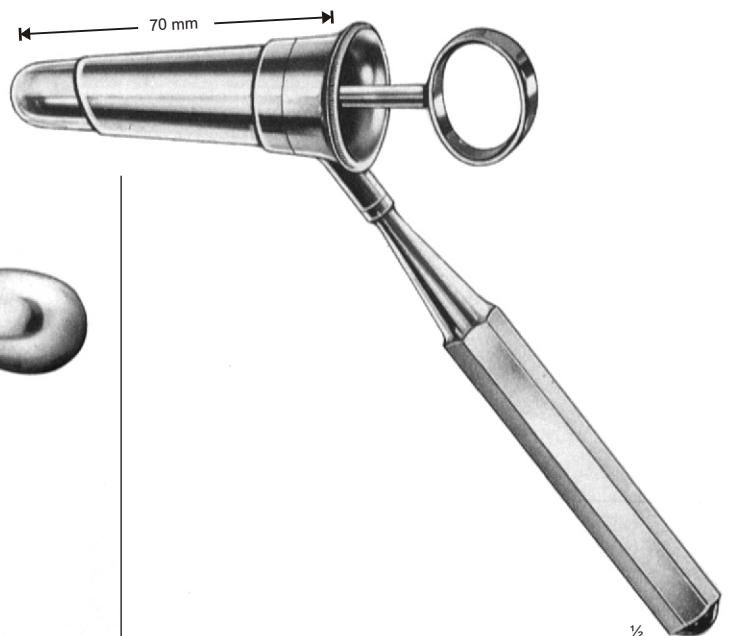

BENSAUDA

- 23-238-01 19 mm x 70 mm
- 23-238-02 19 mm x 70 mm

Rectal Retractors

Analspreizer
 Separadores para el recto
 Dilatateurs pour auns et rectum
 Dilatatori per l'ano ed it retto



023

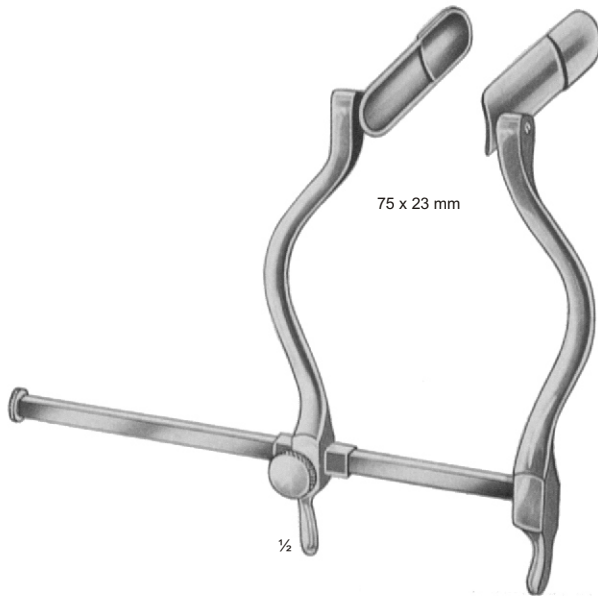

SMITH-BUIE
 23-340-15
 15 cm, 6"



70 x 22 mm

BARR
 23-342-17
 17 cm, 6¾"

23-350-03

23-350-02

23-350-01

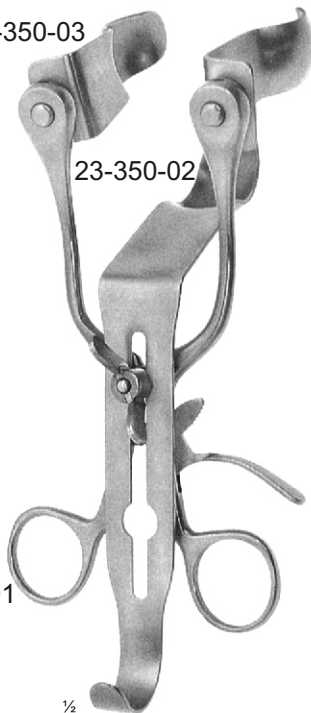

ALAN-PARK
 23-350-00
 13,5 cm 5¼"

Set, Setz, Juego, Jeu, Serie

Rectal retractor with ball snap closure, complete, consisting of:

- 23-350-01 1 Spreader
- 23-350-02 1 Central valve 95 x 22 mm
- 23-350-03 1 Pair lateral valves 75 x 22 mm
- 23-350-04 1 Pair lateral valves 95 x 22 mm

Analspreizer mit Kugelschnellverschluss, komplett, bestehend aus:

- 23-350-01 1 Sperrer
- 23-350-02 1 Mittelvalve 95 x 22 mm
- 23-350-03 1 Paar Seitenvalven 75 x 22 mm
- 23-350-04 1 Paar Seitenvalven 95 x 22 mm

Separador para el recto con cierre esférico, completo, compuesto de:

- 23-350-01 1 Separador
- 23-350-02 1 Valva central 95 x 22 mm
- 23-350-03 1 Par de valvas laterales 75 x 22 mm
- 23-350-04 1 Par de valvas laterales 95 x 22 mm

Ecarteur rectal, complet, composé de:

- 23-350-01 1 Dilatateur
- 23-350-02 1 Valve centrale 95 x 22 mm
- 23-350-03 1 Paire de valves latérales 75 x 22 mm
- 23-350-04 1 Paire de valves latérales 95 x 22 mm

Dilatatore rettale con chiusura a scatto completo, composto da:

- 23-350-01 1 Dilatatore
- 23-350-02 1 Valve centrale 95 x 22 mm
- 23-350-03 1 Paia di valve laterali 75 x 22 mm
- 23-350-04 1 Paia di valve laterali 95 x 22 mm

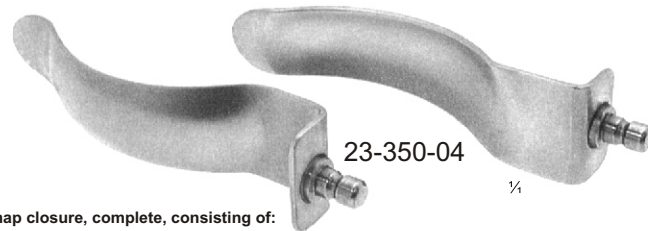

23-350-04

¼



Cotton carrier
Watteträger
Porta-algodón
Porte-cotons
Portacotone

Rectal Probes
Analsonden
Sondas para el recto
Sondes rectales
Sonde rettali

Pressure clamp
Druckklemme
Pinza-clamp de presión progresiva
Pince-clamp à pression
Pinza/clamp a pressione



023

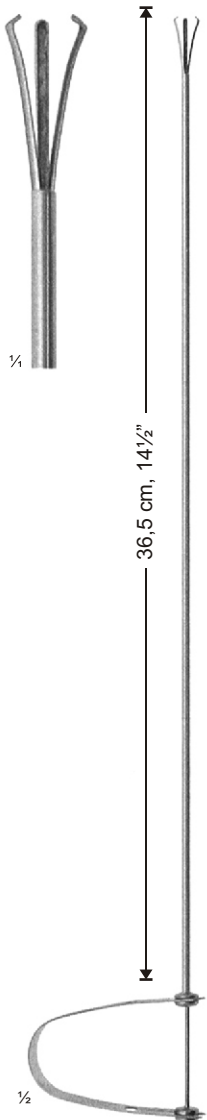

36,5 cm, 14½"

EDER
23-360-36
36,5 cm, 14½"

Cotton carrier
Watteträger
Porta-algodón
Porte-cotons
Portacotone

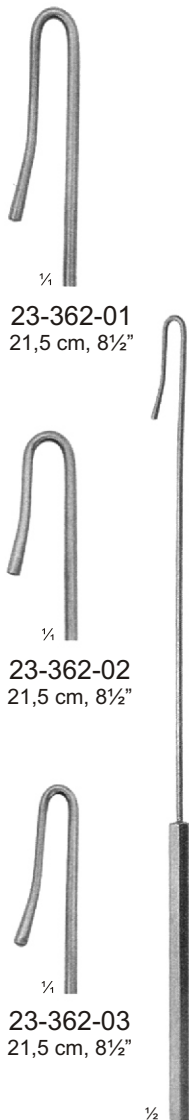

23-362-01
21,5 cm, 8½"

23-362-02
21,5 cm, 8½"

23-362-03
21,5 cm, 8½"

Fistula probes (crypt hooks)
Fistelnsonden (Krypthaken)
Sondas para fistula (gancho para cripta)
Sondes pour fistules (crochets à crypte)
Sonde per fistola (gancio a cripta)

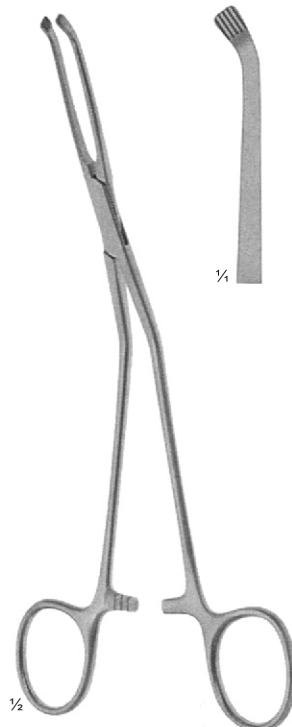

MC GIVNEY
23-365-19
19 cm, 7½"

Haemorrhoidal forceps
Hämorrhoiden-Faßzange
Pinza-clamp para hemorroides
Pinces-ciamps pour hémorroides
Pinze per emorroidi



BUIE
23-367-21
21 cm, 8¼"

Pressure clamp
Druckklemme
Pinza-clamp de presión progresiva
Pince-clamp à pression
Pinza/clamp a pressione

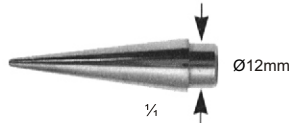

Haemorrhoidal ligator with loading attachment ø 12 mm
 Hämorrhoiden-Ligator mit Ladekonus ø 12 mm
 Ligador para hemorroides con cono de carga ø 12 mm
 Ligateur hémorroïdal avec cône de charge ø 12 mm
 Legatori emorroidali con carica a cono ø 12 mm



RUDD
 23-380-27
 27,5 cm, 10¾"



FORD DIXON
 23-386-00

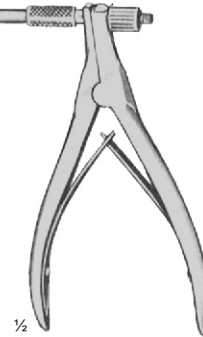

MC GIVNEY
 23-388-00



Haemorrhoidal suctionligator with finger cut-off and loading cone
 Hämorrhoiden-Saugligator mit Unterbrecher und Ladekonus
 Ligador de aspiración para hemorroides con interruptor y cono de carga
 Ligateur aspirateur pour hémorroïdes avec interrupteur et cône d'aspiration
 Legatore emorroidale con aspiratore, leva d'arresto e cone di carica

23-390-01
 33,5 cm, 13¼"

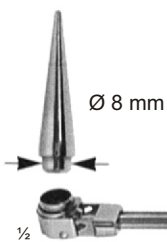

23-390-03
 36,5 cm, 14½"

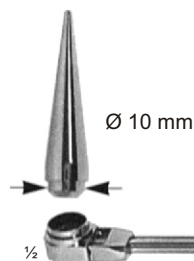

23-390-02
 36,5 cm, 14½"



Rectal Biopsy Specimen forceps
 Mastdarm-Biopsiezangen
 Pinzas sacabocado para biopsia rectal
 Pinces à biopsie rectale
 Pinze taglianti per biopsia rettale

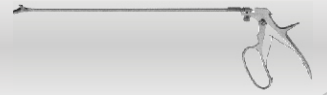

023

