

025

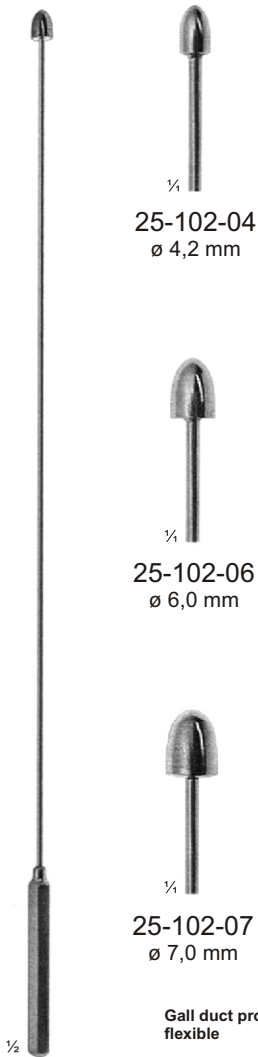

**Gall, Liver, Kidney, Bladder, Urology**  
**Galle, Leber, Niere, Blase, Urologie**  
**Bilis, Hígado, Riñón, Vejiga, Urología**  
**Bile, Foie, Rein, Vessie, Urologie**  
**Bile, Fegato, Rene, Vescica, Urologia**



25-102-04  
 ø 4,2 mm

25-102-06  
 ø 6,0 mm

25-102-07  
 ø 7,0 mm

**Gall duct probes flexible**

Gallengangsonden federn

Sondas para el conducto biliar, flexible

Dilatateurs à voies biliaires flexible

Dilatatore per condotti biliari flessibili

**DESJARDINS**  
 25-102-04  
 25-102-07  
 28 cm, 11"

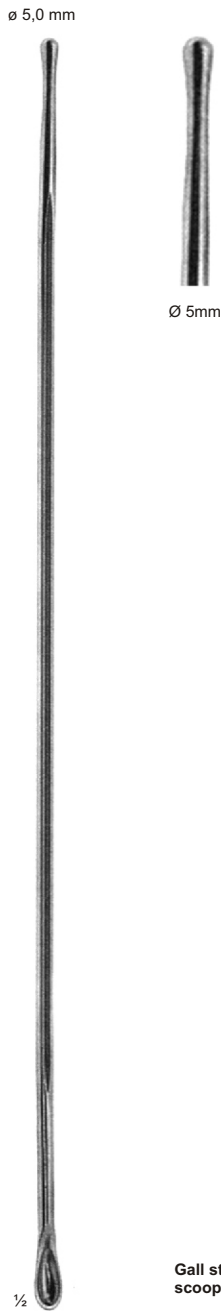

ø 5,0 mm

ø 5mm

**Gall stone probe and scoop of tin, malleable**

Gallensteinsonde und -löffel aus zinn, biegsam

Sonda y cucharilla para los cálculos biliares, maleable

Sonde-curette pour vésicule biliaire, malléable

Sonda con cucchiaino per calcoli biliari, malleabile

**MOYNIHAN**  
 25-106-34  
 34 cm, 13½"

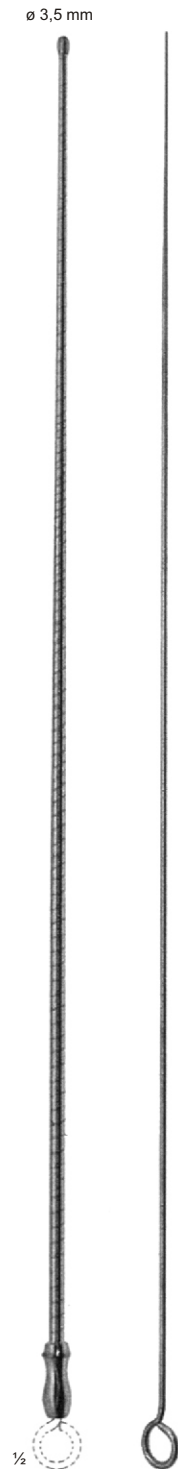

ø 3,5 mm

ø 3.5mm

**Gall duct probes flexible**

Gallengangsonde, federn

Sonda para el conducto biliar, flexible

Dilatateur à voies biliaires flexible avec conducteur

Dilatatore per condotti biliari flessibile

**OCHSNER**  
 25-108-38  
 38 cm, 15¼"

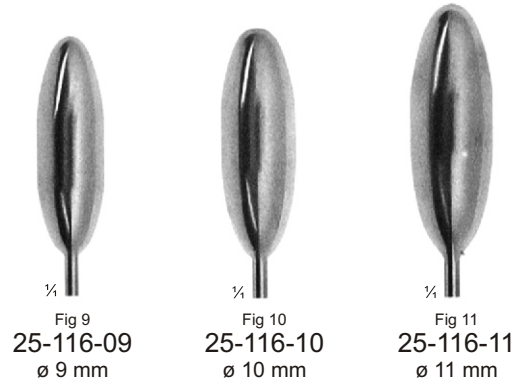
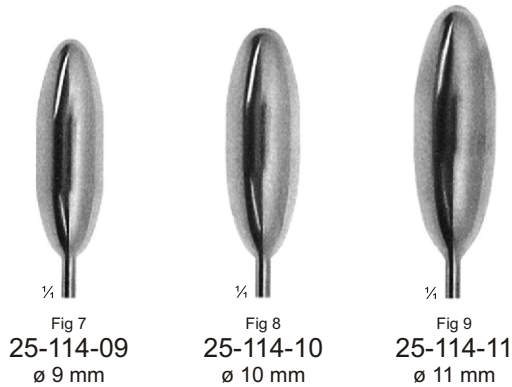
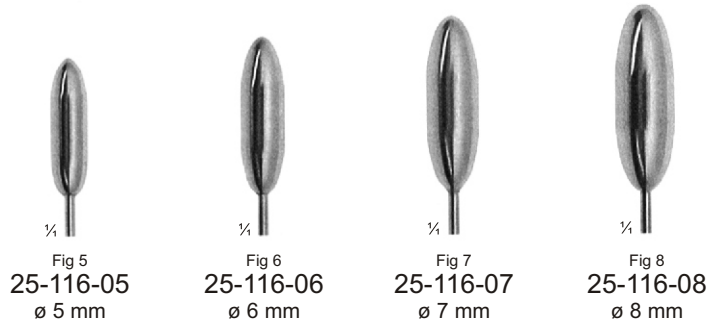
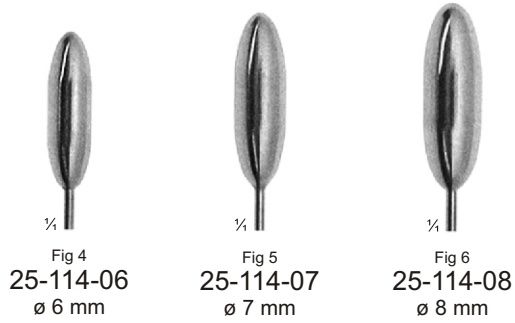
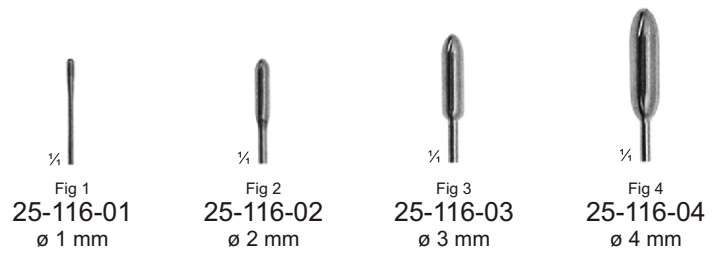
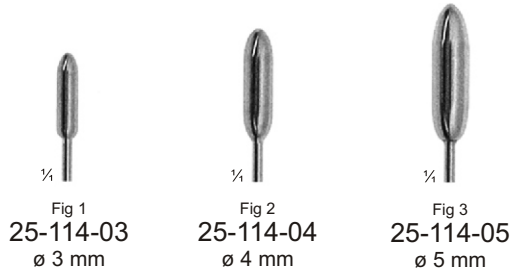
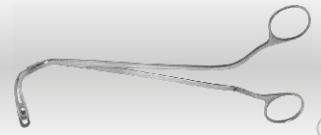

**BAKES**  
 25-114-03  
 25-116-11  
 30 cm 12"

**BAKES**  
 25-114-00  
 Set , Setz , Juego , Jeu , Serie

Set of 9 common bile duct dilators 25-114-03 to 25-114-11 malleable, in plastic roll (25-114-00)

Satz von 9 Gallengang-Dilatationsölvn 25-114-03 bis 25-114-11 biegsam, in Plastiktasche (25-114-00)

Juego de 9 dilatadores para el conducto biliar del 25-114-03 al 25-114-11 maleable, en bolsa de plástico (25-114-00)

Jeu de 9 dilatateurs biliaires du 25-114-03 au 25-114-11 malléables en sachet plastique (25-114-00)

Set di 9 dilatatori per condotti biliari dal 25-114-03 al 25-114-11 malleabili, con rotolo di plastica (25-114-00)

**BAKES**  
 25-116-01  
 25-116-13  
 30 cm 12"

**BAKES**  
 25-116-00

Set of 13 common bile duct dilators 25-116-01 to 25-116-13 malleable, in plastic roll (25-116-00)

Satz von 13 Gallengang-Dilatationsölvn 25-116-01 bis 25-116-13 biegsam, in Plastiktasche (25-116-00)

Juego de 13 dilatadores para el conducto biliar del 25-116-01 al 25-116-13 maleable, en bolsa de plástico (25-116-00)

Jeu de 13 dilatateurs biliaires du 25-116-01 au 25-116-13 malléables en sachet plastique (25-116-00)

Set di 13 dilatatori per condotti biliari dal 25-116-01 al 25-116-13 malleabili, con rotolo di plastica (25-116-00)

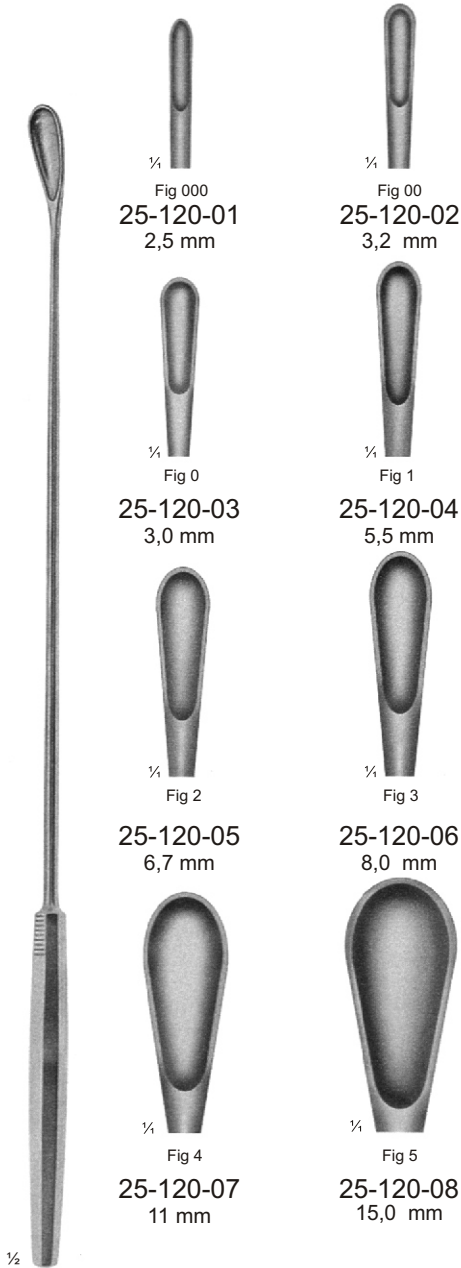
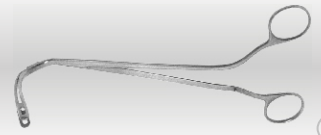

**LUER-KOERTE**  
 25-120-01  
 25-120-08  
 32 cm, 12¾"

**Gall stone scoops, malleable**  
 Gallensteinlöffel, biegsam  
 Cucharillas para los cálculos biliares, maleable  
 Curettes pour calculs biliaires, malléables  
 Cucchiari per calcoli biliari, malleabili



**MAYO**  
 25-124-28  
 28 cm, 11"

**Gall stone scoops**  
 Gallensteinlöffel  
 Cucharillas para los cálculos biliares  
 Curettes pour calculs biliaires  
 Cucchiari per calcoli biliari

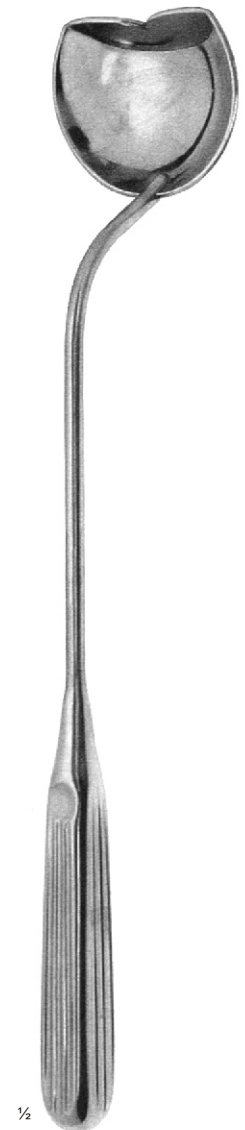

**MOORE**  
 25-128-28  
 28 cm, 11"

**Gall bladder scoop**  
 Gallenblasenlöffel  
 Cucharilla para la vesícula biliar  
 Cuillère pour vésicule biliaire  
 Cucchiario per colecisti



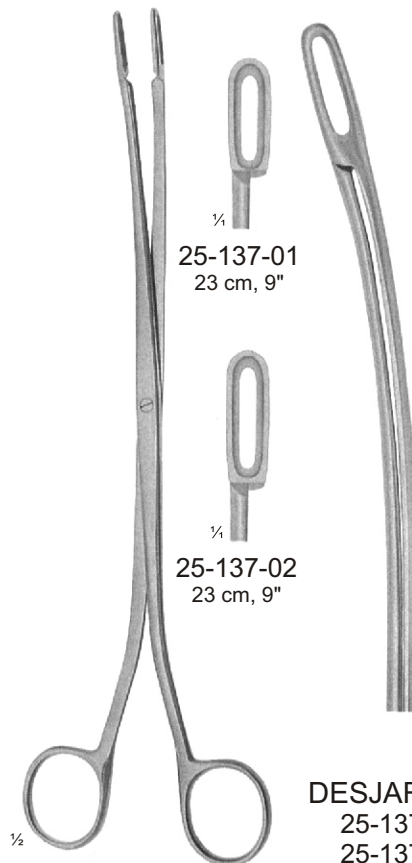
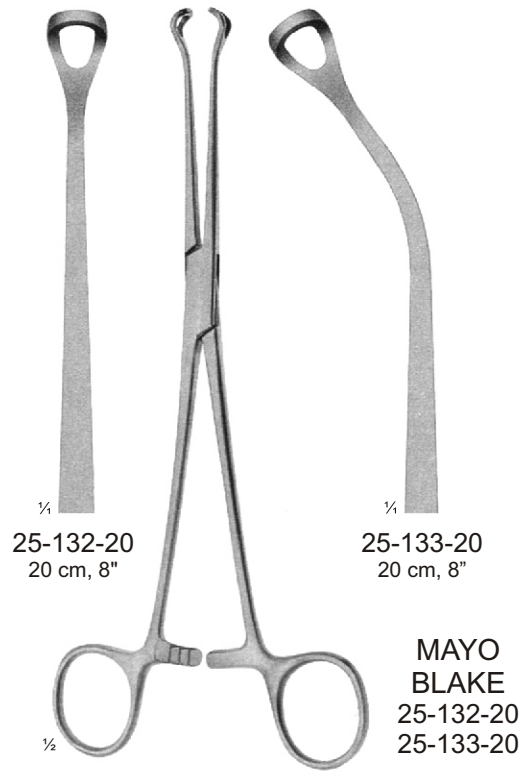
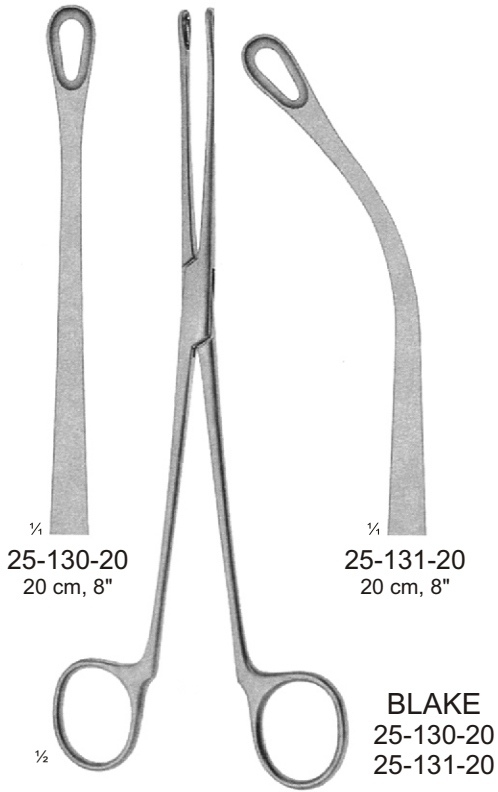

**DARTIGUES**  
25-150-27  
27 cm, 10¼"

**Kidney elevating forceps**  
 Nierenfaßzange  
 Pinza para sostener el riñón  
 Hystérolabe  
 Pinza per afferrare il rene



### Kidney Stone Forceps

Nierensteinzangen

Pinzas para los cálculos renales

Pinces pour les calculs rénaux

Pinze per calcoli renali



025



25-155-01  
23 cm, 9"



25-155-02  
22 cm, 8¾"

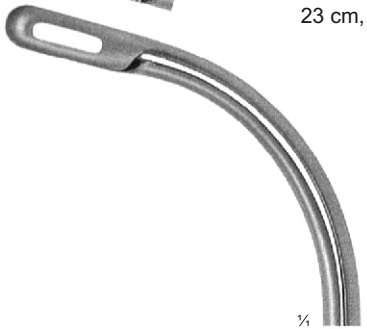

25-155-03  
22 cm, 8¾"



25-155-04  
22 cm, 8¾"

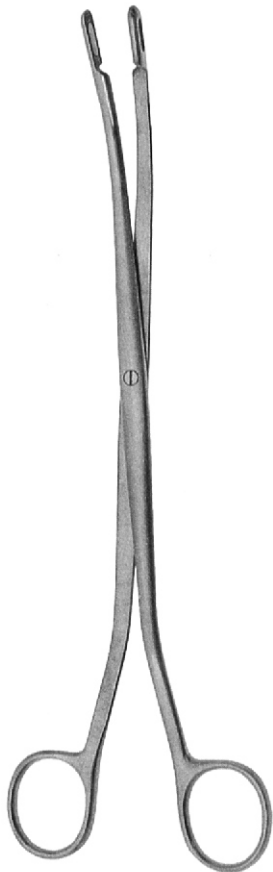

RANDALL  
25-155-01  
25-155-04



25-157-01  
19 cm, 7½"



25-157-02  
19 cm, 7½"

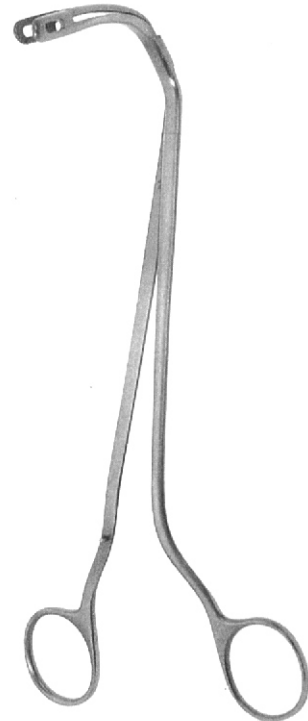

RANDALL  
25-157-01  
25-157-02

Kidney Stone Forceps  
Nierensteinzangen  
Pinzas para los cálculos renales  
Pinces pour les calculs rénaux  
Pinze per calcoli renali

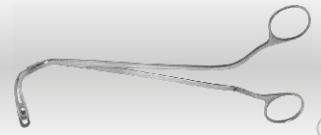

**ELSASSER**  
 25-170-20  
 20 cm, 8"



**ELSASSER**  
 25-172-20  
 20 cm, 8"

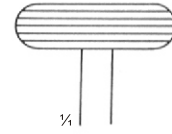

**25-184-01**  
 23 cm, 9"  
 Fig. 1

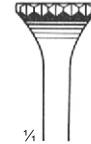

**25-184-02**  
 23 cm, 9"  
 Fig. 2

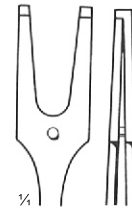

**25-184-03**  
 24 cm, 9½"  
 Fig. 3

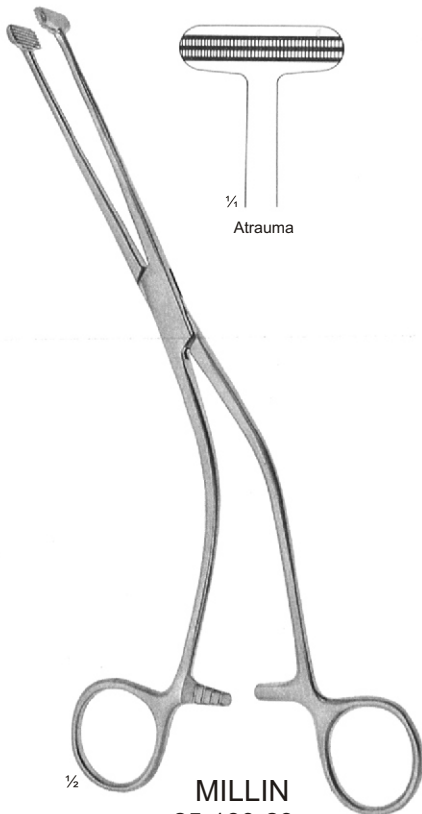

**MILLIN**  
 25-180-23  
 23 cm, 9¼"



**MILLIN**  
 25-182-24  
 24,5 cm, 9¾"



**MILLIN**  
 25-184-01  
 25-184-03

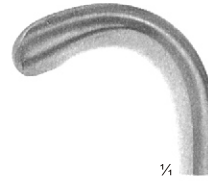
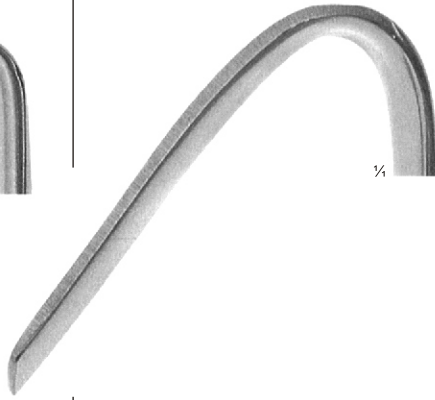
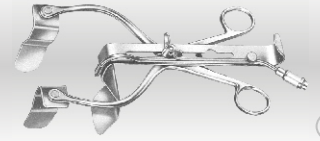

**YOUNG**  
 25-190-21  
 21,5 cm, 8½"

lateral  
 lateral  
 lateral  
 latéral  
 laterale



**YOUNG**  
 25-192-21  
 21 cm, 8½"

anterior  
 anterior  
 anterior  
 antérieur  
 anteriore

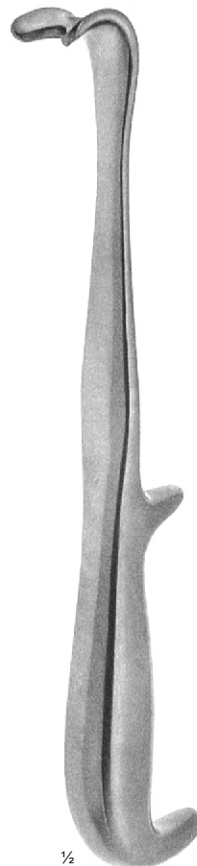

**YOUNG**  
 25-194-22  
 22 cm, 8¾"

**Bulbus hook**  
 Bulbus-Haken  
 Gancho para el bulbus  
 Crochet en bulbus  
 Bulbo ad uncino



**YOUNG**  
 25-196-21  
 21 cm, 8½"

**forked**  
 gegabelt  
 horquilla  
 en fourche  
 a forchetta



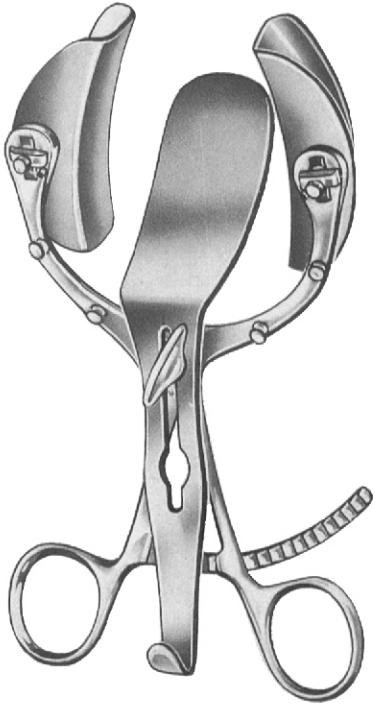
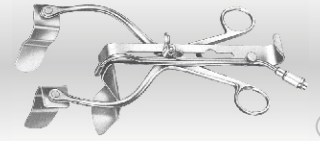

**LEGUEU**  
25-200-00

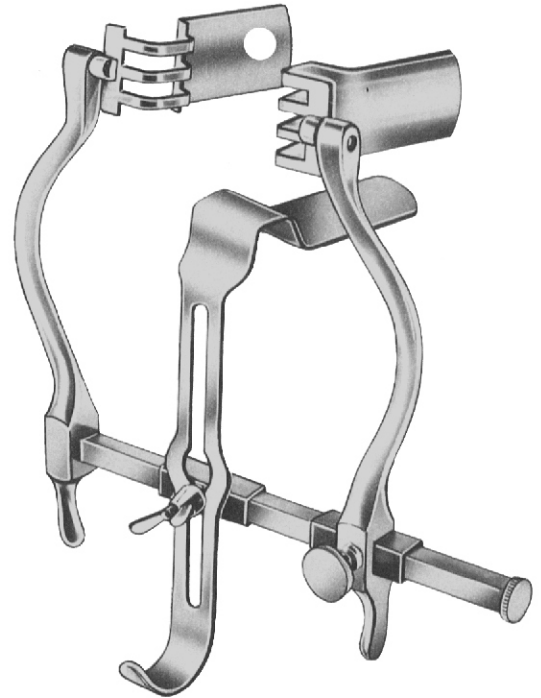

**JUDD-MASSON**  
25-202-00

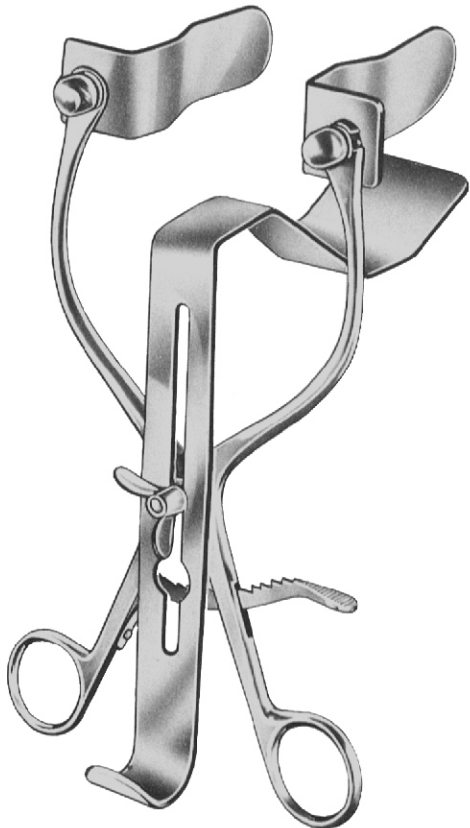

**MILLIN**  
25-204-00



**MILLIN**  
25-206-00

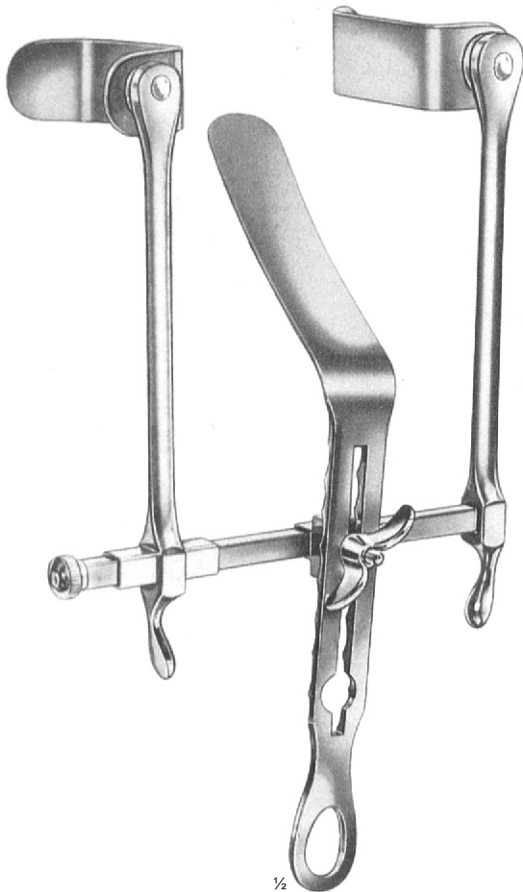
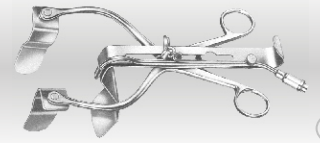

**TOMSON-WALKER**  
 25-210-00

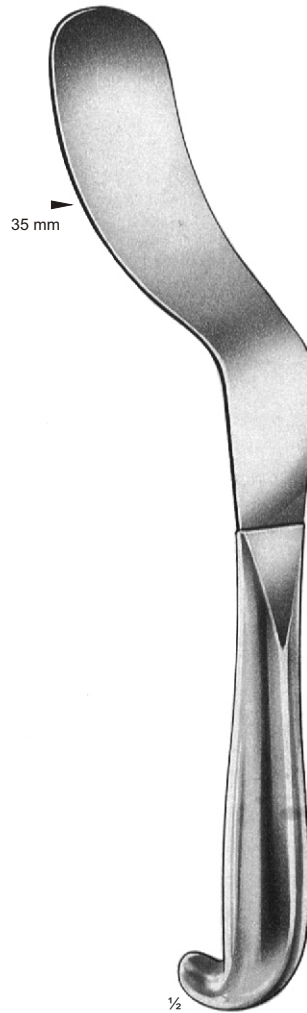

**LEGUEU**  
 25-212-27  
 27 cm, 10 1/2"

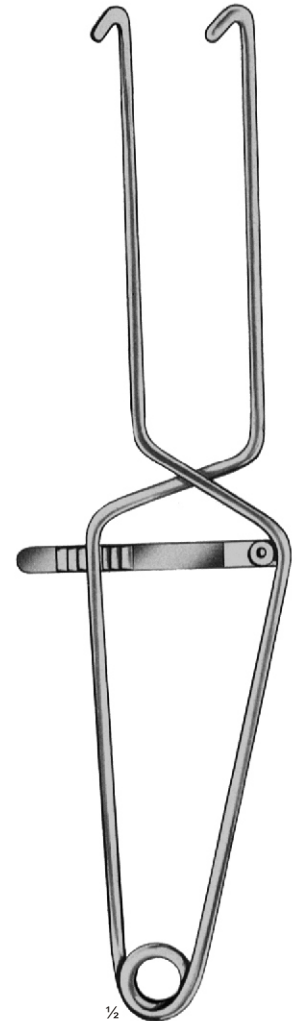

**MILLIN**  
 25-214-29  
 29,5 cm, 11 3/4"

**Bladder neck spreader**  
 Blasenhalsspreizer  
 Dilatador para el cuello vesical  
 Dilatateur vésicale  
 Dilatatore per collo vescicale



1/2



1/2



1/2



1/2

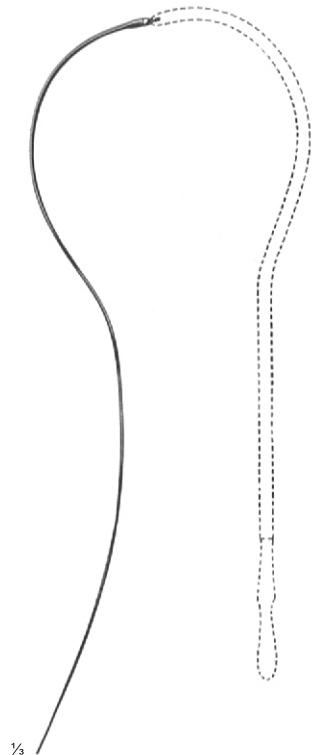

1/2

**VAN BUREN**

	Ø mm	Chr. (French)
25-220-08	2 1/4	8
25-220-09	3	9
25-220-10	3 3/4	10
25-220-12	4	12
25-220-14	4 3/4	14
25-220-16	5 1/2	16
25-220-18	6	18
25-220-20	6 3/4	20
25-220-22	7 1/2	22
25-220-24	8	24
25-220-26	8 3/4	26
25-220-28	9 1/2	28
25-220-30	10	30
25-220-32	10 3/4	32
25-220-34	11 1/2	34
25-220-36	12	36

**Dilating bougies**  
 Dilatationsbougies  
 Bujías dilatadoras  
 Bougies dilatatrices  
 Candelette dilatatrici

15 cm, 6"	Ø mm	Chr. (French)	25 cm, 10"
25-224-08	2 3/4	8	25-225-08
25-224-10	3 3/4	10	25-225-10
25-224-12	4	12	25-225-12
25-224-14	4 3/4	14	25-225-14
25-224-16	5 1/4	16	25-225-16
25-224-18	6	18	25-225-18
25-224-20	6 3/4	20	25-225-20

**Metal Catheters for men**

Metallkatheter für männer

Sondas metálicas para hombres

Sondes vésicales métalliques pour hommes

Cateteri metallici per uomini

**Metal Catheters for women**

Metallkatheter für frauen

Sondas metálicas para mujeres

Sondes vésicales métalliques pour femmes

Cateteri metallici per donne

**25-228-26**  
 26 1/2 cm, 10 1/2"

**Secretion curette malleable**

Sekretlöffel, biegsam

Cucharilla para secreción, maleable

Cuillère pour prélèvements des sécrétions, malléables

Curetta per secrezioni, malleabile

**FILIFORM**  
 25-230-12

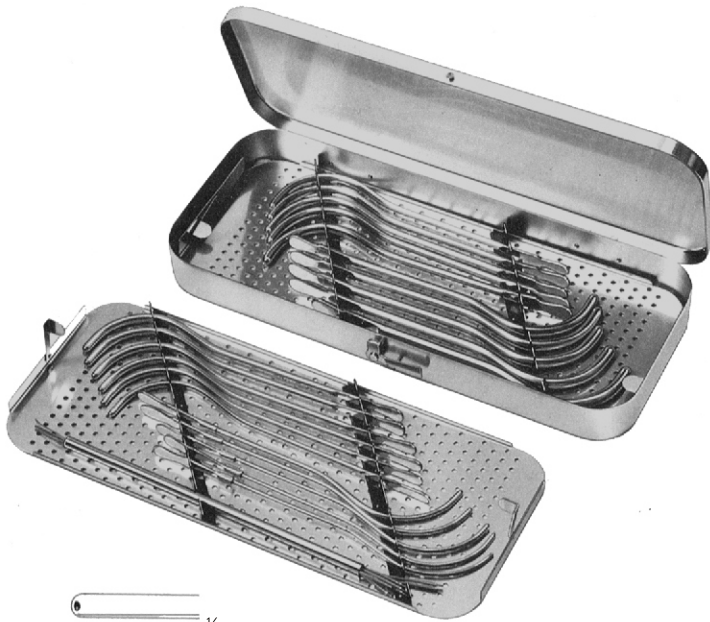

**GUYON**  
 25-234-00  
 420 x 175 x 40mm

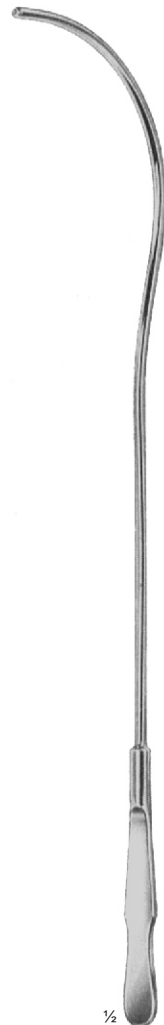

**GUYON**  
 25-234-10  
 25-234-30  
 Chr, French  
 No, 10-30

1/2



1/2

**GUYON**  
 25-236-39  
 39 cm, 15 1/2"

**Catheter introducing instrument**

Katheter-Einführungsinstrument

Instrumento para introducir catéteres

Mandrin pour sondes en gomme

Stumento per introdurre cateterali o sonde

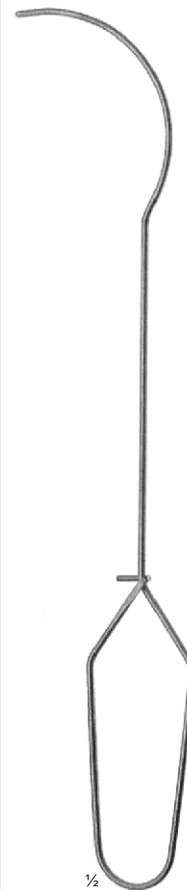

1/2

**GUYON**  
 25-238-35  
 35 cm, 13 3/4"

**Catheter guide (introducer)**

Katheterspanner und Einführungsinstrument

Guía para catéteres (introductor)

Mandrin pour sondes

Catetere guida (Interduttore)



1/4



1/2

**25-244-14**  
 14,5 cm, 5 3/4"

**Fixation clamp for the spermatic cord**

Klemme zum fixieren des Samenstrangs

Piza para fijar el cordón espermático

Pince pour fixer le cordon

Pinza per fissare il tronco spermatico



**Genito-Urinary Instruments**  
 Urologie-Instrumente  
 Instrumentos para la urología  
 Instruments pour l'urologie  
 Strumenti per l'urologia



025

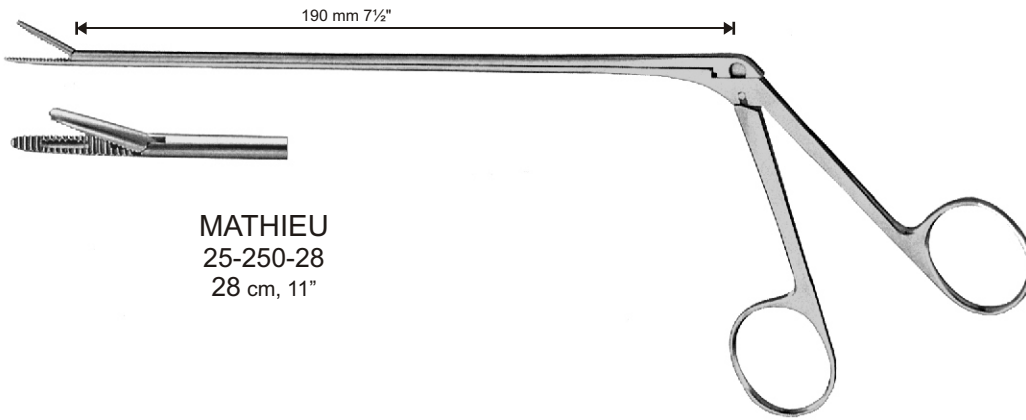

**MATHIEU**  
 25-250-28  
 28 cm, 11"

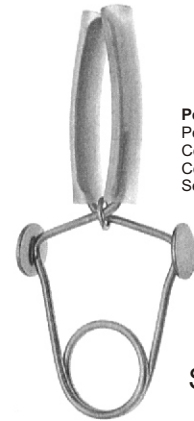

**Penis clamp**  
 Penisklemme  
 Compresseur urétral  
 Compresseur de l'urètre  
 Serrapene

**STRAUSS**  
 25-255-11  
 11 cm, 4 3/4"

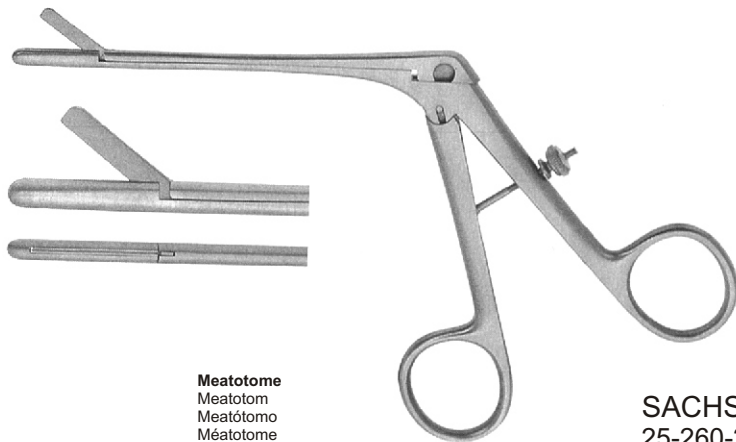

**Meatotome**  
 Meatotom  
 Meatótomo  
 Méatotome  
 Meatotomo

**SACHSE**  
 25-260-20  
 20 cm, 8"

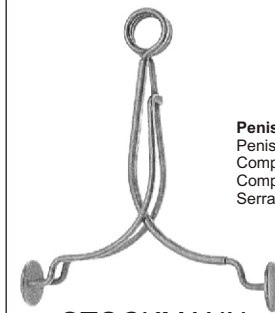

**Penis clamp**  
 Penisklemme  
 Compresseur urétral  
 Compresseur de l'urètre  
 Serrapene

**STOCKMANN**  
 25-265-08  
 8 cm, 3 1/4"

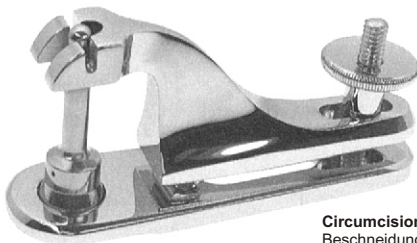

**Circumcision instruments**  
 Beschneidungs- (Circumcisions-) Instrumente  
 Instrumento para circuncisión  
 Instrument de circoncision  
 Strumento per circoncisione

25-270-08 ø8mm  
 baby size, für Säuglinge, para bebés, pour bébés, per neonati

25-270-11 ø11mm

25-270-13 ø13mm

child size, für Knaben, para niños, pour garçons, per bambini

25-270-16 ø16mm

25-270-21 ø21mm

adolescent size, für jugendliche, para adolescentes,  
 pour adolescents, per adolescent

25-270-26 ø26mm

25-270-32 ø32mm

men,s size, für Männer, para hombres, pour hommes, per uomini



**MOGEN**  
 25-272-07  
 7,5 cm, 3"

**Circumcision instrument**  
 Beschneidungs- (Circumcisions-) Instrument  
 Instrumento para circuncisión  
 Instrument de circoncision  
 Strumento per circoncisione