

027



Gynecology
Gynäkologie
Ginecología
Gynècologie
Ginecologia



Vaginal speculum for virgins with lateral fixation screw, tilt-down handle

Scheidenspekulum für Jungfrauen, mit zentraler Stellschraube, Griff umlegbar

Espéculo vaginal para vírgenes, con tornillo de sujeto lateral, mango plegable

Spéculum vaginal pour vierges, avec fixation centrale à vis

Speculo vaginale per vergini, con vite di regolazione laterale



CUSCO
27-110-01
75 x 17 mm

Vaginal speculum for virgins with central fixation screw, tilt-down handle

Scheidenspekulum für Jungfrauen, mit zentraler Stellschraube, Griff umlegbar

Espéculo vaginal para vírgenes, con tornillo de sujeto central, mango plegable

Spéculum vaginal pour vierges, avec fixation centrale à vis

speculo vaginale per vergini, con vite di regolazione centrale



CUSCO
27-112-01
75 x 17 mm

Scheme of dimensions for specula
Maßschema für Spekula
Esquema de dimensiones para espéculos
Schéma de dimensions pour les spéculum
Schema di dimensioni per specoli

Width of blades
Blattbreite
Anchura de valvas
Largeur de valves
Larghezza delle valve

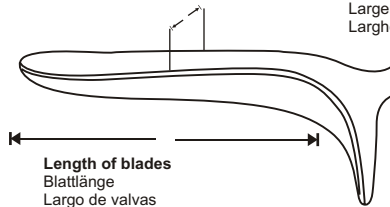

Length of blades
Blattlänge
Largo de valvas
Longueur des valves
Lunghezza delle valve

Vaginal specula with lateral fixation screw, tilt-down handle

Scheidenspekula mit seitlicher Stellschraube, Griff umlegbar

Espéculos vaginales con tornillo de sujeto lateral, mango plegable

Spéculum vaginaux, avec fixation latérale à vis

Speculi vaginali, con vite di regolazione laterale



CUSCO
27-114-01 75 x 32 mm
27-114-02 85 x 35 mm
27-114-03 100 x 35 mm

Vaginal specula with central fixation screw, tilt-down handle

Scheidenspekula mit zentraler Stellschraube, Griff umlegbar

Espéculos vaginales con tornillo de sujeto central, mango plegable

Spéculum vaginaux, avec fixation centrale à vis

Speculi vaginali, con vite di regolazione centrale

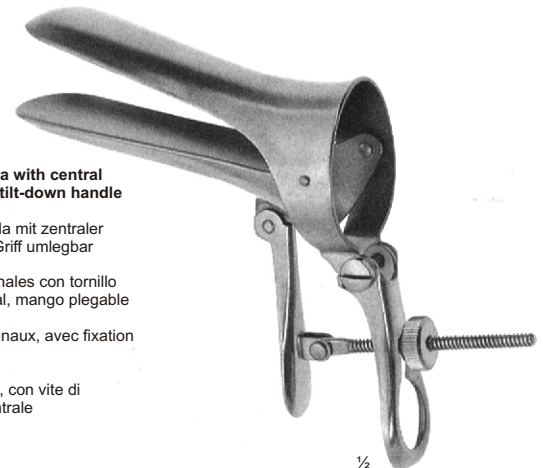

CUSCO
27-116-01 75 x 32 mm
27-116-02 85 x 35 mm
27-116-03 100 x 37 mm



Vaginal specula, Swiss pattern, cone shaped, with lateral fixation screw, tilt-down handle

Scheidenspekula, Schweizer Modell (konisch), mit seitlicher Stellschraube, Griff umlegbar

Espéculos vaginales, modelo suizo (cónico), con tornillo de sujeto lateral, mango plegable

Spéculums vaginaux, modèle suisse (conique), avec fixation latérale à vis

Speculi vaginali, modello svizzero, profilo a cono con vite di regolazione laterale

CUSCO

27-120-01 90 x 22
27-120-02 100 x 25
27-120-03 105 x 27

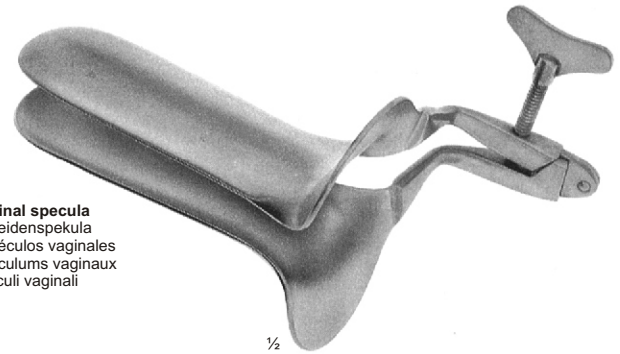

Vaginal specula
Scheidenspekula
Espéculos vaginales
Spéculums vaginaux
speculi vaginali

1/2

COLLIN

27-124-01 85 x 30mm
27-124-02 100 x 35 mm
27-124-03 110 x 40 mm

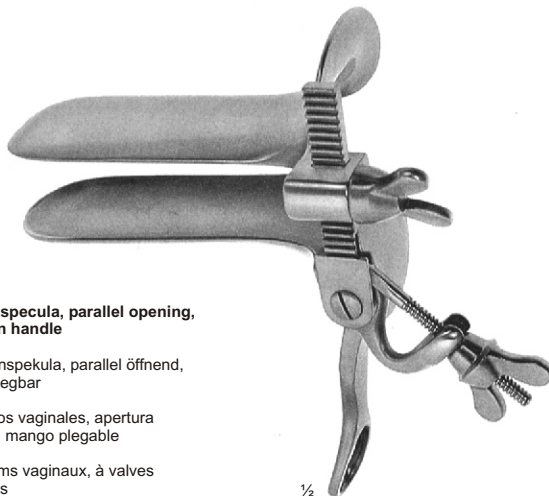

Vaginal specula, parallel opening, tilt-down handle

Scheidenspekula, parallel öffnend, Griff umlegbar

Espéculos vaginales, apertura paralela, mango plegable

Spéculums vaginaux, à valves parallèles

Speculi vaginali, apertura paralela

TRELAT

27-126-01 85 x 33 mm
27-126-02 95 x 35 mm
27-126-03 115 x 43 mm

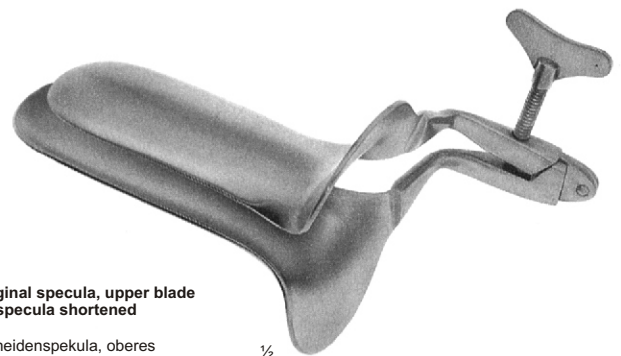

Vaginal specula, upper blade of speculum shortened

Scheidenspekula, oberes spekublatt kürzer

Espéculos vaginales, valvas superior más corta

Spéculums vaginaux, valve supérieure plus courte

Speculi vaginali, valva superiore corta

1/2

COLLIN-LANDAU

27-128-01 85 x 30 mm
27-128-02 100 x 35 mm
27-128-03 110 x 40 mm



Vaginal specula with double lock, one-hand operated

Scheidenspekula mit doppelsperre, für einhandbedienung

Espéculos vaginales con cierre doble, para el uso con una mano

spéculum vaginaux, double ouverture utilisé à la main

Speculi vaginali, a doppio fermo, impiego con una mano

SEMM

27-136-01 90 x 14 x 18 mm
27-136-02 100 x 17 x 20 mm
27-136-03 100 x 25 x 30 mm



Vaginal specula
Scheidenspekula
Espéculos vaginales
Spéculum vaginaux
speculi vaginali

½

GRAVE

27-138-01 75 x 20 mm
27-138-02 95 x 35 mm
27-138-03 115 x 35 mm



Vaginal specula
Scheidenspekula
Espéculos vaginales
Spéculum vaginaux
speculi vaginali

PEDERSON

27-144-01 75 x 13 mm
27-144-02 100 x 16 mm
27-144-03 100 x 22 mm
27-144-04 120 x 25 mm

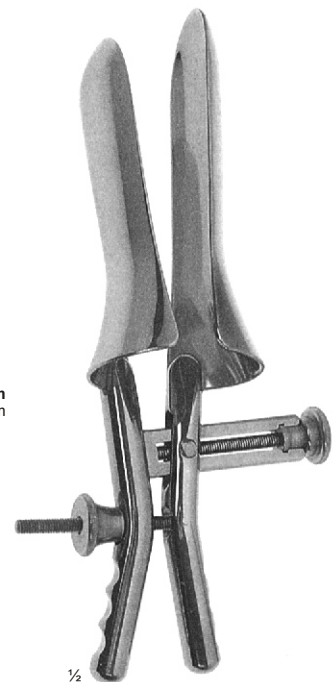

Vaginal speculum
Scheidenspekulum
Espéculo vaginal
Spéculum vaginal
speculo vaginale

½

DE VILBISS

27-148-01
102 x 32 mm



Surface black-finish
 Oberfläche geschwärzt
 Superficie negra
 Surface noire
 Superficie nera

½

PEDERSON

- 27-152-01 75 x 13 mm
- 27-152-02 100 x 22 mm
- 27-152-03 120 x 25 mm

Vaginal specula for laser surgery, suctioning from upper blade

Scheidenspekula für laserchirurgie, mit absaugung am oberen blatt

Espéculos vaginales para la cirugía con laser, tubo de succión en la valva superior

Spécuments vaginaux pour chirurgie laser, avec embout aspiration sur la valve supérieure

Speculi vaginali per chirurgia laser, aspirazione dalla valva superiore

PEDERSON

- 27-154-01 75 x 13 mm
- 27-154-02 100 x 22 mm
- 27-154-03 120 x 25 mm

Vaginal specula for laser surgery, suctioning from lower blade

Scheidenspekula für laserchirurgie, mit absaugung am unteren blatt

Espéculos vaginales para la cirugía con laser, tubo de succión en la valva inferior

Spécuments vaginaux pour chirurgie laser, avec embout aspiration sur la valve inférieure

Speculi vaginali per chirurgia laser, aspirazione dalla valva inferiore

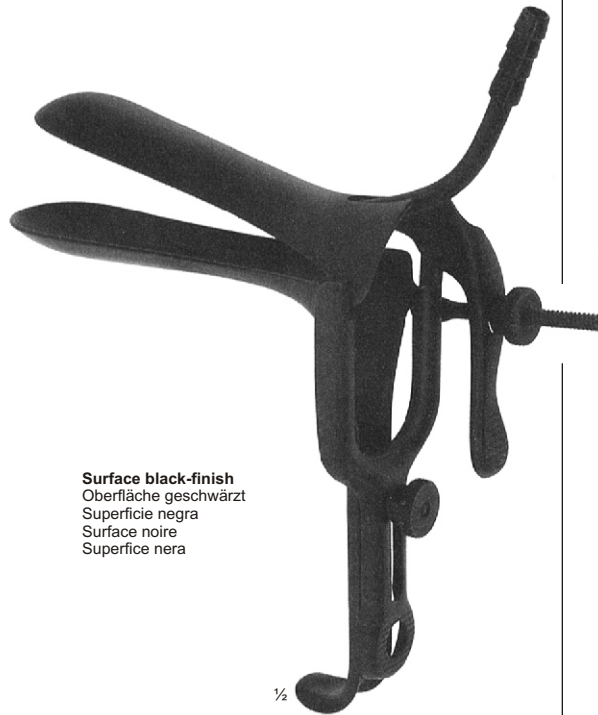

Surface black-finish
 Oberfläche geschwärzt
 Superficie negra
 Surface noire
 Superficie nera

½

GRAVE

- 27-156-01 75 x 20 mm
- 27-156-02 95 x 35 mm
- 27-156-03 115 x 35 mm

Vaginal specula for laser surgery, suctioning from upper blade

Scheidenspekula für laserchirurgie, mit absaugung am oberen blatt

Espéculos vaginales para la cirugía con laser, tubo de succión en la valva superior

Spécuments vaginaux pour chirurgie laser, avec embout aspiration sur la valve supérieure

Speculi vaginali per chirurgia laser, aspirazione dalla valva superiore

GRAVE

- 27-158-01 75 x 20 mm
- 27-158-02 95 x 35 mm
- 27-158-03 115 x 35 mm

Vaginal specula for laser surgery, suctioning from lower blade

Scheidenspekula für laserchirurgie, mit absaugung am unteren blatt

Espéculos vaginales para la cirugía con laser, tubo de succión en la valva inferior

Spécuments vaginaux pour chirurgie laser, avec embout aspiration sur la valve inférieure

Speculi vaginali per chirurgia laser, aspirazione dalla valva inferiore



⅓

KOGAN
 27-166-24
 24 cm 9½"

Endospecula for cervix and urethra
 Endospekula für Harnröhre und cervix
 Endoespéculos para cerviz y uretra
 Speculums pour urètre et col utérin
 Endospeculi per cervice ed uretra

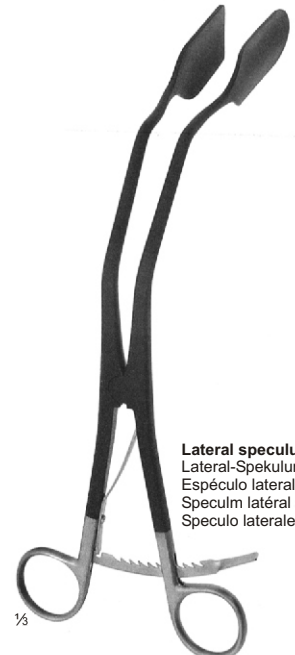

⅓

27-168-25
 25 cm 10"

Lateral speculum
 Lateral-Spekulum
 Espéculo lateral
 Speculum latéral
 Speculo laterale

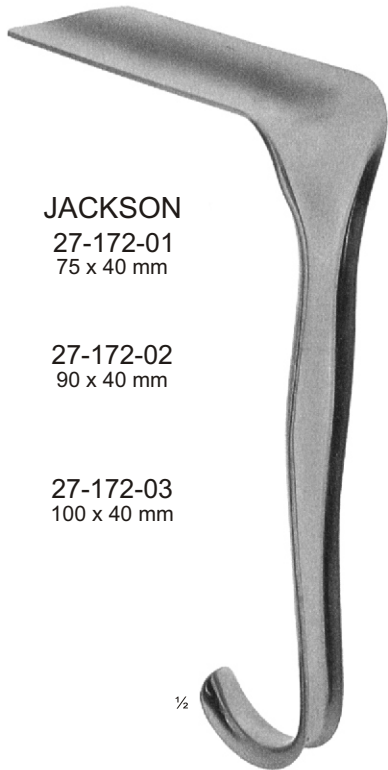

JACKSON
 27-172-01
 75 x 40 mm

27-172-02
 90 x 40 mm

27-172-03
 100 x 40 mm

½

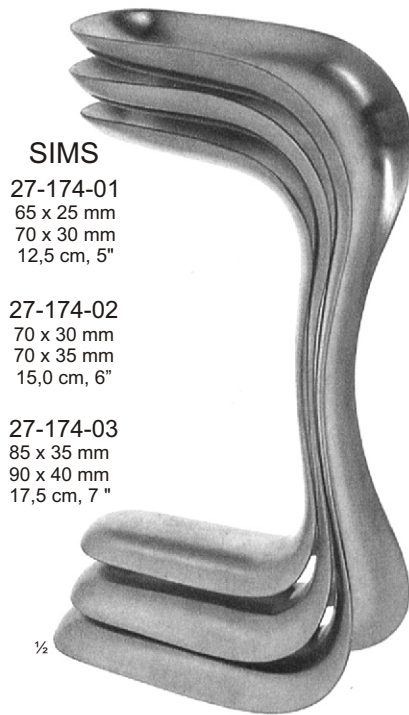

SIMS
 27-174-01
 65 x 25 mm
 70 x 30 mm
 12,5 cm, 5"

27-174-02
 70 x 30 mm
 70 x 35 mm
 15,0 cm, 6"

27-174-03
 85 x 35 mm
 90 x 40 mm
 17,5 cm, 7"

½

Vaginal specula, double-ended
 Scheidenspekula, doppelendig
 Espéculos vaginales, dobles
 Spéculums vaginaux, doubles
 Speculi vaginali, doppi

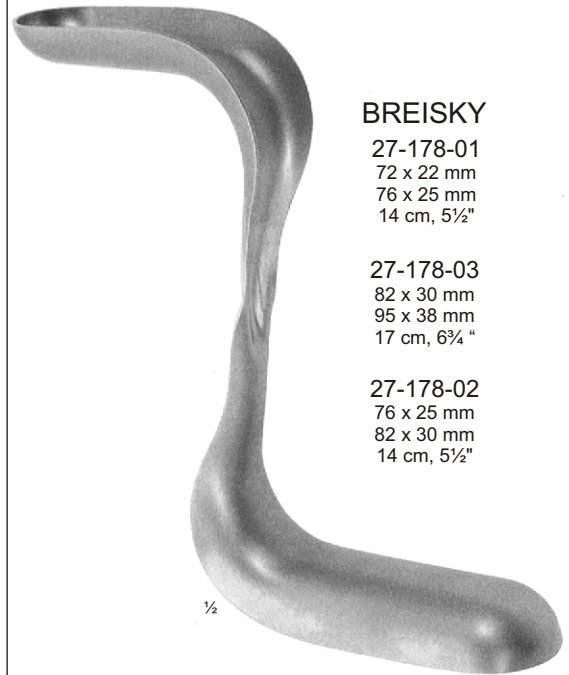

BREISKY
 27-178-01
 72 x 22 mm
 76 x 25 mm
 14 cm, 5½"

27-178-03
 82 x 30 mm
 95 x 38 mm
 17 cm, 6¾"

27-178-02
 76 x 25 mm
 82 x 30 mm
 14 cm, 5½"

½

Vaginal specula, double-ended
 Scheidenspekula, doppelendig
 Espéculos vaginales, dobles
 Spéculums vaginaux, doubles
 Speculi vaginali, doppi



KRISTELLER

27-180-01
 115 x 23 mm

27-180-02
 115 x 26 mm

27-180-03
 115 x 32 mm

½

Set of 1 speculum and 1 retractor each
 Satz aus je 1 Spekulum und 1 Halter
 Juego de 1 espéculo y 1 valva
 Jeu de 1 spéculum et 1 viave
 Set speculo e valva

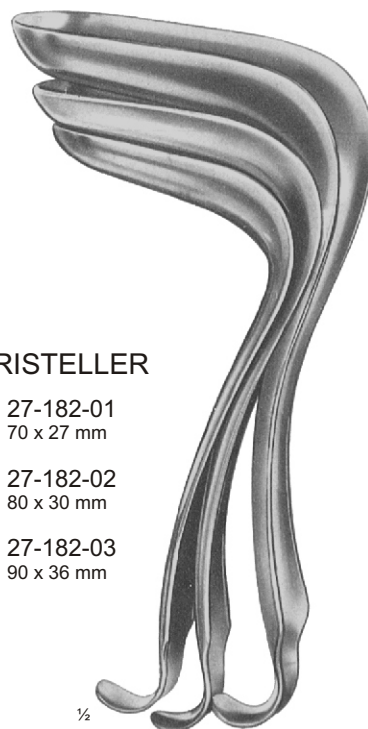

KRISTELLER

27-182-01
 70 x 27 mm

27-182-02
 80 x 30 mm

27-182-03
 90 x 36 mm

½

Specula only
 Spekula allein
 Espéculos sueltos
 Spéculums seuls
 Solo speculi



KRISTELLER

27-184-01
 75 x 23 mm

27-184-02
 85 x 26 mm

27-184-03
 100 x 32 mm

½

Retractors only
 Halter allein
 Valvas sueltas
 Valves seules
 Solo valve



Vaginal Specula and Retractors

Scheidenspekula und-halter
Espéculos y valvas vaginales
Spéculums et valves vaginaux
Speculi e valve vaginali



027



Set of 1 speculum and 1 retractor each
Satz aus je 1 Spekulum und 1 halter
Juego de 1 espéculo y 1 valva
Jeu de 1 spéculum et 1 vlave
Set speculo e valva

KRISTELLER
27-190-01
27-190-02

½

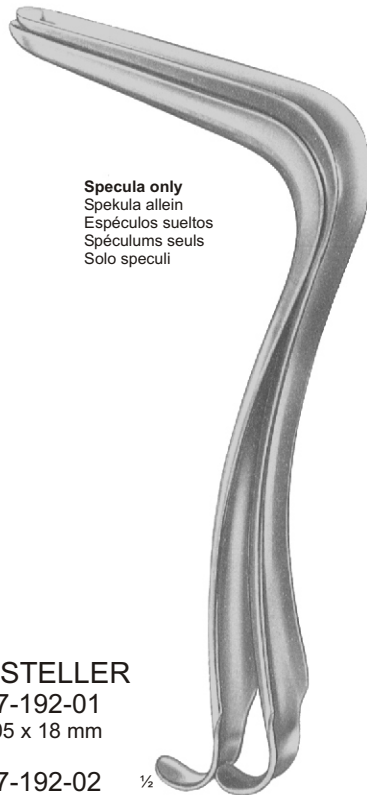

Specula only
Spekula allein
Espéculos sueltos
Spéculums seuls
Solo speculi

KRISTELLER
27-192-01
105 x 18 mm

27-192-02 ½
105 x 21 mm



Retractors only
Halter allein
Valvas sueltas
Valves seules
Solo valve

KRISTELLER
27-194-01
110 x 14 mm

27-194-02 ½
110 x 17 mm



Set of 1 speculum and 1 retractor each
Satz aus je 1 Spekulum und 1 halter
Juego de 1 espéculo y 1 valva
Jeu de 1 spéculum et 1 vlave
Set speculo e valva

KRISTELLER
27-200-01
27-200-02
27-200-03

½



Specula only
Spekula allein
Espéculos sueltos
Spéculums seuls
Solo speculi

KRISTELLER
27-202-01
105 x 26 mm

27-202-02
105 x 28 mm

27-202-03
105 x 33 mm

½

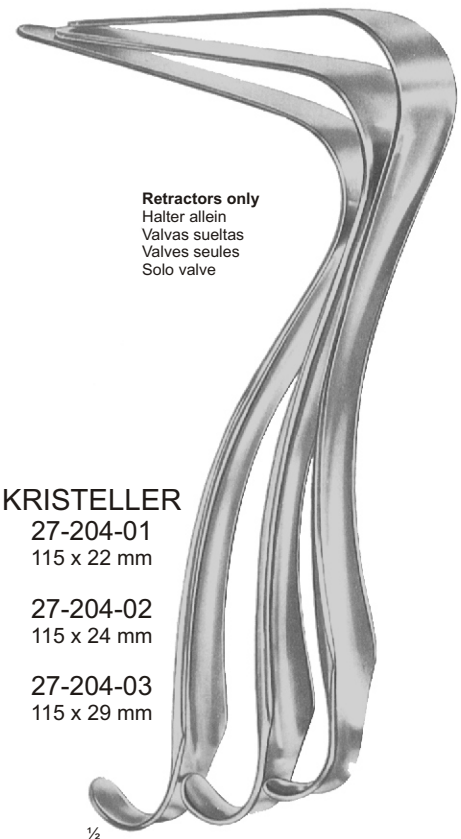

Retractors only
Halter allein
Valvas sueltas
Valves seules
Solo valve

KRISTELLER
27-204-01
115 x 22 mm

27-204-02
115 x 24 mm

27-204-03
115 x 29 mm

½



Set of 1 speculum and 1 retractor each
 Satz aus je 1 Spekulum und 1 Halter
 Juego de 1 espéculo y 1 valva
 Jeu de 1 spéculum et 1 valve
 Set speculo e valva

KRISTELLER
 27-210-01
 27-210-02
 27-210-03

½



Specula only
 Spekula allein
 Espéculos sueltos
 Spéculums seuls
 Solo speculi

KRISTELLER
 27-212-01
 110 x 27 mm
 27-212-02
 110 x 30 mm
 27-212-03
 110 x 36 mm

½



Retractors only
 Halter allein
 Valvas sueltas
 Valves seules
 Solo valve

KRISTELLER
 27-214-01
 115 x 23 mm
 27-214-02
 115 x 26 mm
 27-254-03
 115 x 32 mm

½

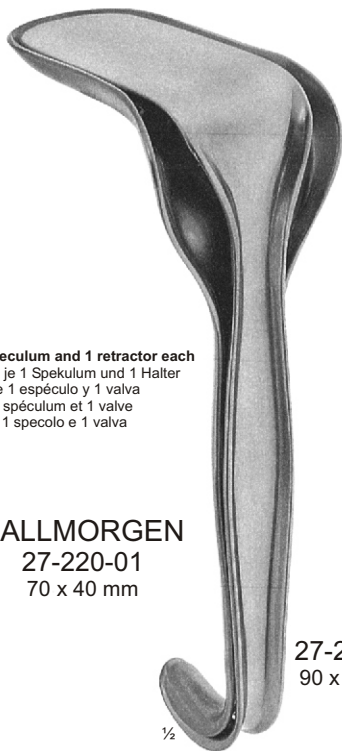

Set 1 speculum and 1 retractor each
 Satz aus je 1 Spekulum und 1 Halter
 Juego de 1 espéculo y 1 valva
 Jeu de 1 spéculum et 1 valve
 Serie da 1 specolo e 1 valva

KALLMORGEN
 27-220-01
 70 x 40 mm

27-221-02
 90 x 40 mm

½

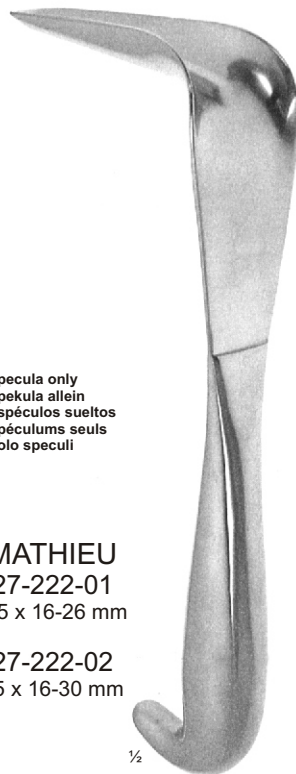

Specula only
 Spekula allein
 Espéculos sueltos
 Spéculums seuls
 Solo speculi

MATHIEU
 27-222-01
 95 x 16-26 mm
 27-222-02
 95 x 16-30 mm

½

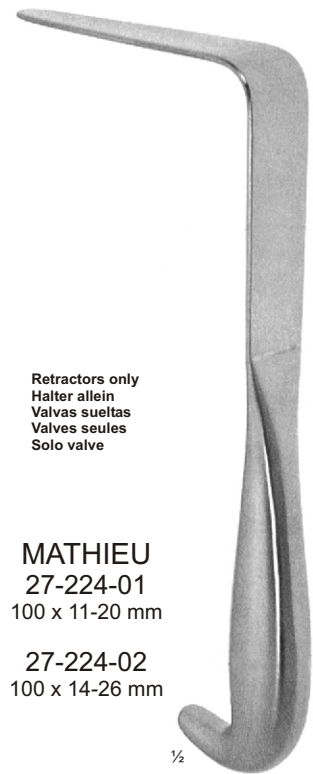

Retractors only
 Halter allein
 Valvas sueltas
 Valves seules
 Solo valve

MATHIEU
 27-224-01
 100 x 11-20 mm
 27-224-02
 100 x 14-26 mm

½

Vaginal Specula and Retractors

Scheidenspekula und-halter
Especúlos y valvas vaginales
Spéculums et valves vaginaux
Speculi e valve vaginali

Abdominal Retractors

Bauchdeckenhalter
Separadores abdominales
Ecarteurs abdominaux
Divaricatori addominali

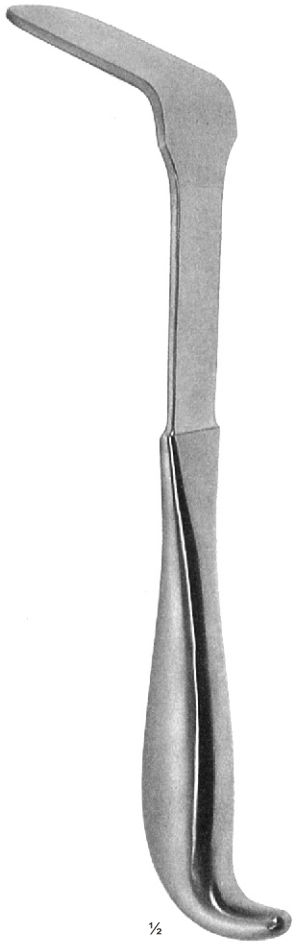
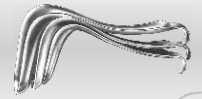

½

DOYEN

27-226-01 60 x 30 mm
27-226-02 70 x 30 mm
27-226-03 80 x 30 mm
25 cm, 10"

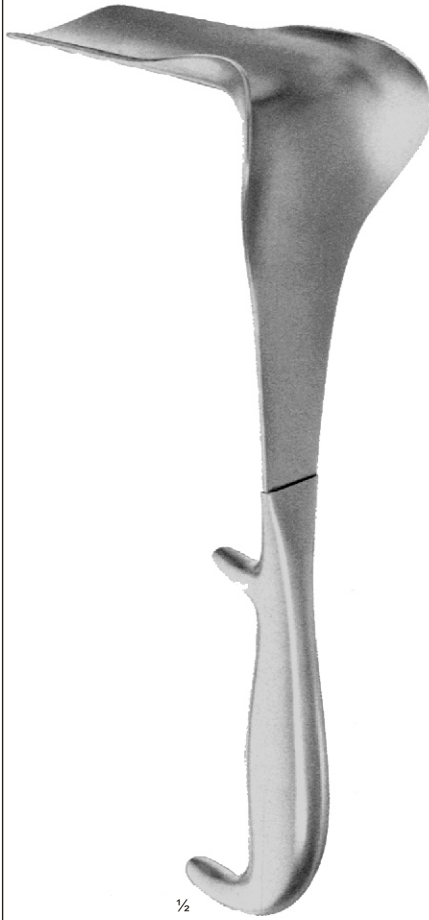

½

DOYEN

24 cm, 9½"



½

DOYEN

24 cm, 9½"

	Fig	A	B	
27-228-01	1	55mm	35mm	27-232-01
27-228-02	2	85mm	35mm	27-232-02
27-228-03	3	115mm	35mm	27-232-03
27-229-01	1	55mm	60mm	27-233-01
27-229-02	2	85mm	60mm	27-233-02
27-229-03	3	115mm	60mm	27-233-03
27-229-04	4	160mm	60mm	27-233-04
27-229-05	5	180mm	60mm	27-233-05
27-230-01	1	55mm	60mm	27-234-01
27-230-02	2	85mm	60mm	27-234-02
27-230-03	3	115mm	60mm	27-234-03
27-230-04	4	160mm	60mm	27-234-04
27-230-05	5	180mm	60mm	27-234-05

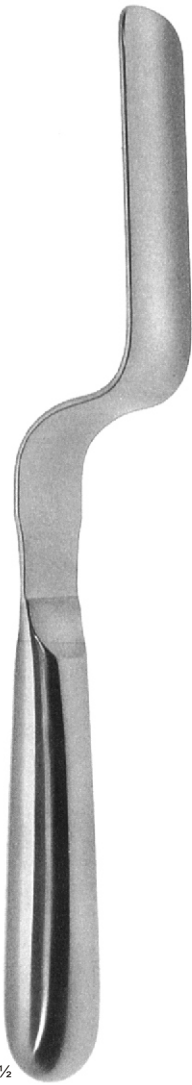
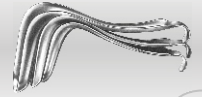

LANDAU

- 27-244-01 100 x 28 mm
- 27-244-02 105 x 38 mm



BREISKY

- 27-246-01 100 x 15 mm
- 27-246-02 100 x 20 mm
- 27-246-03 100 x 25 mm
- 27-246-04 100 x 30 mm
- 27-246-05 100 x 35 mm
- 27-246-06 100 x 40 mm
- 27-246-07 130 x 15 mm
- 27-246-08 130 x 20 mm
- 27-246-09 130 x 25 mm
- 27-246-10 130 x 30 mm
- 27-246-11 130 x 35 mm
- 27-246-12 130 x 40 mm
- 27-246-13 155 x 40 mm
- 27-246-14 180 x 40 mm



MATZENAUER

- 27-248-01 125 x 15 mm
- 27-248-02 125 x 20 mm
- 27-248-03 125 x 25 mm
- 27-248-04 125 x 30 mm
- 27-248-05 125 x 35 mm
- 27-248-06 125 x 40 mm



AUVARD

27-252-01 70 x 38 mm

27-252-02 80 x 38 mm

27-252-03 102 x 38 mm

Vaginal specula with fixed weight
 Scheidenspekula mit festem gewicht
 Espéculos vaginal con peso fijo
 Spéculums vaginal avec poids fixe
 Speculi vaginalii con peso fisso



AUVARD-BERLIND

27-254-00 70 x 38 mm

27-254-01 80 x 38 mm

27-254-02 102 x 38 mm

Vaginal speculum with fixed weight and holes in blade
 Scheidenspekulum mit festem Gewicht und löchern im blatt
 Espéculo vaginal con peso fijo y valva perforada
 Spéculum vaginal avec poids fixe et valve à trous
 Speclo vaginale con peso fisso e fori sulla lama



AUVARD

27-256-00 80 x 38 mm

27-256-01 102 x 45 mm

Vaginal speculum with detachable weight
 Scheidenspekulum mit abnehmbarem gewicht
 Espéculo vaginal con peso desmontable
 Spéculum vaginal avec poids démontable
 Speculo vaginale a peso smontabile

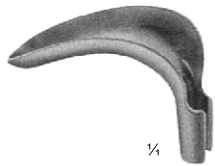

27-260-11
80 x 30 mm

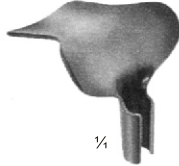

27-260-14
55 x 40-60mm

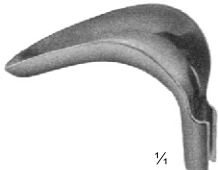

27-260-12
85 x 35 mm

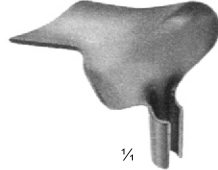

27-260-15
70 x 45-70 mm

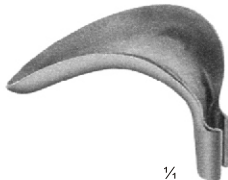

27-260-13
90 x 40 mm

Set, consisting of:
27-260-01 1 Handle
27-260-03 1 Weight 0,4 kg
27-260-11 1 Blade 80 x 30 mm
27-260-12 1 Blade 85 x 35 mm
27-260-13 1 Blade 90 x 40 mm
27-260-14 1 Blade 55 x 40-60 mm
27-260-15 1 Blade 70 x 45-70 mm

Juego, compuesto de:
27-260-01 1 Manigo
27-260-03 1 Peso 0,4 kg
27-260-11 1 Valva 80 x 30 mm
27-260-12 1 Valva 85 x 35 mm
27-260-13 1 Valva 90 x 40 mm
27-260-14 1 Valva 55 x 40-60 mm
27-260-15 1 Valva 70 x 45-70 mm

Serie, composta da:
27-260-01 1 Manico
27-260-03 1 Peso 0,4 kg
27-260-11 1 Valva 80 x 30 mm
27-260-12 1 Valva 85 x 35 mm
27-260-13 1 Valva 90 x 40 mm
27-260-14 1 Valva 55 x 40-60 mm
27-260-15 1 Valva 70 x 45-70 mm

Satz, bestehend aus:
27-260-01 1 Griff
27-260-03 1 Gewicht 0,4 kg
27-260-11 1 Blatt 80 x 30 mm
27-260-12 1 Blatt 85 x 35 mm
27-260-13 1 Blatt 90 x 40 mm
27-260-14 1 Blatt 55 x 40-60 mm
27-260-15 1 Blatt 70 x 45-70 mm

Jeu, composé de:
27-260-01 1 Manche
27-260-03 1 Poids 0,4 kg
27-260-11 1 Valve 80 x 30 mm
27-260-12 1 Valve 85 x 35 mm
27-260-13 1 Valve 90 x 40 mm
27-260-14 1 Valve 55 x 40-60 mm
27-260-15 1 Valve 70 x 45-70 mm

27-260-02
0,4kg
27-260-03
0,8kg

SCHERBAK
27-260-00

Set, Satz, Juego, Jeu, Serie



80 x 42 mm

WEISSBARTH
27-264-00
80 x 42 mm

Vaginal speculum with removable strainer and perforated bottom

Scheidenspekulum mit abnehmbarem auffangsieb

Especúlo vaginal con tamiz desmontable

Spéculum vaginal avec tamis démontable

Speculo vaginale con filtro smontabile et fondo forato

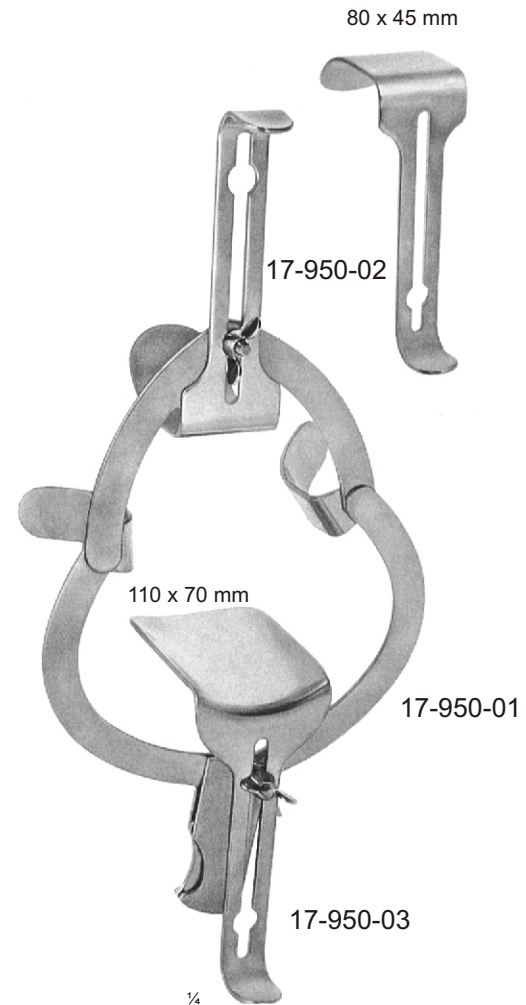

80 x 45 mm

17-950-02

110 x 70 mm

17-950-01

17-950-03

O'SULLIVAN-O'CONNOR
17-920-00

Set, Satz, Juego, Jeu, Serie

Abdominal retractor, complete, consisting of:
17-920-01 1 Frame with 2 lateral valves 62 x 25 mm
17-920-02 2 Valves 81 x 46 mm
17-920-03 1 Valve 110 x 72 mm

Bauchdeckenhalter, komplett, bestehend aus:
17-920-01 1 Rahmen mit 2 Seitenvalven 62 x 25 mm
17-920-02 2 Valven 81 x 46 mm
17-920-03 1 Valve 110 x 72 mm

Separador abdominal, completo, compuesto de:
17-920-01 1 Cuadro con 2 valvas laterales 62 x 25 mm
17-920-02 2 Valvas 81 x 46 mm
17-920-03 1 Valva 110 x 72 mm

Ecarteur abdominal, complet, composé de:
17-920-01 1 Cadre avec 2 valvas laterales 62 x 25 mm
17-920-02 2 Valves 81 x 46 mm
17-920-03 1 Valve 110 x 72 mm

Divaricatore addominale, completo, compsto da:
17-920-01 1 Telaio con valve laterali 62 x 25 mm
17-920-02 2 Valve 81 x 46 mm
17-920-03 1 Valva 110 x 72 mm



KOGAN
27-270-24
24 cm, 9½"

Endospeculum for cervix and urethra, without catch

Endospekulum für Harnröhre und Cervix, ohne Sperre

Endoespéculo para uretra y cerviz, sin cierre

Endospéculum pour urètre et col utérin, sans verrou

Endospeculo per cervice e uretra, senza cremagliera



KOGAN
27-272-24
24 cm, 9½"

Endospeculum for cervix and urethra, with scale-ratchet and fixing screws

Endospekulum für Harnröhre und Cervix, mit Skaisperre und Fixierschraube

Endoespéculo para uretra y cerviz, con cierre graduado y tornillo fijador

Endospéculum pour urètre et col utérin crémailière à vis

Endospeculo per cervice e uretra, con nottolino graduato a vite di fissaggio



KOGAN
27-274-24
24 cm, 9½"

Endospeculum for cervix and urethra, with catch

Endospekula für Harnröhre und Cervix, mit Sperre

Endoespéculos para uretra y cerviz, con cierre

Endospéculums pour urétra et col utérin, avec crémailière avec verrou

Endospeculi per cervice e uretra, con cremagliera



GOODELL
27-276-34
34 cm, 13½"

Uterine dilator

Uterus-Dilatator
Dilatador uterino
Dilatateur du col de l'utérus
Dilatatore uterino



½

SIMS
 27-280-32
 32 cm, 12½"

Graduated in inch, malleable, silver-plated

mit Zolleinteilung, biegsam versilbert

Graduado en pulgadas, maleable, plateado

Gradué en pouces, malléable, argent

Graduato in poillice, malleabile, placcato in argento



½

SIMS
 27-282-32
 32 cm, 12½"

Graduated in centimeters, malleable, silver-plated

mit Zolleinteilung, biegsam versilbert

Graduado en centimetros, maleable, plateado

Gradué en cm, malléable, argent

Graduato in cm, malleabile, placcato in argento



½

SIMS
 27-286-32
 32 cm, 12½"

Graduated in centimeters, malleable, 18/8 steel

mit Zolleinteilung, biegsam 18/8 Stahl

Graduado en centimetros, maleable, acero 18/18

Gradué en cm, malléable, acier inox

Graduato in cm, malleabile, acciaio inox 18/8



½

SIMPSON
 27-288-34
 34 cm, 13½"

Graduated in centimeters, malleable, silver-plated

Mit Zentimetereinteilung, biegsam, versilbert

Graduo en centimetros, maleable, plateado

gradué en cm, malleable, argent

Graduto in cm, malleabile, placcato in argento



½

VALLEIX
 27-294-25
 25 cm, 10"

Graduated in centimeters, with slider, malleable, Chromium plated

mit Zolleinteilung, und schieber, biegsam, verchromt

Graduado en centimetros, con un cursor, maleable, cromado

Gradué en cm avec curseur, malléable, chromé

Graduato in cm, com cursore, malleabile, cromato

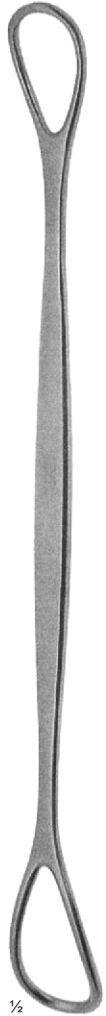

BRAUN
 27-300-28
 28 cm, 11"

Uterine depressor
 Uterus-Depressor
 Depresor uterino
 Dépresseur utérin
 Depressori uterini

Uterine gauze packer
 Tamponadeführer
 Conductor de tampónes
 Conducteur porte-tampon
 Porta garzaa uterino

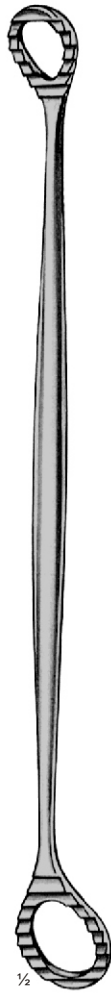

SIMS
 27-304-26
 26 cm, 10¼"

Uterine depressor
 Uterus-Depressor
 Depresor uterino
 Dépresseur utérin
 Depressori uterini

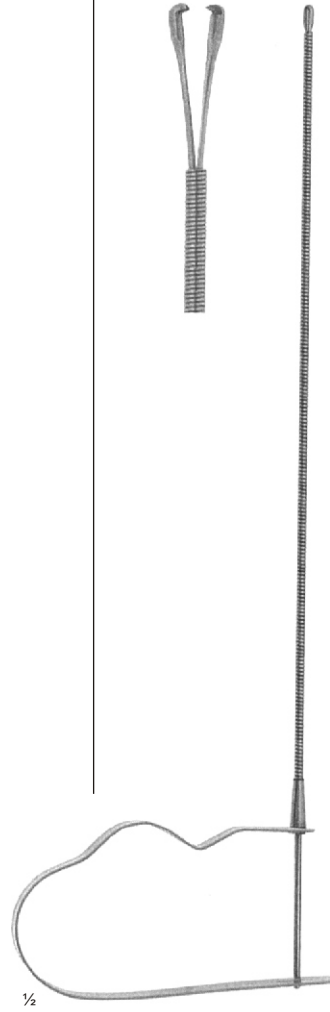

27-306-01 3 mm x 220 mm
 27-306-02 3 mm x 285 mm

IUD (Intra Uterine Device)- Forceps with flexible shaft
 IUP (Intrauterinpessar)- Faßzangen mit flexiblem Schaft
 Pinzas DIU (Dispositivo Intra-Uterino) con vástago flexible
 Pince-DIU tige flexible
 Pinza intra-uterina con asta flessibile

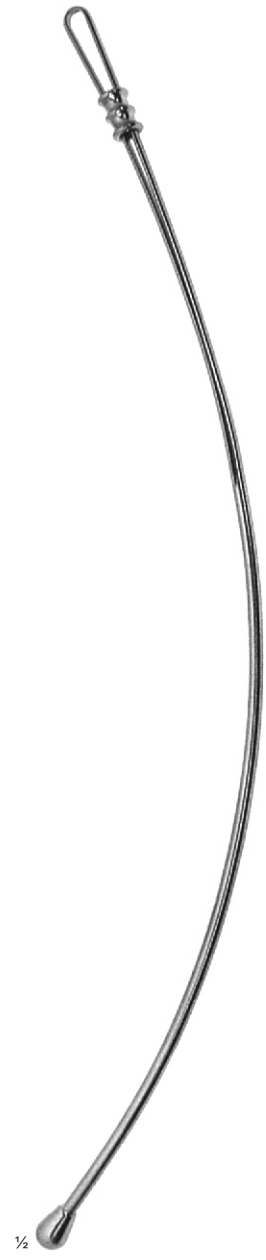

AMANN
 27-310-32
 32 cm, 12½"

Uterine gauze packer
 Tamponadeführer
 Conductor de tapónes
 Conducteur porte-tampon
 Porta garza uterino



½

HEGAR

- 27-322-01 Ø 1,0 mm
 - 27-322-02 Ø 2,0 mm
 - 27-322-03 Ø 3,0 mm
 - 27-322-04 Ø 4,0 mm
 - 27-322-05 Ø 5,0 mm
 - 27-322-06 Ø 6,0 mm
 - 27-322-07 Ø 7,0 mm
 - 27-322-08 Ø 8,0 mm
 - 27-322-09 Ø 9,0 mm
 - 27-322-10 Ø 10,0 mm
 - 27-322-11 Ø 11,0 mm
 - 27-322-12 Ø 12,0 mm
 - 27-322-13 Ø 13,0 mm
 - 27-322-14 Ø 14,0 mm
 - 27-322-15 Ø 15,0 mm
 - 27-322-16 Ø 16,0 mm
 - 27-322-17 Ø 17,0 mm
 - 27-322-18 Ø 18,0 mm
 - 27-322-19 Ø 19,0 mm
 - 27-322-20 Ø 20,0 mm
 - 27-322-21 Ø 21,0 mm
 - 27-322-22 Ø 22,0 mm
 - 27-322-23 Ø 23,0 mm
 - 27-322-24 Ø 24,0 mm
 - 27-322-25 Ø 25,0 mm
 - 27-322-26 Ø 26,0 mm
- 18,5 cm, 7¼"

With sloped handle
 Mit glattem Muldengriff
 con mango aplanado
 á manche aplati
 con manico iclinato



½

HEGAR

- 27-323-01 Ø 1,5 mm
 - 27-323-02 Ø 2,5 mm
 - 27-323-03 Ø 3,5 mm
 - 27-323-04 Ø 4,5 mm
 - 27-323-05 Ø 5,5 mm
 - 27-323-06 Ø 6,5 mm
 - 27-323-07 Ø 7,5 mm
 - 27-323-08 Ø 8,5 mm
 - 27-323-09 Ø 9,5 mm
 - 27-323-10 Ø 10,5 mm
 - 27-323-11 Ø 11,5 mm
 - 27-323-12 Ø 12,5 mm
 - 27-323-13 Ø 13,5 mm
 - 27-323-14 Ø 14,5 mm
 - 27-323-15 Ø 15,5 mm
 - 27-323-16 Ø 16,5 mm
 - 27-323-17 Ø 17,5 mm
- 18,5 cm, 7¼"

With sloped handle
 Mit glattem Muldengriff
 con mango aplanado
 á manche aplati
 con manico iclinato



HEGAR
 27-330-00



HEGAR
 27-330-01

Set in metal case
 Satz in Metalltui
 Juego en estuche de metal
 jeu en boîte métallique
 Serie in scatola metallica

Pieces per set	set	
Stück per Satz	Satz	
Piezas por juego	juego	
Pièces par jeu	jeu	
Pezzi per serie	serie	
14	4,0-17,0 mm	27-330-00
26	1,0-26,0 mm	27-330-01

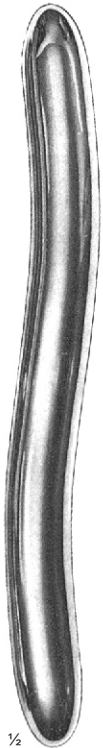

1/2

23-336-02

HEGAR

- 27-336-02 Ø 1/2 mm
- 27-336-03 Ø 2/3 mm
- 27-336-04 Ø 3/4 mm
- 27-336-06 Ø 5/6 mm
- 27-336-08 Ø 7/8 mm
- 27-336-10 Ø 9/10 mm
- 27-336-12 Ø 11/12 mm
- 27-336-14 Ø 13/14 mm
- 27-336-16 Ø 15/16 mm
- 27-336-18 Ø 17/18 mm
- 27-336-20 Ø 19/20 mm
- 27-336-22 Ø 21/22 mm
- 27-336-24 Ø 23/24 mm
- 27-336-26 Ø 25/26 mm

20 cm, 8"



HEGAR
 27-338-00

Dilator set, consisting of:
 27-336-04_27-336-18 8 Dilators Ø 3/4-17/18 mm
 27-338-01 1 Boilable canvas roll

Dilatatoren-Satz, bestehend aus:
 27-336-04_27-336-18 8 Dilatoren Ø 3/4-17/18 mm
 27-338-01 1 auskochbare Segeltuchrolle

Juego de dilatadores, compuesto de:
 27-336-04_27-336-18 8 Dilatadores de Ø 3/4-17/18 mm
 27-338-01 1 Bolsa de tela esterilizable por ebullición

Jeu de dilateurs, composé de:
 27-336-04_27-336-18 8 Dilateurs de Ø 3/4-17/18 mm
 27-338-01 1 Trouse stérilisable par ébullition

Set dilatori, composto da:
 27-336-04_27-336-18 8 Dilatatori Ø 3/4-17/18 mm
 27-338-01 1 Borsa telata sterilizzabile

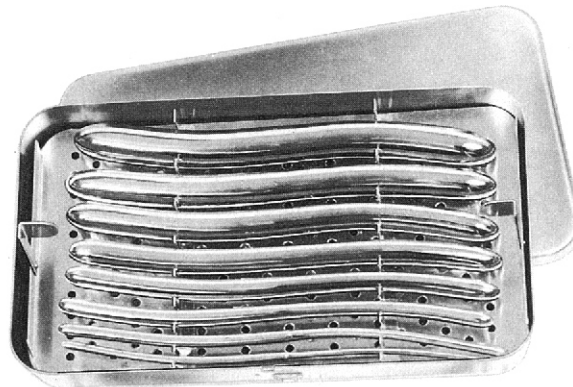

27-340-00



27-340-01

Set in metal case
 Satz in Metalltui
 Juego en estuche de metal
 jeu en boîte métallique
 Serie in scatola metallica

Pieces per set	set	
Stück per Satz	Satz	
Piezas por juego	juego	
Pièces par jeu	jeu	
Pezzi per serie	serie	

14	4,0-17,0 mm	27-340-00
26	1,0-26,0 mm	27-340-01



HANK

- 27-340-05 Ø 4,5/ 5,0 mm
- 27-340-06 Ø 5,5/ 6,0 mm
- 27-340-07 Ø 6,5/ 7,0 mm
- 27-340-08 Ø 7,5/ 8,0 mm
- 27-340-09 Ø 8,5/ 9,0 mm
- 27-340-10 Ø 9,5/ 10,0 mm

Set , Satz , Juego , Jeu , Serie

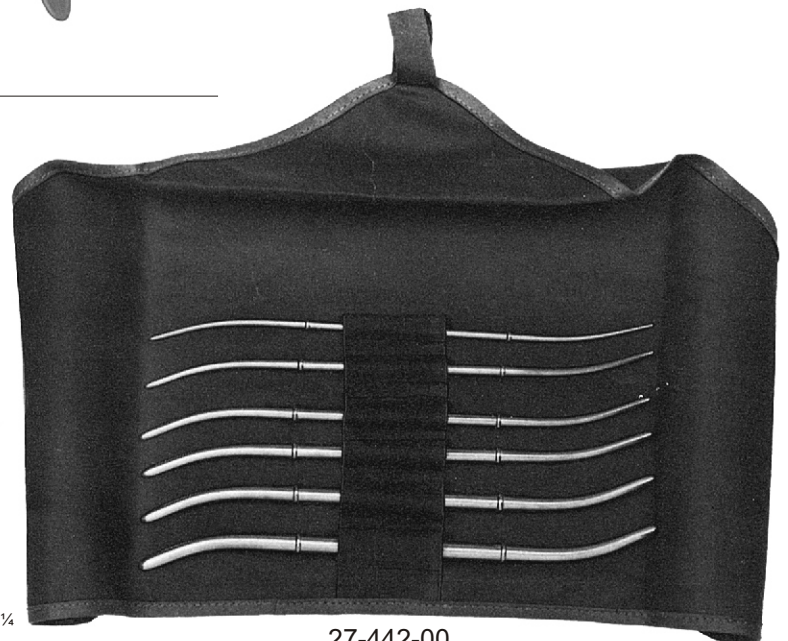

27-442-00

Set , Satz , Juego , Jeu , Serie

Uterine Tenaculum Forceps

Hakenzangen

Pinzas para coger el cuello del útero

Pinces pour abaissement du col de l'utérus

Pinze per abbassare il collo dell'utero



BERNHARD
27-350-16
16 cm, 6¼"



STAUDE-MOORE
27-352-17
17 cm, 6¾"



ADAIR
27-354-18
18 cm, 7"

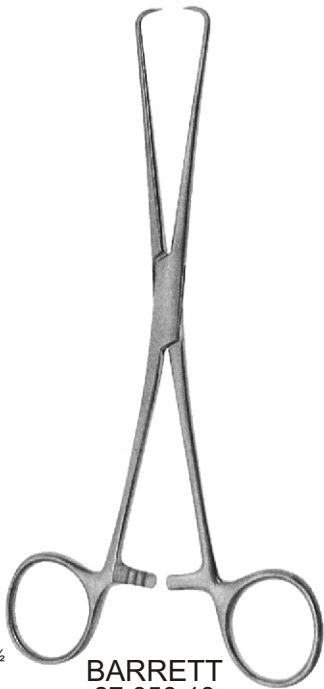

BARRETT
27-356-18
18 cm, 7"

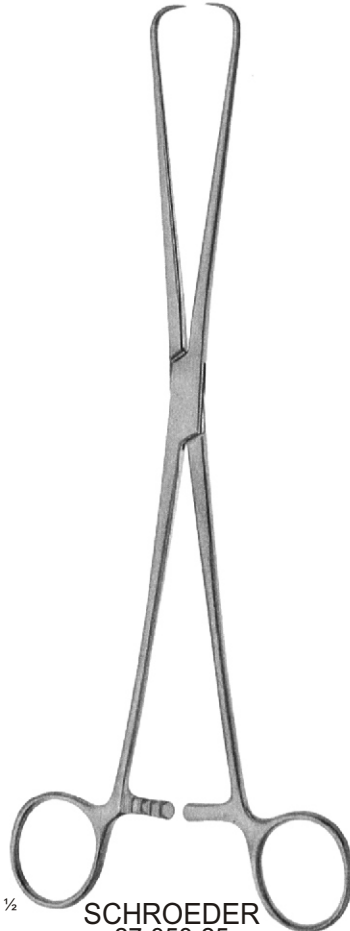

SCHROEDER
27-358-25
25 cm, 10"

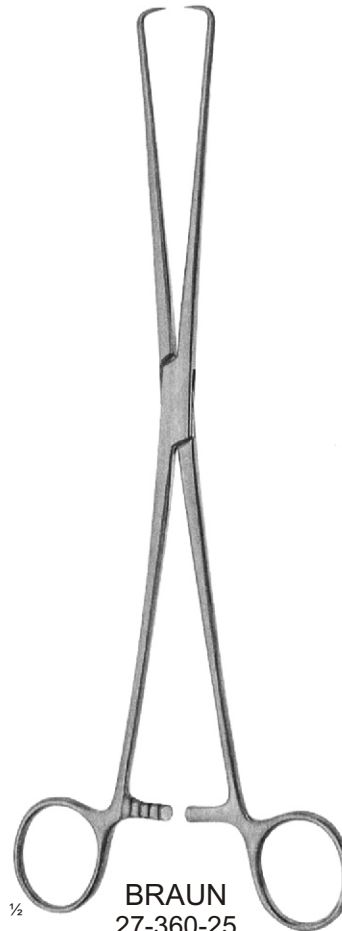

BRAUN
27-360-25
25 cm, 10"



BEACHAM
29-366-26
26 cm, 10¼"

Amniotome for the amnion bladder

Amniotom für die Amnionblase

Amniótomo para la vejiga amniótica

Amniotome pour le liquide amniotique

Amniotomo per la vescica amniotica

Uterine Tenaculum Forceps

Hakenzangen

Pinzas para coger el cuello del útero

Pinces pour abaissement du col de l'utérus

Pinze per abbassare il collo dell'utero



1/2

POZZI
27-370-25
25,5 cm, 10"

Heavy Pattern
Kräftiges Modell
Modelo fuerte
Modèle fort
Modello pesante

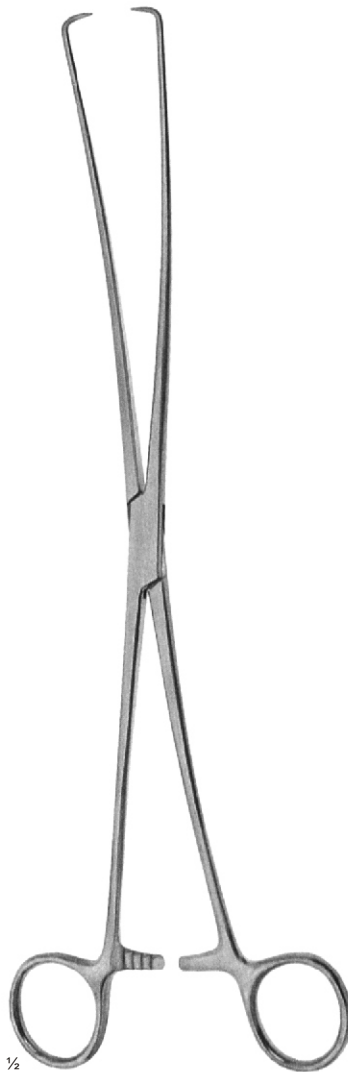

1/2

DUPLAY
27-373-28
28 cm, 11"



1/2

SCHRODER
27-374-25
25,5 cm, 10"



1/2

SKENE
27-379-24
24 cm, 9 1/4"

Uterine Tenaculum Forceps

Hakenzengen

Pinzas para coger el cuello del útero

Pinces pour abaissement du col de l'utérus

Pinze per abbassare il collo dell'utero



LAHEY
27-380-15
15 cm, 6"
27-380-20
20 cm, 8"

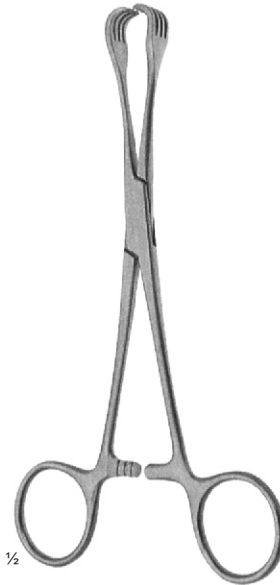

BRAUN
27-382-15
15,5 cm, 6¼"



CZERNY
27-386-20
20,5 cm, 8¼"

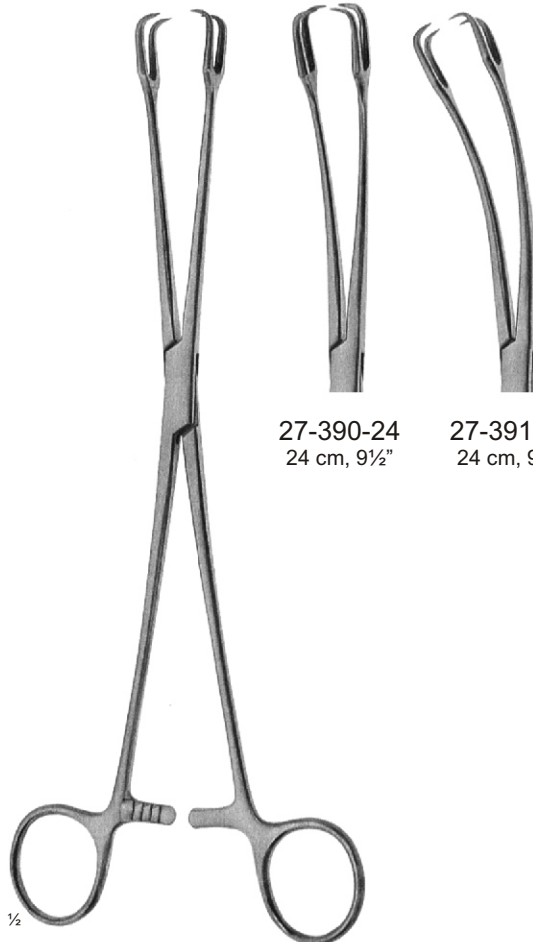

SCHROEDER
27-390-24
27-391-24

27-390-24
24 cm, 9½"

27-391-24
24 cm, 9½"



PRATT
27-398-26
26 cm, 10¼"

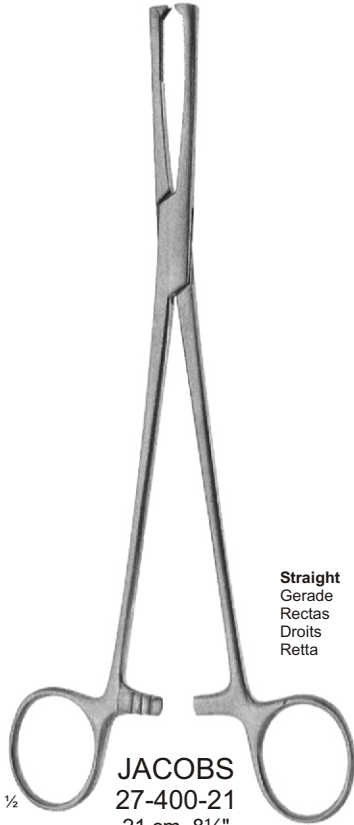

Straight
 Gerade
 Rectas
 Droits
 Retta

JACOBS
 27-400-21
 21 cm, 8¼"

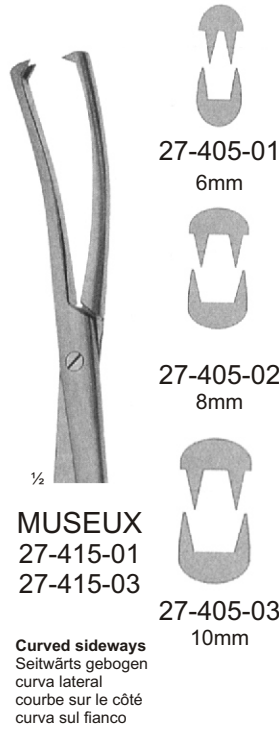

27-405-01
 6mm

27-405-02
 8mm

27-405-03
 10mm

MUSEUX
 27-415-01
 27-415-03

Curved sideways
 Seitwärts gebogen
 curva lateral
 courbe sur le côté
 curva sul fianco



IOWA
 27-413-26
 26 cm, 10¼"

Membrane puncturing forceps, 5x6 teeth
 Blasensprenger, 5x6 Zähne
 Pinza para la vejiga amniótica 5x6 dientes
 Pince perce membrane, 5x6 dents
 Pinza per puntura amniotica, 5x6 denti



27-413-01
 23 cm, 9"

27-413-02
 23 cm, 9"

Curved sideways
 Seitwärts gebogen
 Curva lateral
 Courbe sur le côté
 Curva sul fianco

TEALE
 27-413-01
 27-413-02

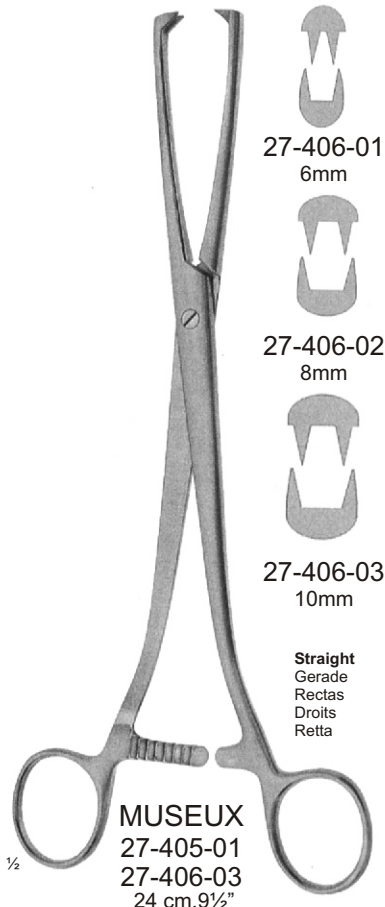

27-406-01
 6mm

27-406-02
 8mm

27-406-03
 10mm

Straight
 Gerade
 Rectas
 Droits
 Retta

MUSEUX
 27-405-01
 27-406-03
 24 cm, 9½"

Dressing and Sponge Holding Forceps

Tupfer- und Schwammzangen
 Pinzas para torundas y esponjas
 Pincas à tampons et éponges
 Pinze per tamponi e spugne

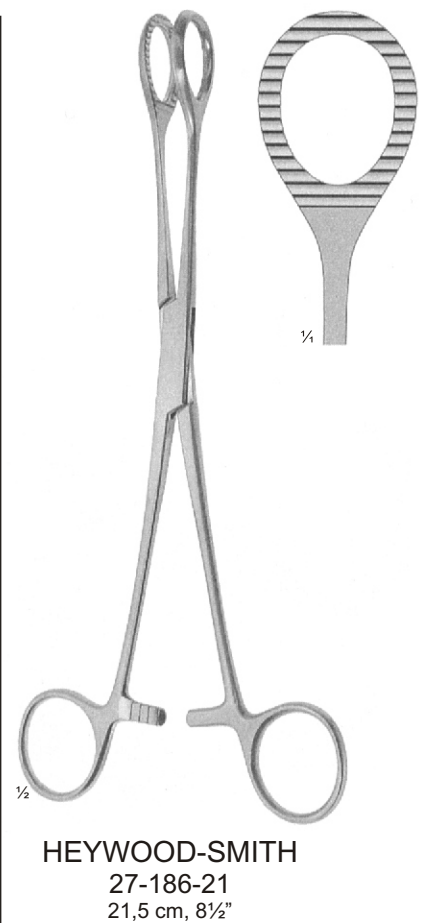
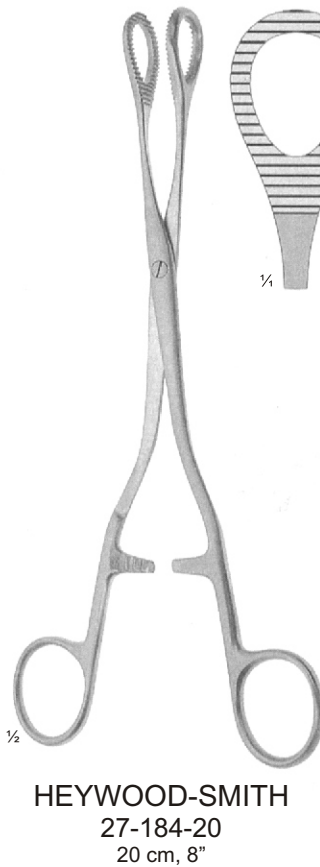
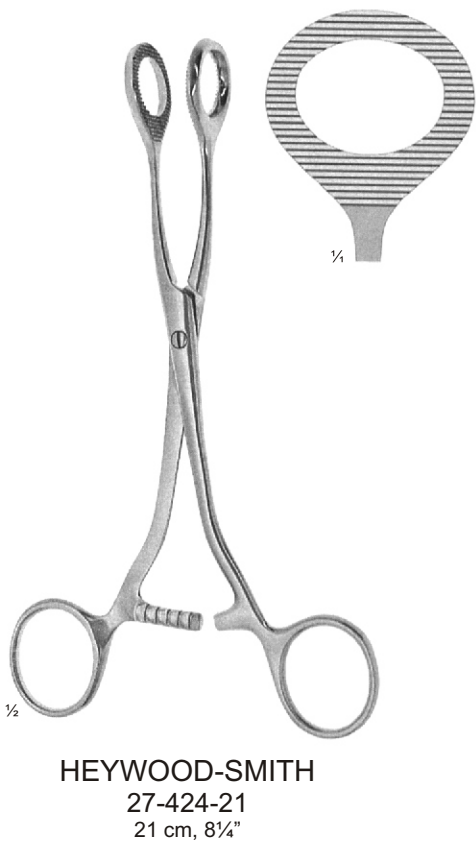
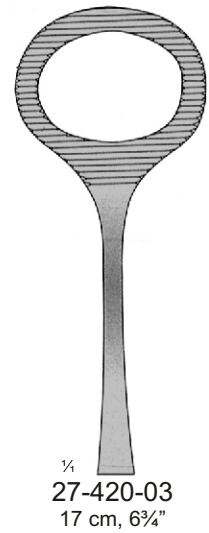
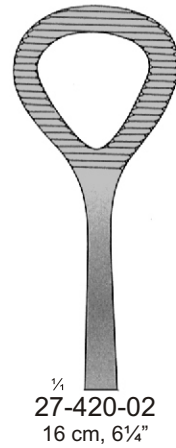
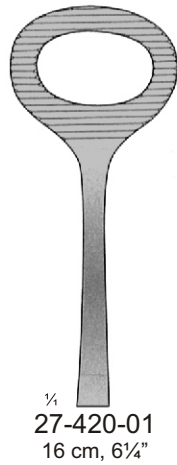

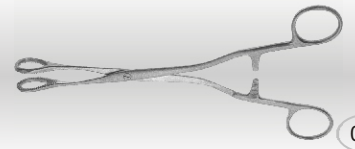

NOTO
 27-430-20
 20 cm, 8"



HEYWOOD-SMITH
 27-432-27
 27 cm, 10½"

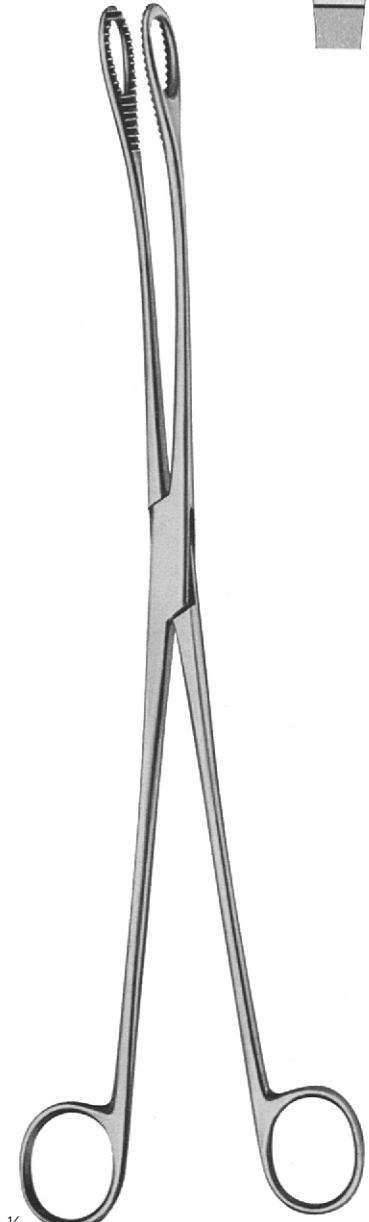

KELLY
 27-436-32
 32 cm, 12½"

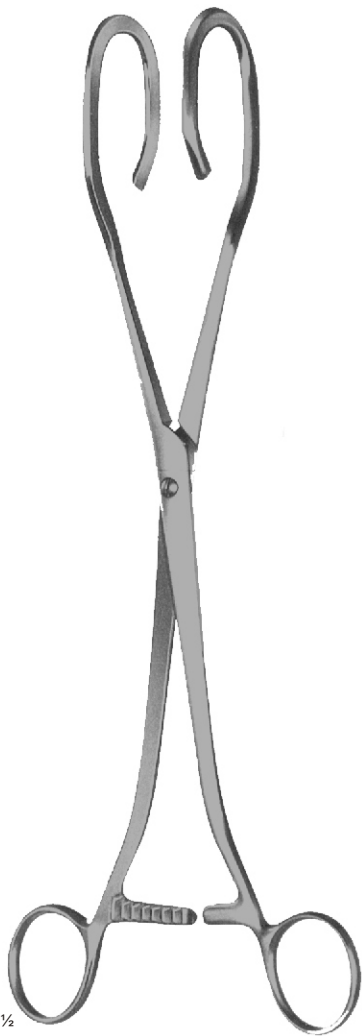
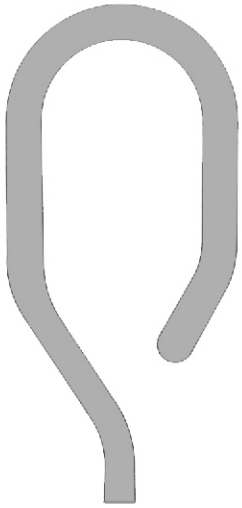
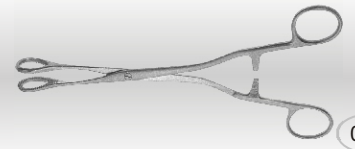

½

DARTIGVES
 27-450-27
 27 cm, 10½"

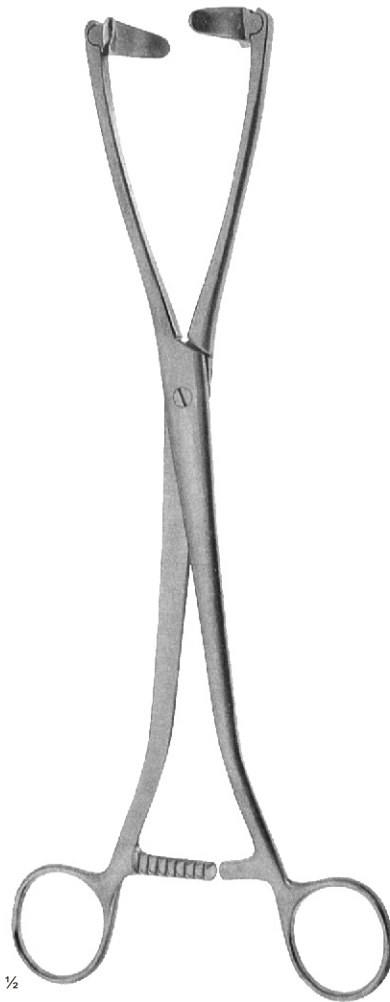
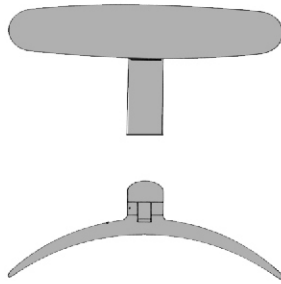

½

COLLIN
 27-454-25
 25 cm, 10"

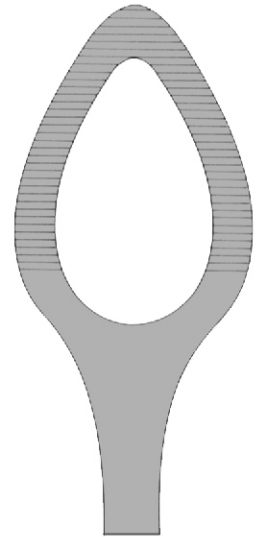

½

SOMER
 27-458-23
 23 cm, 9"

Spone and Dressing Forceps

Kourn-und Tupferzangen

Pinzas para vendajes y torundas

Pinces à pansements et tampons

Pinze per medicatura e tamponi

Biopsy Curettes

Biopsieküretten

Curetas para biopsía

Curettes pour biopsie

Curette per biopsia

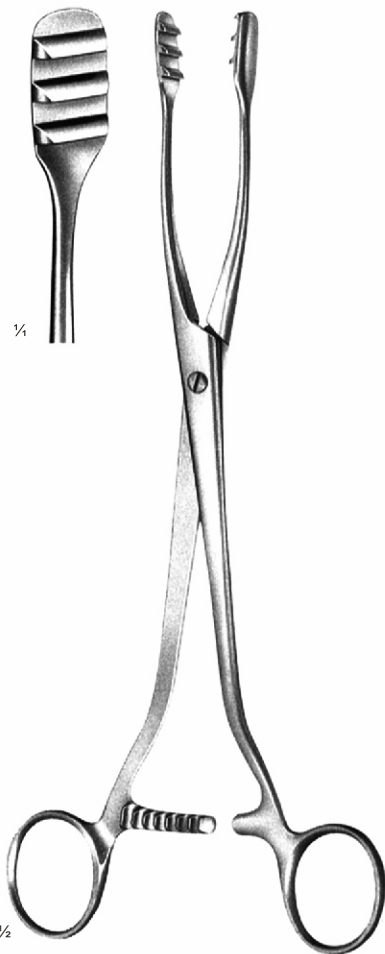

COLLIN
27-484-25
25 cm, 10"



COLLIN
27-488-28
28,5 cm, 11¼"

Endometrial suction biopsy curette

Endometrium-Saugbiopsiekürette

Cureta aspiradora par biopsia endo-uterina

Curette aspiratrice pour biopsie de l'endomètre

Curetta aspirante per la biopsia dell'endometrio

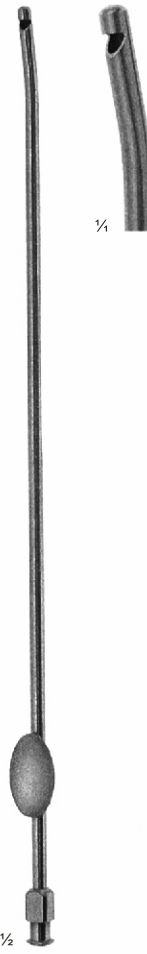

RANDALL
27-490-24
24 cm, 9½"

Endometrial suction biopsy curette

Endometrial-Saugbiopsiekürette

Cureta aspiradora par biopsia endo-uterina

Curette aspiratrice pour biopsie de l'endomètre

Curetta aspirante per la biopsia dell'endometrio

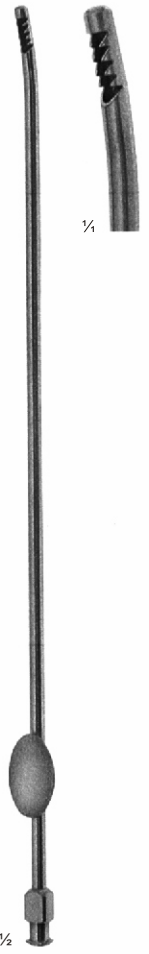

NOVAK
27-492-23
23 cm, 9"



DOYEN
27-494-14
14 cm, 5½"

Myoma screw Ø 20 mm
Mayomheber Ø 20 mm
Tirabuzón para mioma Ø 20 mm
Tracteur pour fibrome Ø 20 mm
Succhiello per fibroma Ø 20 mm



DOYEN
27-494-17
17 cm, 6¾"

Myoma screw Ø 29 mm
Mayomheber Ø 29 mm
Tirabuzón para mioma Ø 29 mm
Tracteur pour fibrome Ø 29 mm
Succhiello per fibroma Ø 29 mm



SIMON
27-495-22
22 cm, 8¾"



SIMON
27-496-22
22 cm, 8¾"



SEGOND
27-497-27
27 cm, 10¾"



AYRE
27-499-23
23 cm, 9"

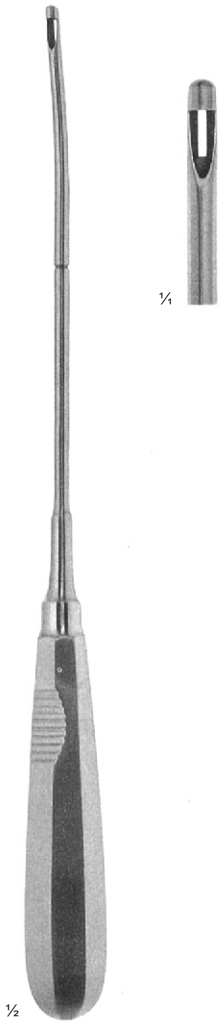

MOD-MUNCHEN
 27-500-27
 27 cm, 10½"

Endometrial biopsy curette
 Endometriumstrichkürette
 Cureta para biopsia endo-uterina
 Curette à biopsie de l'endometre
 Curetta per la biopsia dell'endometrio

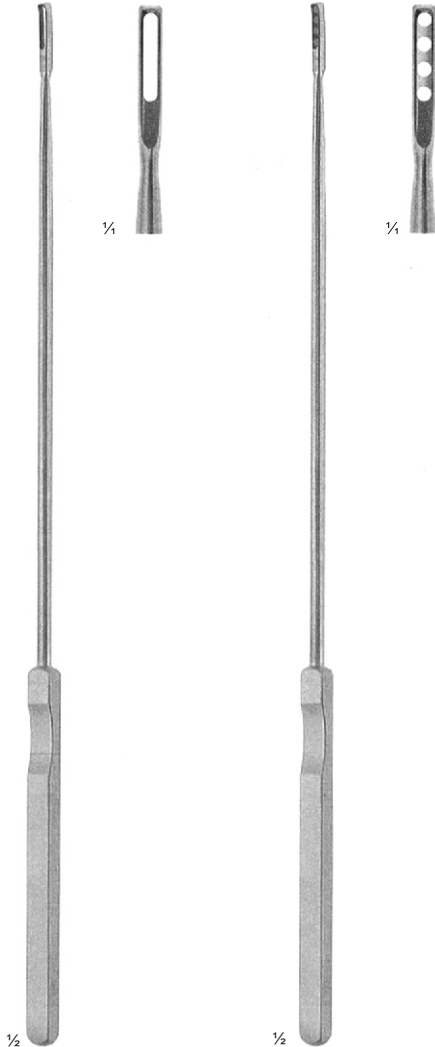

KEVOURKIAN YOUNGE
 27-502-01
 30 cm, 12"

Endocervical biopsy curette
 Endocervixbiopsiekürette
 Cureta para biopsia endo-cerviz
 Curette à biopsie endocervicale
 Curetta per la biopsia endo-cervicale

KEVOURKIAN YOUNGE
 27-502-02
 30 cm, 12"



MILLIN
 27-510-01
 27-512-03

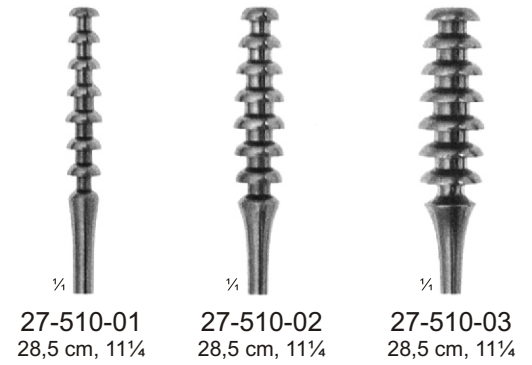

27-510-01
 28,5 cm, 11¼"

27-510-02
 28,5 cm, 11¼"

27-510-03
 28,5 cm, 11¼"

Malleable
 Biegsam
 Maleables
 Malleables
 Malleabili

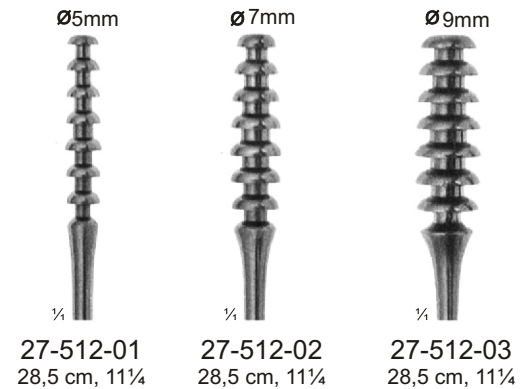

27-512-01
 28,5 cm, 11¼"

27-512-02
 28,5 cm, 11¼"

27-512-03
 28,5 cm, 11¼"

Rigid
 Starr
 Rígidas
 Rigides
 Rigidi

Endocervical biopsy curettes, working portion consisting of several concave-shaped circular knives, arranged one beneath the other

Endocervix-Biopsieküretten, Arbeitsteil bestehend aus mehreren, untereinander angeordneten konkaven rundmessern

Cureta para biopsia endo-cerviz, con cuchillitos redondos colocados uno sobre otro, concavos

Curettes pour biopsie endo-cervicale constituées de plusieurs parties tranchantes circulaires concaves

Curette per la biopsia endo-cervicale, con parte attiva formata da dischi, taglianti concavi sistemati l'uno sull'altro



27-525-21
 21 cm, 8¼"



FAURE
 27-525-21
 21 cm, 8¼"

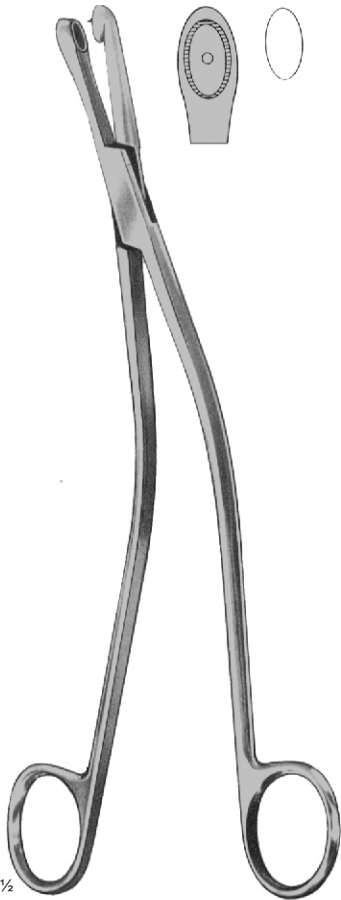

GELLHORN
 27-521-23
 23 cm, 9"



SCHUBERT
 27-528-21
 27-528-29

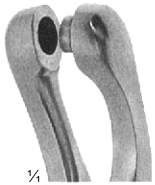
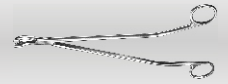

¼

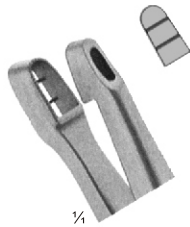

¼



¼



¼



½

THOMAS-GAYLOR
 27-531-24
 24 cm, 9½"

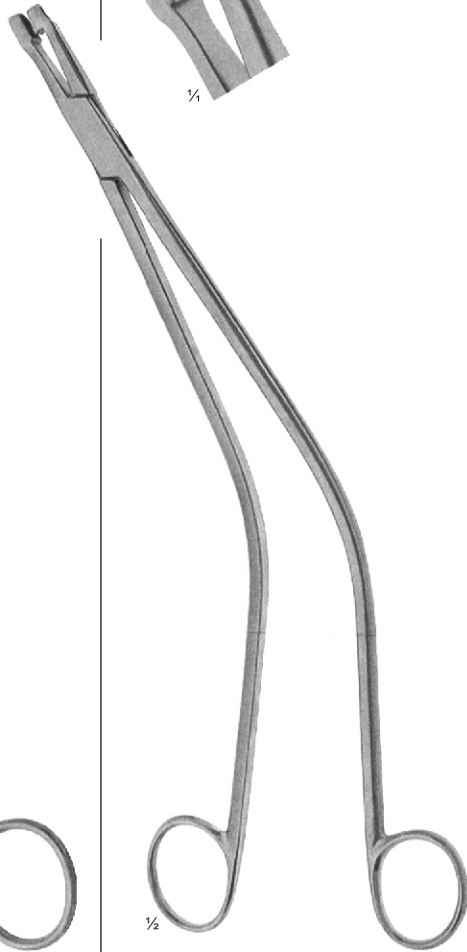

½

SCHUBERT
 27-535-26
 26 cm, 10¼"

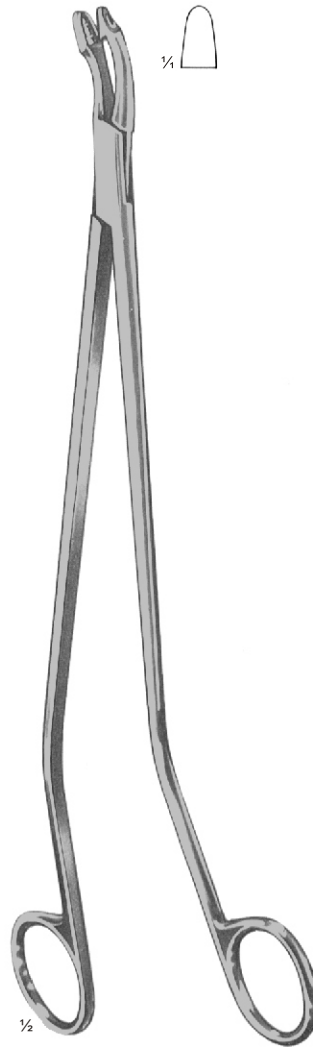

½

VAN-DOREN
 27-537-24
 24 cm, 9½"

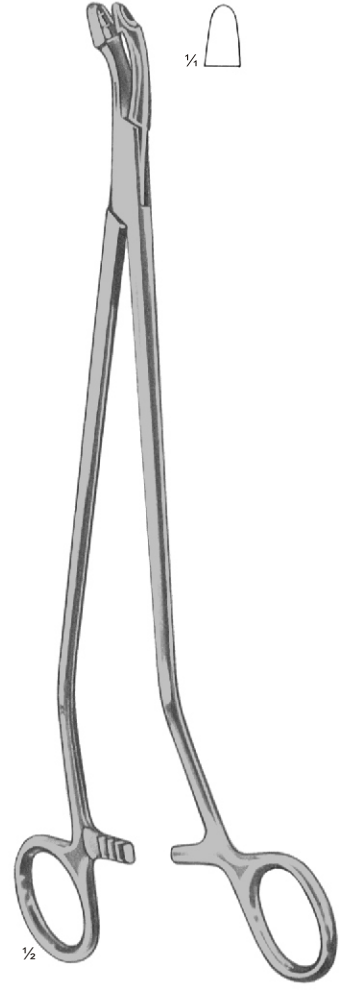

½

VAN-DOREN
 27-539-25
 25 cm, 10"

Cervical biopsy and specimen forceps
 Uterus-Biopsiezange
 Pinza saca-bocados para biopsia
 Pince emporte-pièces à biopsie
 Pinza per la biopsia cervicale e da prelievo

Cervical Biopsy and Specimen Forceps

Uterus-Biopsiezangen

Pinzas saca-bocados para biopsia

Pinces emporte-pièces à biopsie

Pinze per la biopsia cervicale e da prelievo

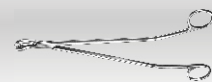

027



TISCHLER
27-543-27
27 cm, 10 $\frac{3}{4}$ "



SCHUMACHER-VAN DOREN
27-547-01
27-547-02
24 cm, 9 $\frac{1}{2}$ "



SEIDL DBP
27-551-01
27-551-03

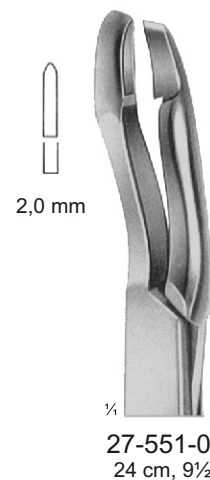

27-551-01
24 cm, 9 $\frac{1}{2}$ "

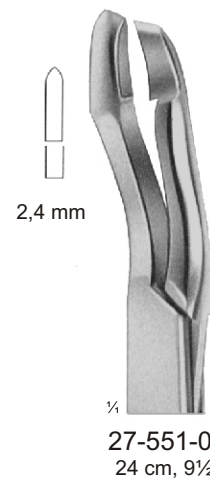

27-551-02
24 cm, 9 $\frac{1}{2}$ "

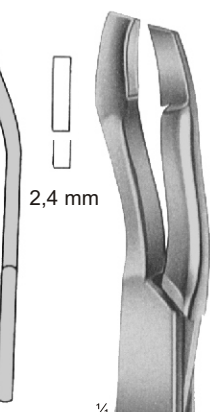

27-551-03
24 cm, 9 $\frac{1}{2}$ "



20 cm 8"

Jaws curved to left, with steady cut
 Maul nach links gebogen, mit ziehendem Schnitt
 boca curva hacia la izquierda, con corte constante
 Mors courbes à gauche, avec coupe constante
 morsi curvi a sinistra, a taglio fisso

27-570-20 20 cm, 8"
 27-570-28 28 cm, 11"

ALEXANDER
 27-570-20
 27-570-28

24,5 cm 9 1/4"

27-574-23 23 cm, 9"
 27-574-25 25 cm, 10"

KEVORKIAN
 27-574-23
 27-574-25

24 cm. 9 1/2"

27-576-01 27-576-02

Suitable for colposcopy, with steady cut
 für Kolposkopie geeignet, mit ziehendem Schnitt
 apropiado para colposcopia, con corte constante
 convient en colposcopie, avec coupe constante
 impiegata per colposcopia, a taglio fisso

SCHUMACHER
 27-576-01
 27-576-02

18,5 cm, 7 1/4"

27-580-01 27-580-02

Jaws straight
 Maul gerade
 boca rectas
 mors droits
 morso retto

Jaws curved to left, with steady cut
 Maul nach links gebogen, mit ziehendem Schnitt
 boca curva hacia la izquierda, con corte constante
 Mors courbes à gauche, avec coupe constante
 morsi curvi a sinistra, a taglio fisso

WITTNER
 27-580-01
 27-580-02

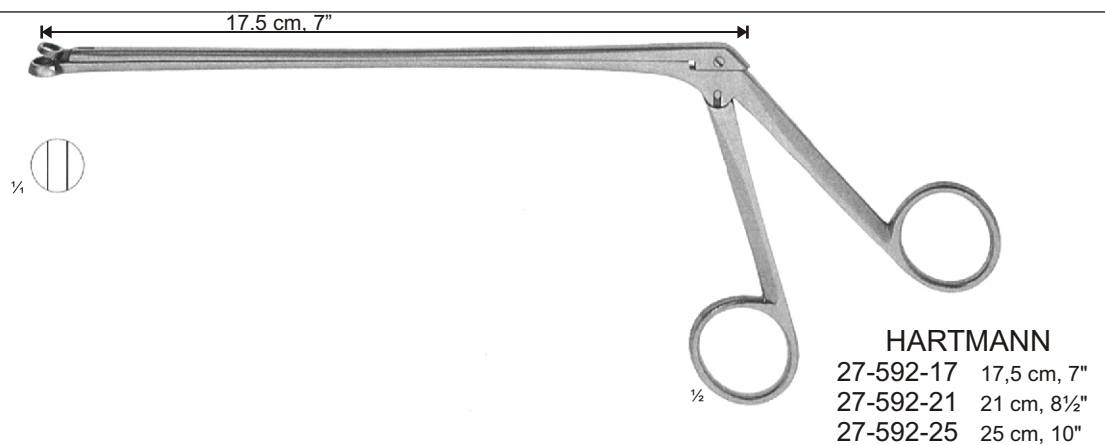
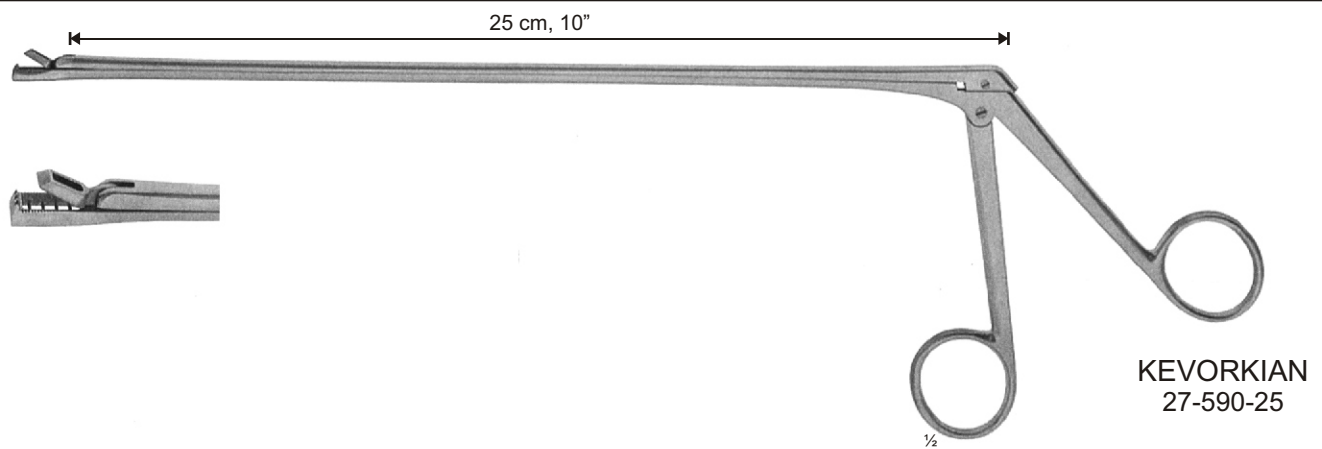
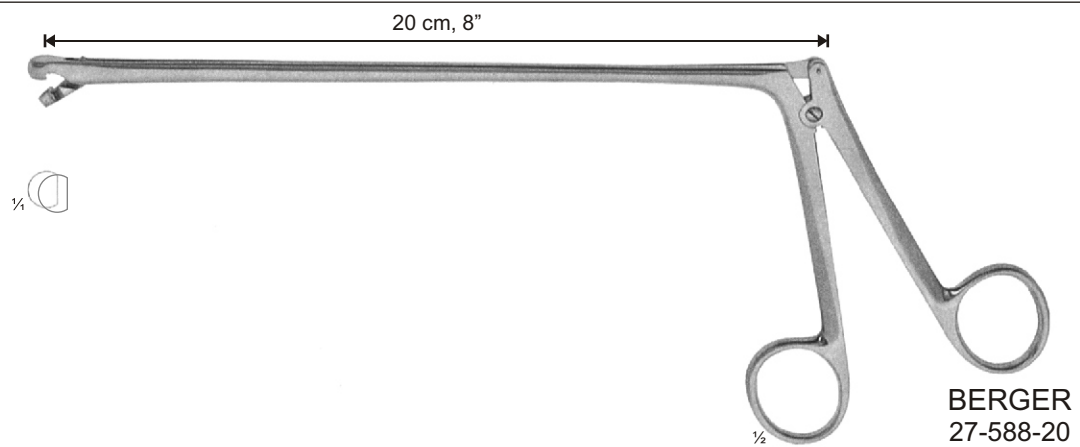
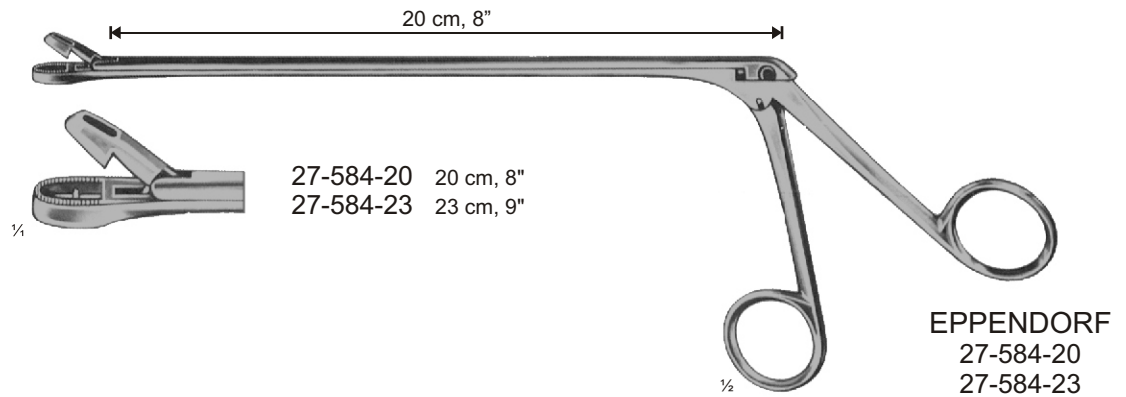

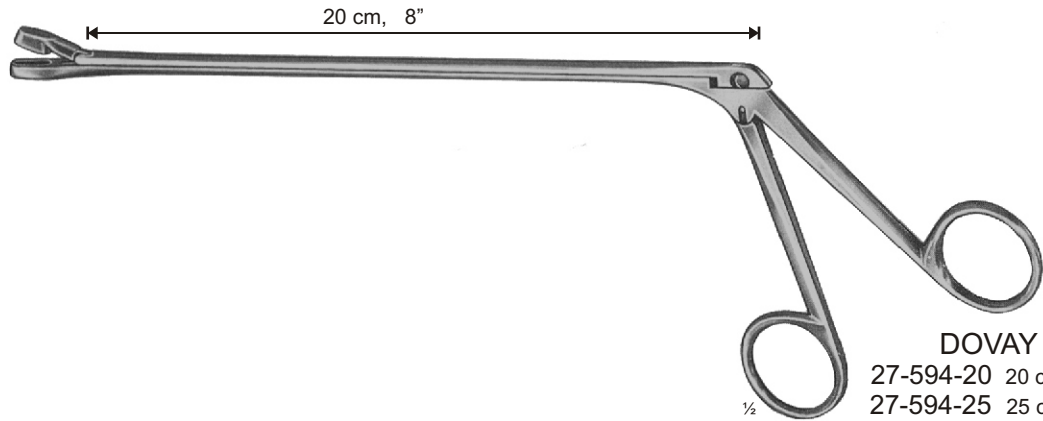

DOVAY

- 27-594-20 20 cm, 8"
- 27-594-25 25 cm, 10"
- 27-594-30 30 cm, 12"
- 27-594-35 35 cm, 14"
- 27-594-40 40 cm, 16"

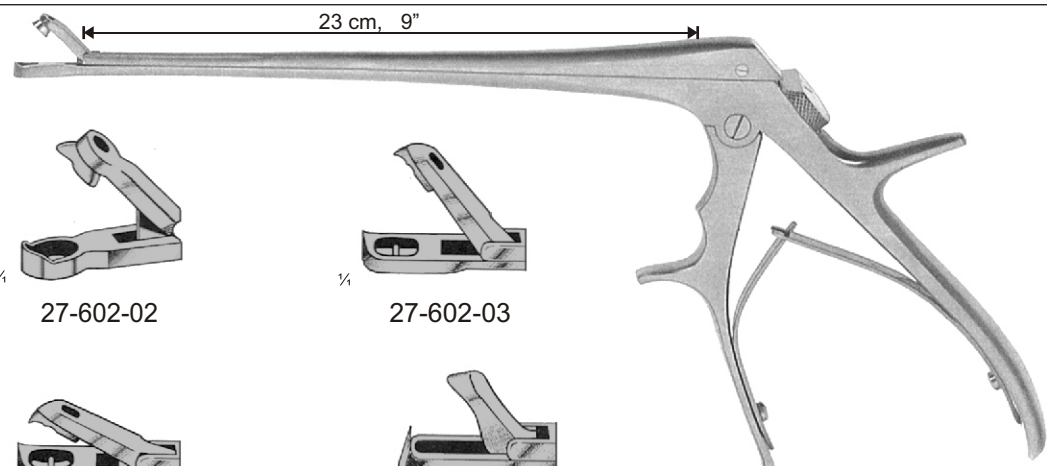

BURKE

- 27-602-01
- 27-602-05
- 23 cm, 9"



27-602-01

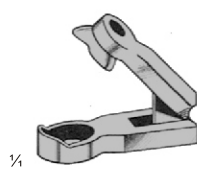

27-602-02

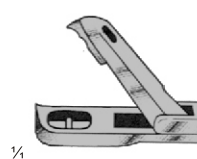

27-602-03

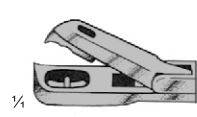

27-602-04



27-602-05

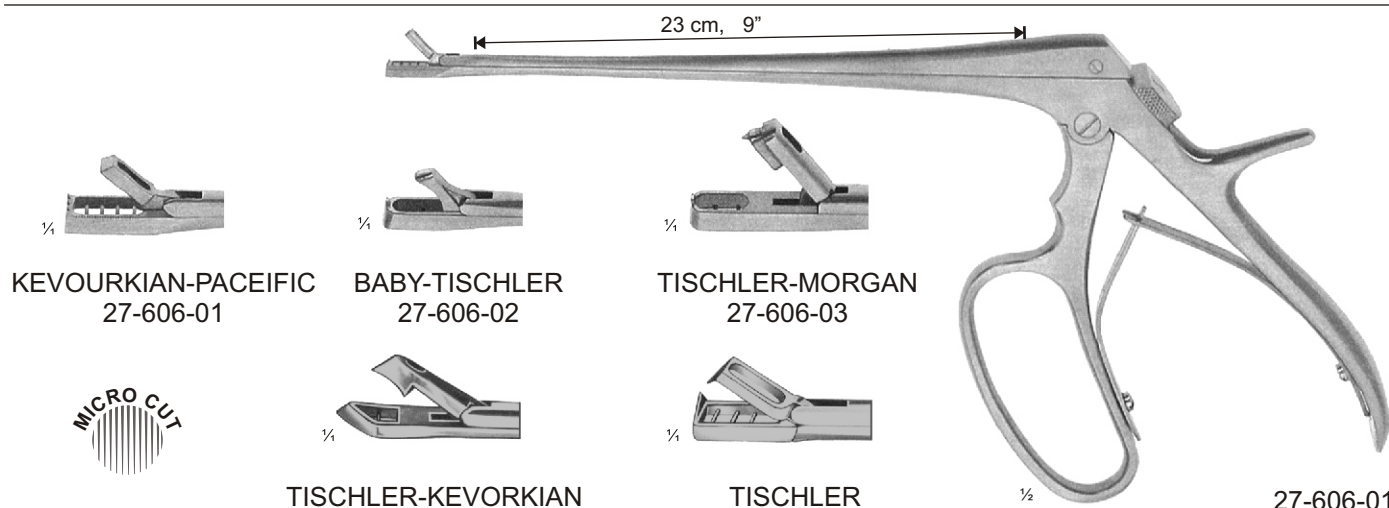

- 27-606-01
- 27-606-05
- 23 cm, 9"

KEVOURKIAN-PACEIFIC
27-606-01

BABY-TISCHLER
27-606-02

TISCHLER-MORGAN
27-606-03



TISCHLER-KEVORKIAN
27-606-04



TISCHLER
27-606-05



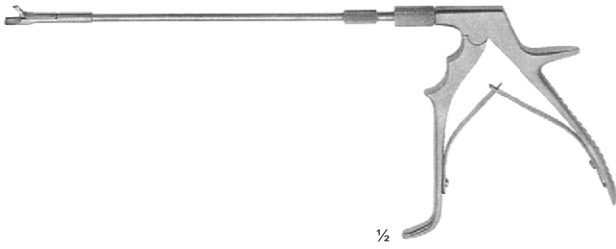

½









½

Complete instrument
 Instrument komplett
 Instrumento completo
 Instrument complet
 Strumento completo

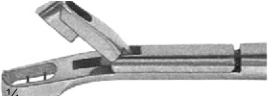
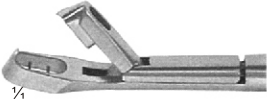
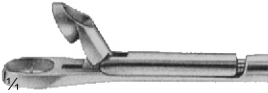
Complete instrument
 Instrument komplett
 Instrumento completo
 Instrument complet
 Strumento completo

Tip with tube
 Aufsatz mit Rohr
 Punta con tubo
 Tige avec embout
 Punta con asta

Handle
 Griff
 Mango
 Manche
 Manico

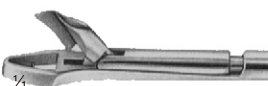
<p>Straight Gerade Recta Droit Retta</p>	 <p>TOWNSEND 27-610-01</p>	 <p>TISCHLER 27-610-02</p>	<p>Angled downward Abwärts gewinkelt Angulada hacia abajo Angulé en dessous angolata inferiormente</p>	<p>27-610-23</p>	<p>27-610-30</p>
<p>Angled upward Aufwärts gewinkelt Angulada hacia arriba Angulé au dessus angolata superiormente</p>	 <p>TISCHLER 27-610-07</p>	 <p>KEVOURKIAN YOUNGE 27-610-04</p>	<p>Straight Gerade Recta Droit Retta</p>	<p>27-610-23</p>	<p>27-610-30</p>
<p>Angled downward Abwärts gewinkelt Angulada hacia abajo Angulé en dessous angolata inferiormente</p>	 <p>TOWNSEND 27-610-05</p>	 <p>KRAUSE 27-610-06</p>	<p>Straight Gerade Recta Droit Retta</p>	<p>27-610-23</p>	<p>27-610-30</p>
<p>Straight Gerade Recta Droit Retta</p>	 <p>TOWNSEND 27-610-03</p>	 <p>SCHEINMANN 27-610-08</p>	<p>Angled downward Abwärts gewinkelt Angulada hacia abajo Angulé en dessous angolata inferiormente</p>	<p>27-610-23</p>	<p>27-610-30</p>
<p>Angled upward Aufwärts gewinkelt Angulada hacia arriba Angulé au dessus angolata superiormente</p>	 <p>TISCHLER 27-610-09</p>	 <p>SCHUMACHER 27-610-10</p>	<p>Straight Gerade Recta Droit Retta</p>	<p>27-610-23</p>	<p>27-610-30</p>

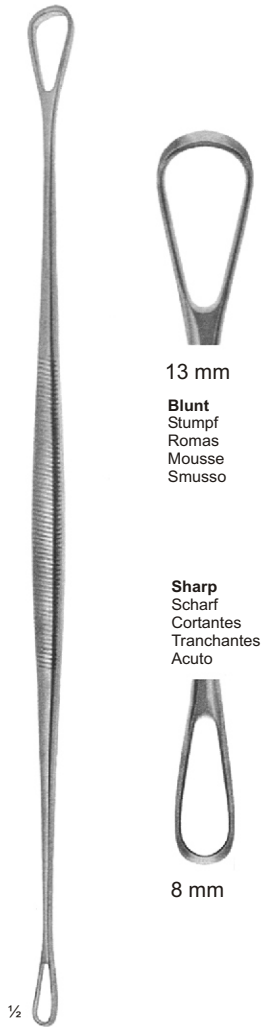

13 mm
Blunt
 Stumpf
 Romas
 Mousse
 Smusso

Sharp
 Scharf
 Cortantes
 Tranchantes
 Acuto

8 mm

BLAKE
 27-622-27
 27 cm, 10½"
 27-622-31
 31 cm, 12¼"

Uterine curette
 Uteruskürette
 Cureta uterina
 Curette utérine
 Curette uterine

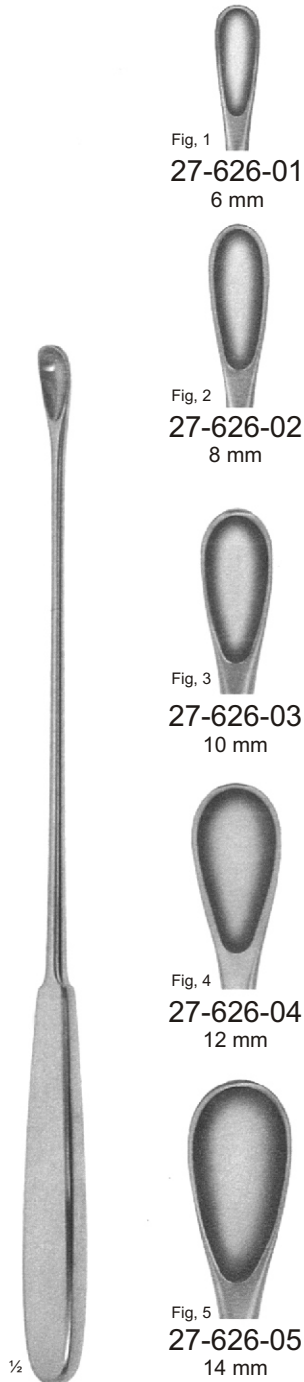

Fig. 1
 27-626-01
 6 mm

Fig. 2
 27-626-02
 8 mm

Fig. 3
 27-626-03
 10 mm

Fig. 4
 27-626-04
 12 mm

Fig. 5
 27-626-05
 14 mm

GOURDET
 27-626-01
 27-626-05
 28 cm, 11"

Uterine scoops, blunt / rigid
 Uteruslöffel, stumpf / fest
 Cucharillas uterinas, romas / rígidas
 Curéttés utérines, mousses / rigides
 Curette uterine, smusse / rigide

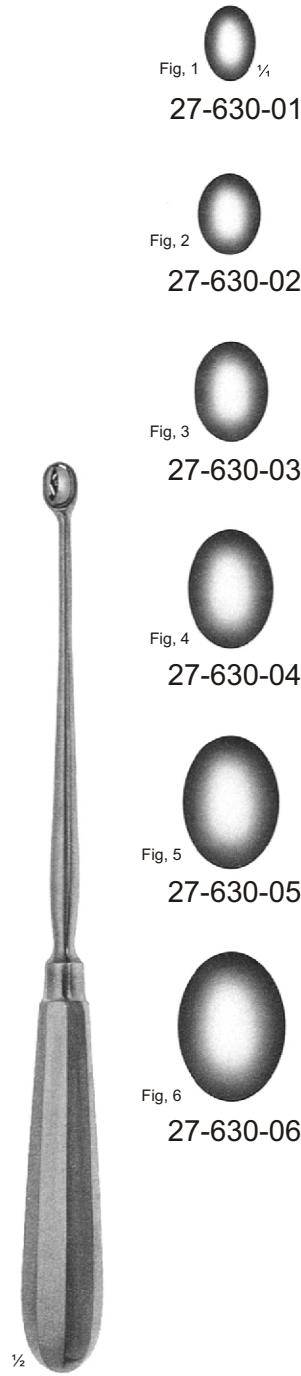

Fig. 1
 27-630-01

Fig. 2
 27-630-02

Fig. 3
 27-630-03

Fig. 4
 27-630-04

Fig. 5
 27-630-05

Fig. 6
 27-630-06

SIMON
 27-630-01
 27-630-06
 25 cm, 10"

Uterine scoops, sharp / rigid
 Uteruslöffel, scharf / fest
 Cucharillas uterinas, cortante / rígidas
 Curéttés utérines, tranchantes / rigides
 Curette uterine, acute / rigide

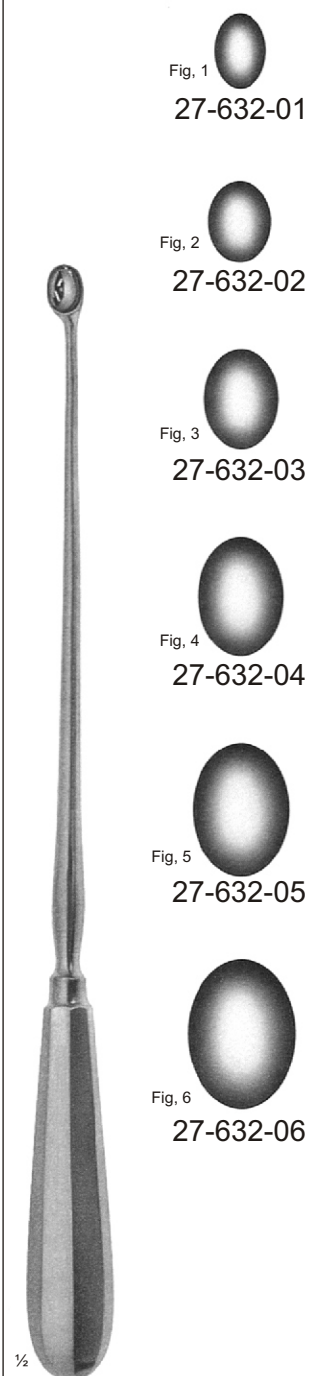

Fig. 1
 27-632-01

Fig. 2
 27-632-02

Fig. 3
 27-632-03

Fig. 4
 27-632-04

Fig. 5
 27-632-05

Fig. 6
 27-632-06

SCHRODER
 27-632-01
 27-632-06
 30 cm, 12"

Uterine scoops, sharp / rigid
 Uteruslöffel, scharf / fest
 Cucharillas uterinas, cortante / rígidas
 Curéttés utérines, tranchantes / rigides
 Curette uterine, acute / rigide



- 27-640-05 fig 00
- 27-640-06 fig 0
- 27-640-07 fig 01
- 27-640-08 fig 02
- 27-640-09 fig 03
- 27-640-11 fig 04
- 27-640-12 fig 05
- 27-640-14 fig 06
- 27-640-15 fig 07
- 27-640-16 fig 08
- 27-640-19 fig 09
- 27-640-20 fig 10
- 27-640-21 fig 11
- 27-640-23 fig 12
- 27-640-25 fig 13
- 27-640-30 fig 14
- 27-640-35 fig 15
- 27-640-40 fig 16

½

RECAMIER
 27-640-05
 27-641-40
 31 cm, 12½"

Blunt, rigid
 Stumpf, fest
 Romas, rígidas
 Mousse, rigides
 Smusse, rigide

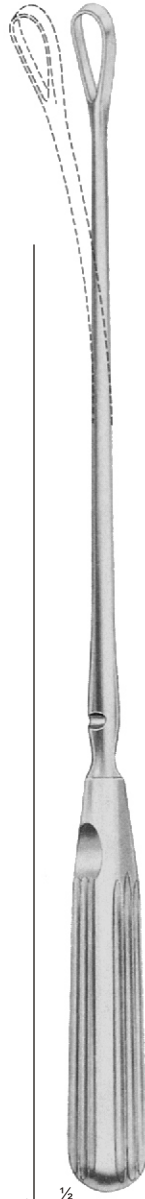

- 27-641-05 fig 00
- 27-641-06 fig 0
- 27-641-07 fig 01
- 27-641-08 fig 02
- 27-641-09 fig 03
- 27-641-11 fig 04
- 27-641-12 fig 05
- 27-641-14 fig 06
- 27-641-15 fig 07
- 27-641-16 fig 08
- 27-641-19 fig 09
- 27-641-20 fig 10
- 27-641-21 fig 11
- 27-641-23 fig 12
- 27-641-25 fig 13
- 27-641-30 fig 14
- 27-641-35 fig 15
- 27-641-40 fig 16

½

RECAMIER
 27-641-05
 27-641-40
 31 cm, 12½"

sharp, malleable
 scharf, biegsam
 cortantes, maleables
 tranchantes, malléables
 acute, malleabile



- 27-644-05 fig 00
- 27-644-06 fig 0
- 27-644-07 fig 01
- 27-644-08 fig 02
- 27-644-09 fig 03
- 27-644-11 fig 04
- 27-644-12 fig 05
- 27-644-14 fig 06
- 27-644-15 fig 07
- 27-644-16 fig 08
- 27-644-19 fig 09
- 27-644-20 fig 10
- 27-644-21 fig 11
- 27-644-23 fig 12
- 27-644-25 fig 13
- 27-644-30 fig 14
- 27-644-35 fig 15
- 27-644-40 fig 16

½

RECAMIER
 27-644-05
 27-644-40
 31 cm, 12½"

Blunt, rigid
 Stumpf, fest
 Romas, rígidas
 Mousse, rigides
 Smusse, rigide

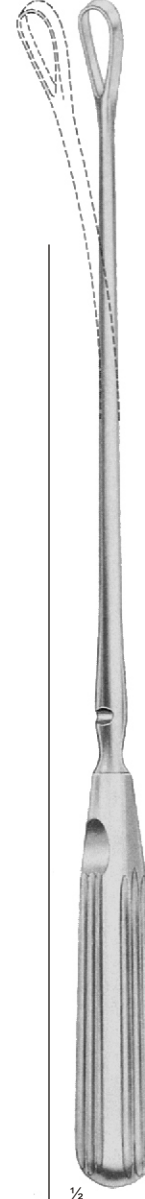

- 27-645-05 fig 00
- 27-645-06 fig 0
- 27-645-07 fig 01
- 27-645-08 fig 02
- 27-645-09 fig 03
- 27-645-11 fig 04
- 27-645-12 fig 05
- 27-645-14 fig 06
- 27-645-15 fig 07
- 27-645-16 fig 08
- 27-645-19 fig 09
- 27-645-20 fig 10
- 27-645-21 fig 11
- 27-645-23 fig 12
- 27-645-25 fig 13
- 27-640-30 fig 14
- 27-640-35 fig 15
- 27-640-40 fig 16

½

RECAMIER
 27-645-05
 27-645-40
 31 cm, 12½"

sharp, malleable
 scharf, biegsam
 cortantes, maleables
 tranchantes, malléables
 acute, malleabile



½

- 27-650-05 fig 00
- 27-650-06 fig 0
- 27-650-07 fig 01
- 27-650-08 fig 02
- 27-650-09 fig 03
- 27-650-11 fig 04
- 27-650-12 fig 05
- 27-650-14 fig 06
- 27-650-15 fig 07
- 27-650-16 fig 08
- 27-650-19 fig 09
- 27-650-20 fig 10
- 27-650-21 fig 11
- 27-650-23 fig 12
- 27-650-25 fig 13
- 27-650-30 fig 14
- 27-650-35 fig 15
- 27-650-40 fig 16

SIMS
 27-650-05
 27-650-40
 31 cm, 12½"

Blunt, rigid
 Stumplt, fest
 Romas, rígidas
 Moussees, rigides
 Smusse, rigide

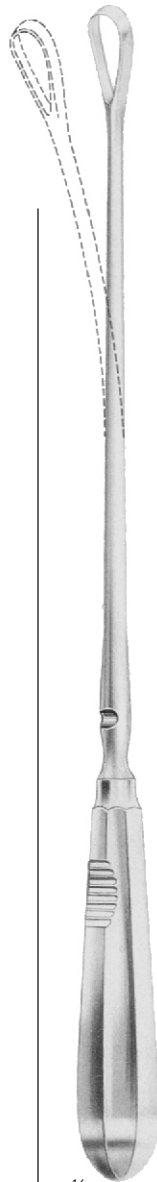

½

- 27-651-05 fig 00
- 27-651-06 fig 0
- 27-651-07 fig 01
- 27-651-08 fig 02
- 27-651-09 fig 03
- 27-651-11 fig 04
- 27-651-12 fig 05
- 27-651-14 fig 06
- 27-651-15 fig 07
- 27-651-16 fig 08
- 27-651-19 fig 09
- 27-651-20 fig 10
- 27-651-21 fig 11
- 27-651-23 fig 12
- 27-651-25 fig 13
- 27-651-30 fig 14
- 27-651-35 fig 15
- 27-651-40 fig 16

SIMS
 27-651-05
 27-651-40
 31 cm, 12½"

sharp, malleable
 scharf, biegsam
 cortantes, maleables
 tranchantes, malléables
 acute, malleabile

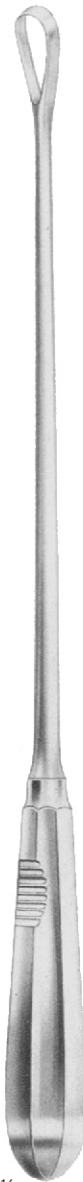

½

- 27-654-05 fig 00
- 27-654-06 fig 0
- 27-654-07 fig 01
- 27-654-08 fig 02
- 27-654-09 fig 03
- 27-654-11 fig 04
- 27-654-12 fig 05
- 27-654-14 fig 06
- 27-654-15 fig 07
- 27-654-16 fig 08
- 27-654-19 fig 09
- 27-654-20 fig 10
- 27-654-21 fig 11
- 27-654-23 fig 12
- 27-654-25 fig 13
- 27-654-30 fig 14
- 27-654-35 fig 15
- 27-654-40 fig 16

SIMS
 27-654-05
 27-654-40
 31 cm, 12½"

Blunt, rigid
 Stumplt, fest
 Romas, rígidas
 Moussees, rigides
 Smusse, rigide

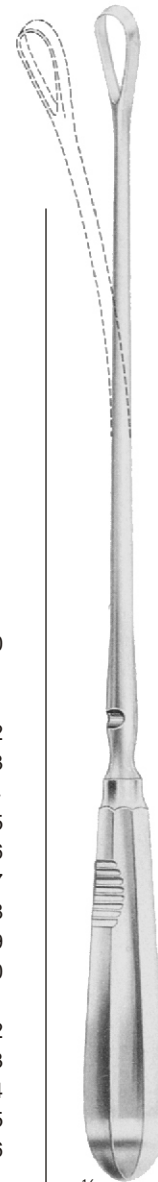

½

- 27-655-05 fig 00
- 27-655-06 fig 0
- 27-655-07 fig 01
- 27-655-08 fig 02
- 27-655-09 fig 03
- 27-655-11 fig 04
- 27-655-12 fig 05
- 27-655-14 fig 06
- 27-655-15 fig 07
- 27-655-16 fig 08
- 27-655-19 fig 09
- 27-655-20 fig 10
- 27-655-21 fig 11
- 27-655-23 fig 12
- 27-655-25 fig 13
- 27-655-30 fig 14
- 27-655-35 fig 15
- 27-655-40 fig 16

SIMS
 27-655-05
 27-655-40
 31 cm, 12½"

sharp, malleable
 scharf, biegsam
 cortantes, maleables
 tranchantes, malléables
 acute, malleabile

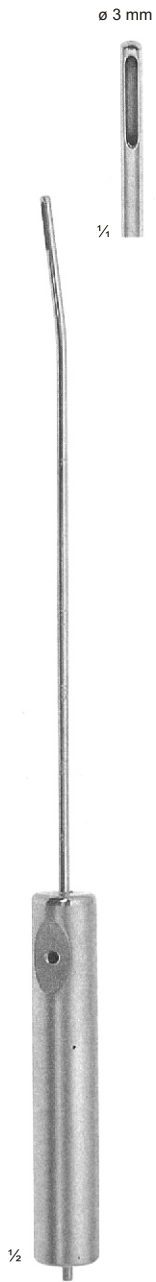

27-666-03
 28,5 cm, 11¼"



27-666-04
 28,5 cm, 11¼"

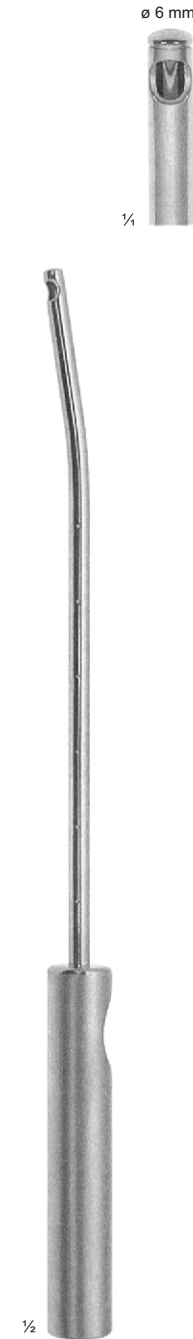

27-666-06
 28,5 cm, 11¼"



27-666-08
 28,5 cm, 11¼"

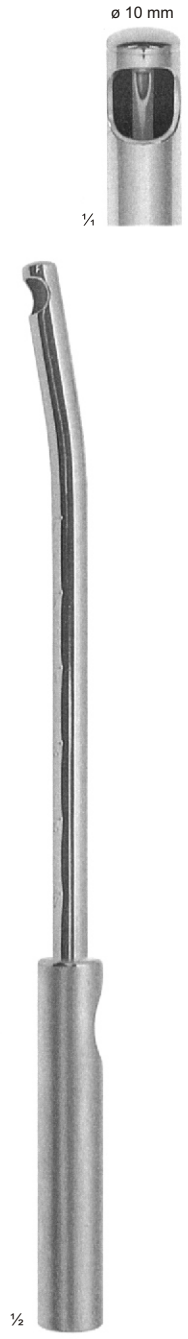

27-666-10
 28,5 cm, 11¼"

Specimen and aspirating curettes
 Probe-und absaugküretten
 Curetas de biopsia y de aspiracion
 Curettes à biopsie et d'aspiration
 Curette per prelieve ed aspirazione

Aspirating curettes
 Absaugküretten
 Curetas de aspiracion
 Curettes d'aspiration
 Curette per aspirazione



ø 12 mm



ø 14 mm

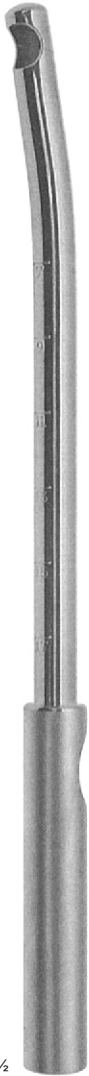

27-666-12
 28,5 cm, 11¼"

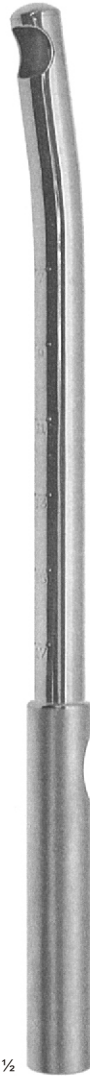

27-666-14
 28,5 cm, 11¼"

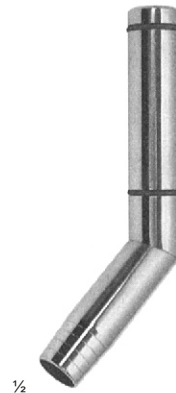

27-680-00

Coupling piece for the connection of aspirating currettes 27-666-03_27-666-14 to flexible tube having an interior diameter of 11 mm

Schlauchverbindungsstück für Absaugküretten 27-666-03 bis 27-666-14, für Saugschlauch von 11 mm Innen-e

Adaptador de tubo para curetas de aspiración 27-666-03-27-666-14 para tubos de aspiración. Ø interior de 11 mm

Embout adaptable aux curettes 27-666-03_27-666-14 pour tube d'aspiration, ø inférieur à 11 mm

Adattatore per la connessione delle curette per aspirazione 27-666-03_27-666-14 ad un tubo flessibile avente un ø int. di 11 mm



Fig. 1
 27-690-01
 10mm



Fig. 2
 27-690-02
 12mm



Fig. 3
 27-690-03
 14mm



GREENE
 27-690-01
 27-690-02
 28 cm, 11½"