

031

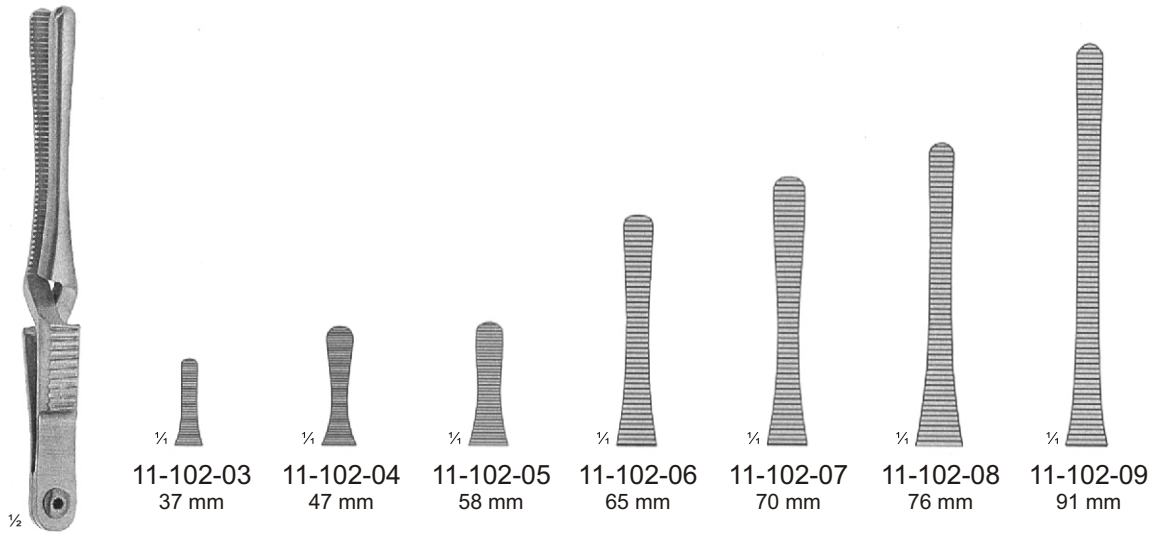

Cardiovascular Surgery
Herz-u. Gefäßchirurgie
Cirurgía cardiovascular
Chirurgie cardio-vasculaire
Chirurgia cardiovascolare



**JOHNS
 HOPKINS**
 11-102-03
 11-103-09

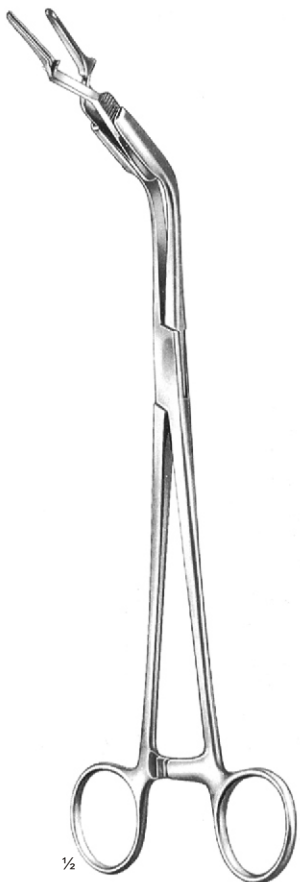

11-100-23
 23 cm, 9"

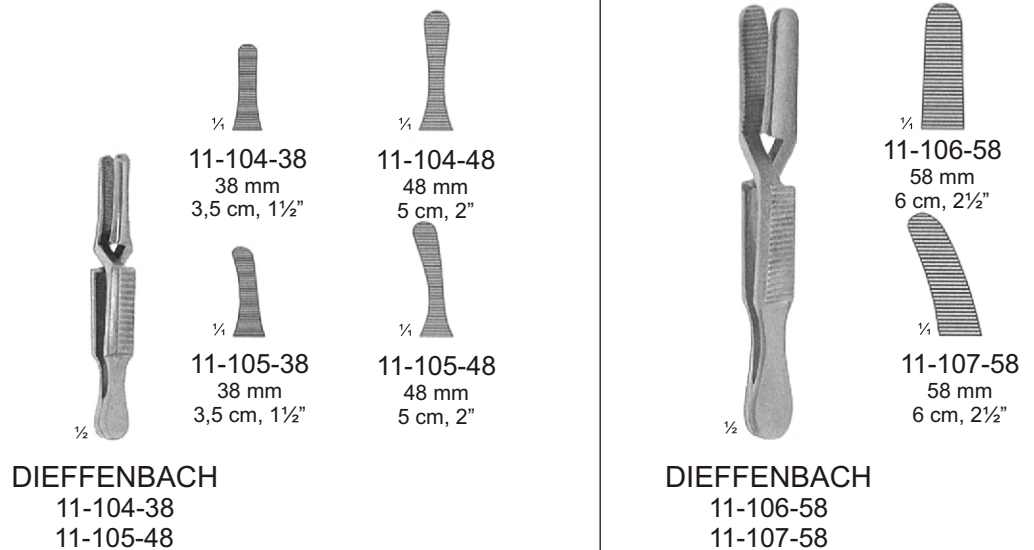
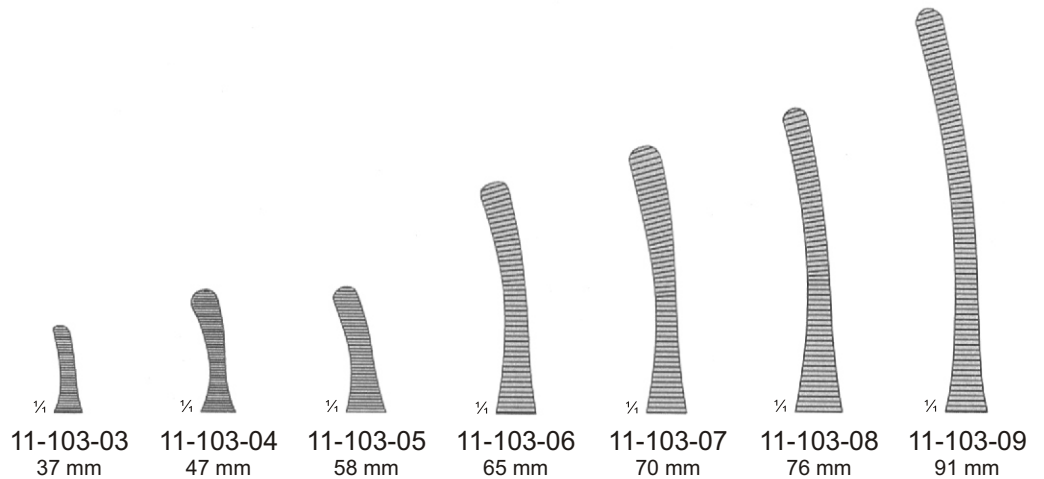

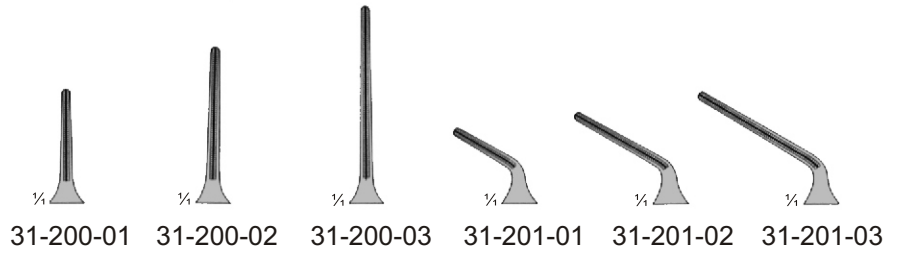

DIETHRICH
 31-200-01
 31-201-03

Length Länge Longitud Longeur Lungh	50 mm	50 mm	60 mm	50 mm	50 mm	60 mm
Length of jaw Maullänge Longitud de boca Longueur des mors Lungh dei morsi	10 mm	14 mm	20 mm	14 mm	14 mm	20 mm
Occlusion pressure Schließdruck Presión de oclusión Pression d'occlusion Pessione occlusiva	3 gr	3 gr	3 gr	3 gr	3 gr	3 gr
Weight Gewicht Peso Poids Peso	180 gr	180 gr	180 gr	180 gr	180 gr	180 gr



DIETHRICH
 31-210-01
 31-211-03

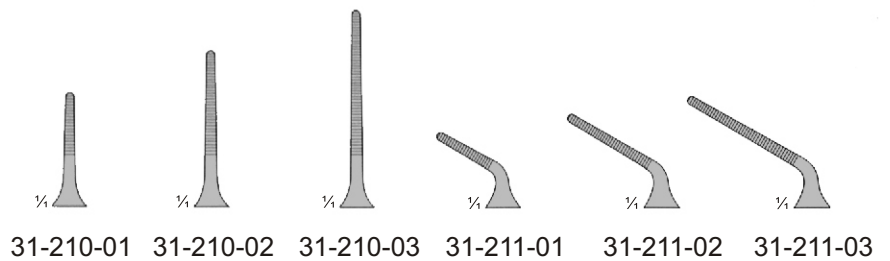

Length Länge Longitud Longeur Lungh	50 mm	50 mm	60 mm	50 mm	50 mm	60 mm
Length of jaw Maullänge Longitud de boca Longueur des mors Lungh dei morsi	8 mm	12 mm	20 mm	8 mm	12 mm	20 mm
Occlusion pressure Schließdruck Presión de oclusión Pression d'occlusion Pessione occlusiva	3 gr	3 gr	3 gr	3 gr	3 gr	3 gr
Weight Gewicht Peso Poids Peso	50 gr	50 gr	50 gr	50 gr	50 gr	50 gr

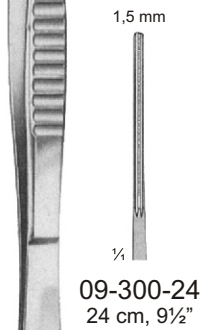
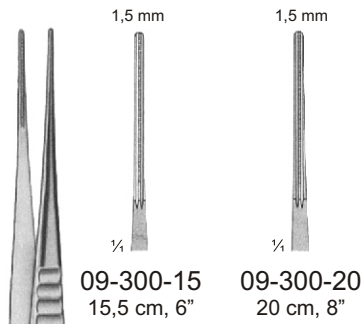
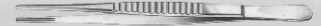

½ **De Bakey**

09-300-15
 09-300-24

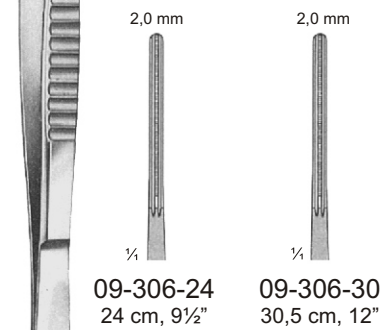
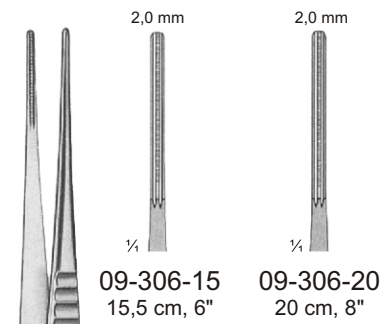

½ **De Bakey**

09-306-15
 09-306-30

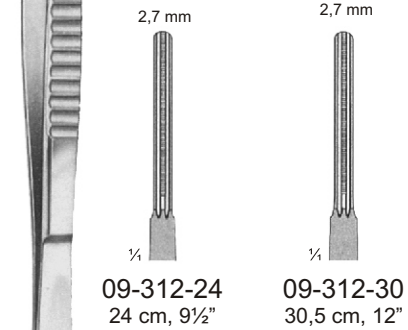
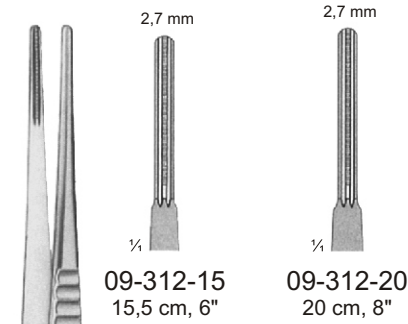

½ **De Bakey**

09-312-15
 09-312-30

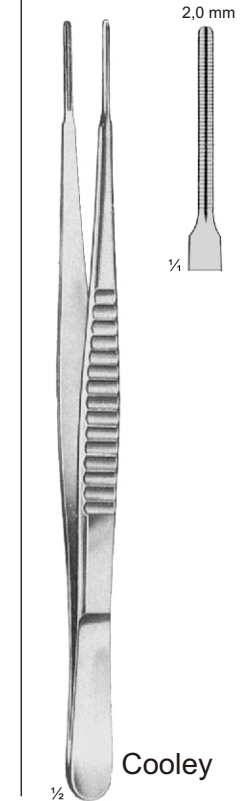

½ **Cooley**

09-316-16 16 cm, 6¼"
 09-316-20 20 cm, 8"

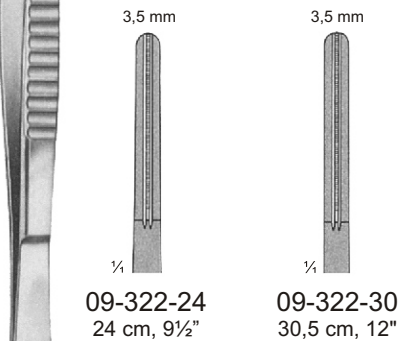
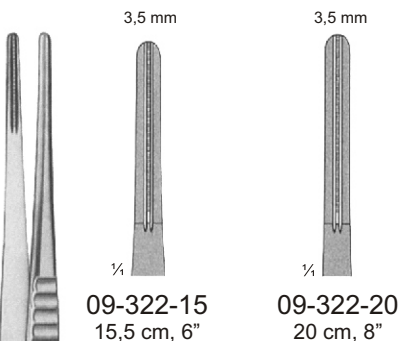

½ **De Bakey**

09-322-15
 09-322-30

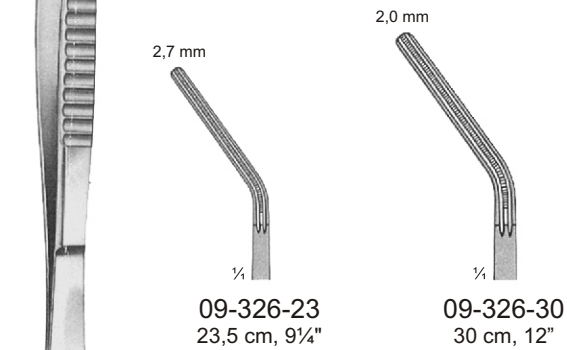
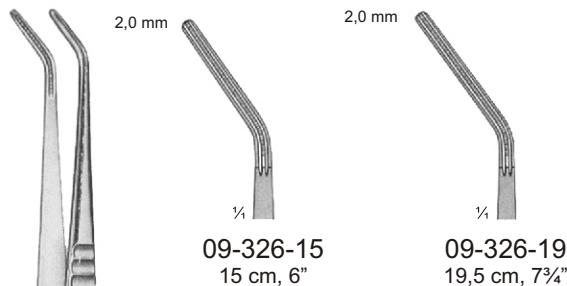

½ **De Bakey**

09-326-15
 09-326-30

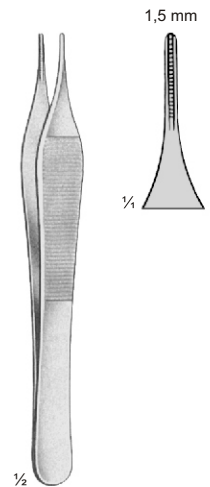

ADSON

09-330-12 12 cm, 4¾"
 09-330-15 15 cm, 6"

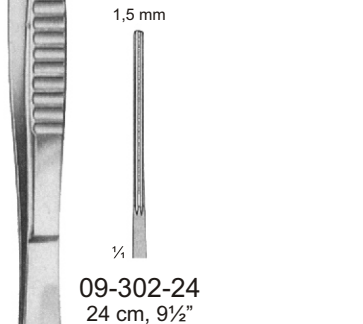
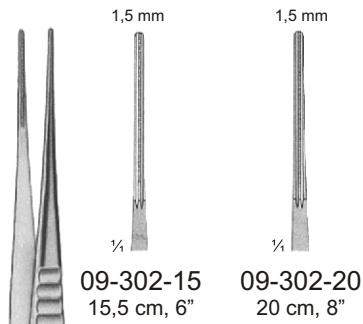
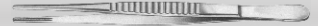

De Bakey

½

09-302-15
09-302-24 Titanium

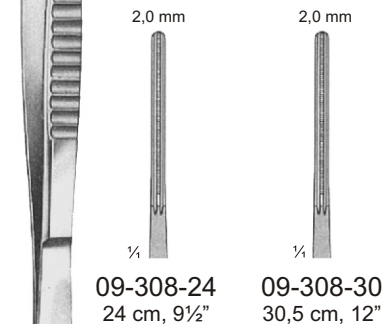
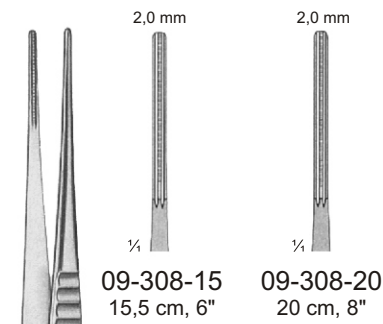

De Bakey

½

09-308-15
09-308-30 Titanium

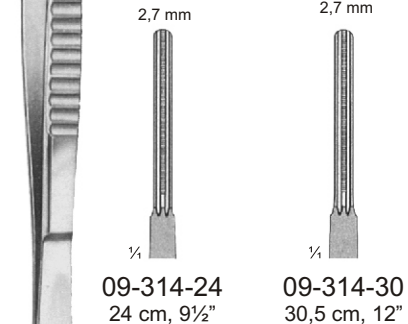
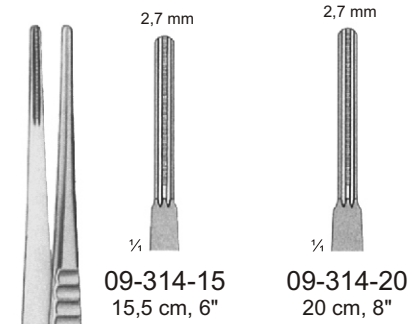

De Bakey

½

09-314-15
09-314-30 Titanium

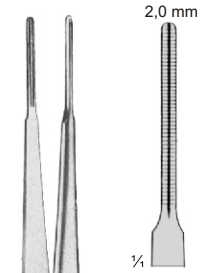

Cooley

½

Titanium

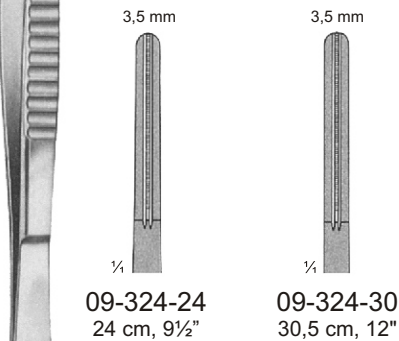
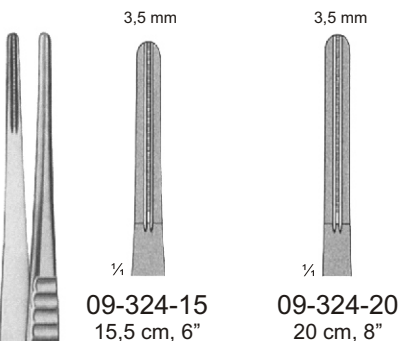

De Bakey

½

09-324-15
09-324-30 Titanium

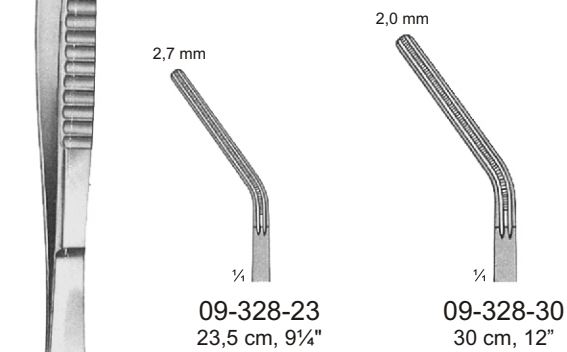
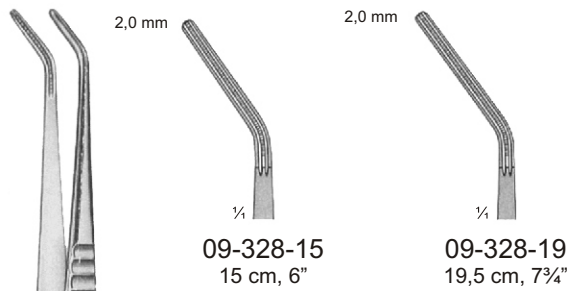

De Bakey

½

09-328-15
09-328-30 Titanium

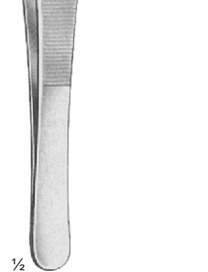
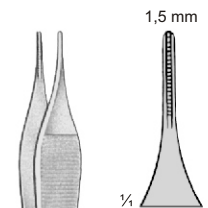

ADSON

½

Titanium

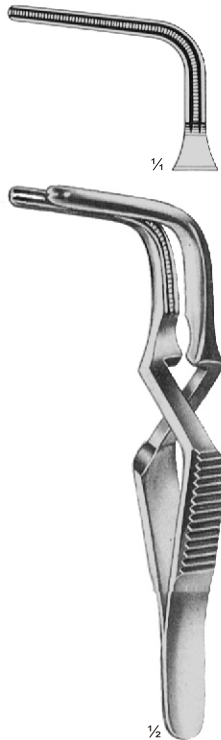
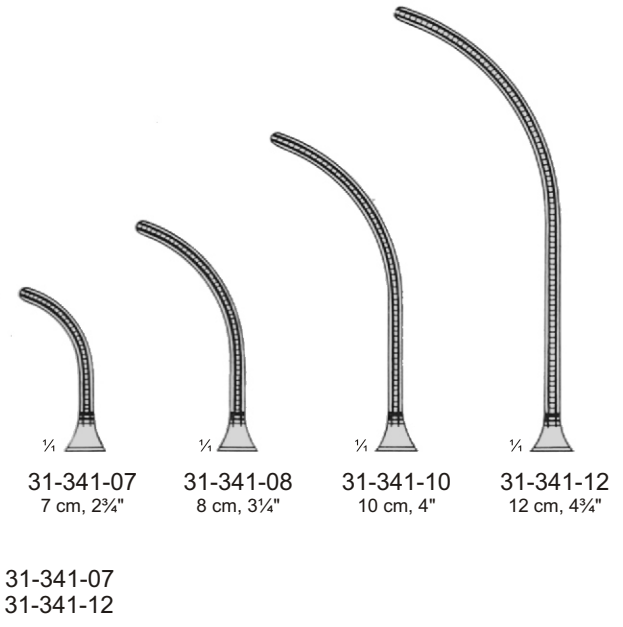
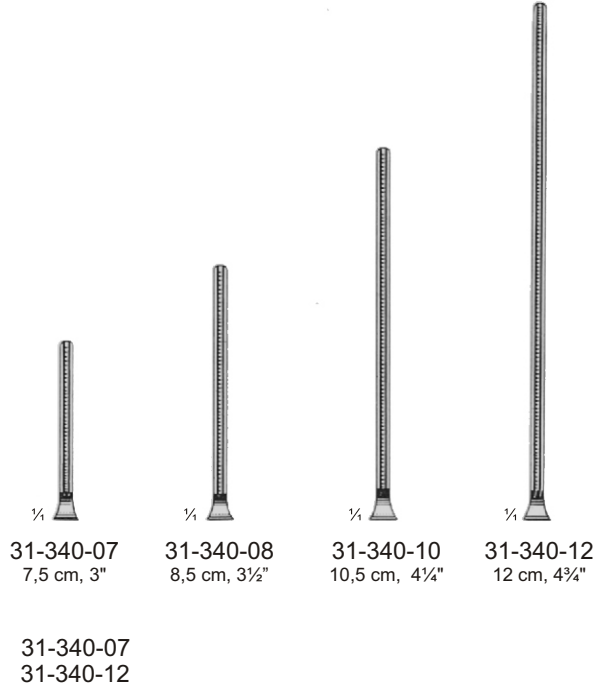

SANTULLI
31-351-07
7 cm, 2¾"

Carotid clamps
 Karotisklemmen
 Pinzas-clamps para carótis
 Pincés-clamps pour la carotide
 Pinze per la carotide

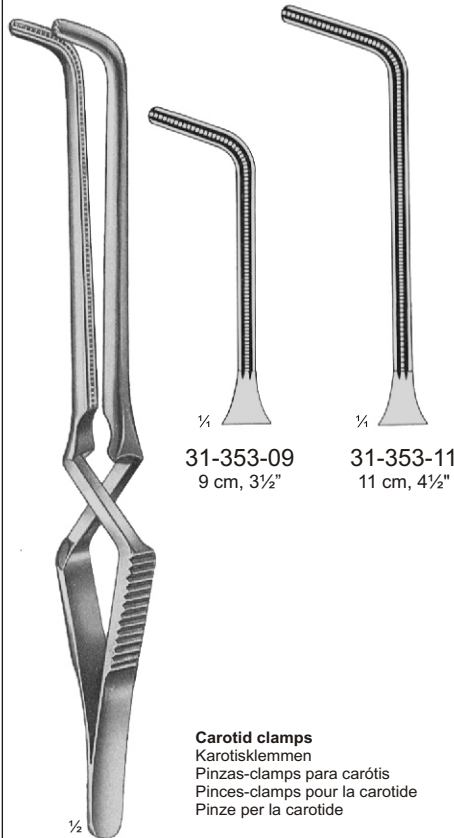

Carotid clamps
 Karotisklemmen
 Pinzas-clamps para carótis
 Pincés-clamps pour la carotide
 Pinze per la carotide

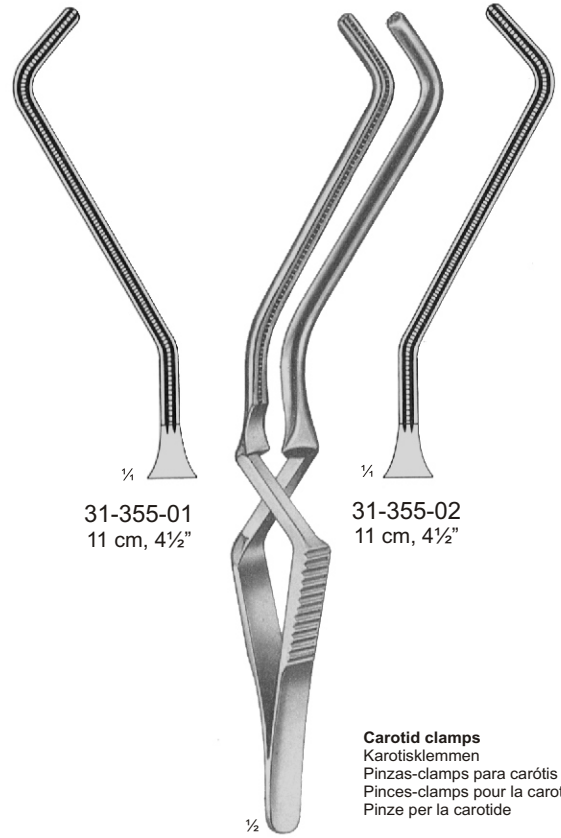

Carotid clamps
 Karotisklemmen
 Pinzas-clamps para carótis
 Pincés-clamps pour la carotide
 Pinze per la carotide



Occlusion pressure adjustable
 Schließdruck einstellbar
 Presion de oclución ajustable
 Pression d'occlusion ajustable
 Pressione occlusiva regolabile

1/2

31-360-06 6 cm, 2 1/2"
 31-360-07 7 cm, 2 3/4"
 31-360-09 9 cm, 3 1/2"
 31-360-11 11 cm, 4 1/2"

GLOVER
 31-360-06
 31-360-11

1/2

31-361-05 5,5 cm, 2 1/2"
 31-361-06 6,5 cm, 2 3/4"
 31-361-08 8,5 cm, 3 1/2"
 31-361-10 10,5 cm, 4 1/2"

GLOVER
 31-361-05
 31-361-10



GLOVER
 31-363-05
 5 cm, 2"



DE BAKEY-SATINSKY
 31-365-07
 7 cm, 2 3/4"

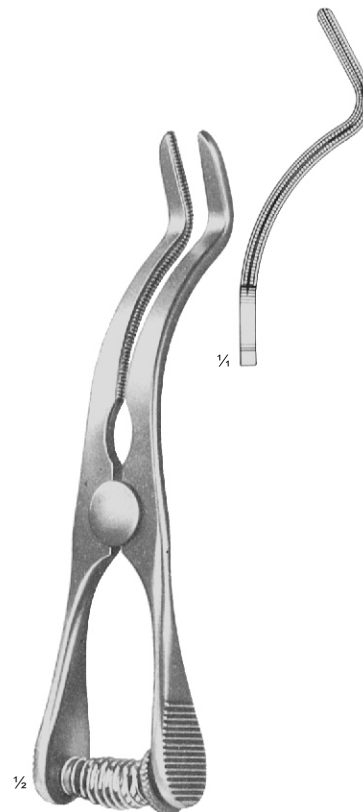

DE BAKEY-CAROTIS
 31-367-09
 9 cm, 3 1/2"

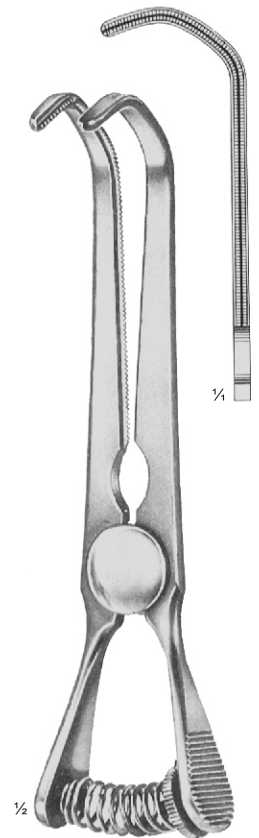

DE BAKEY-SATINSKY
 31-369-10
 10 cm, 4"

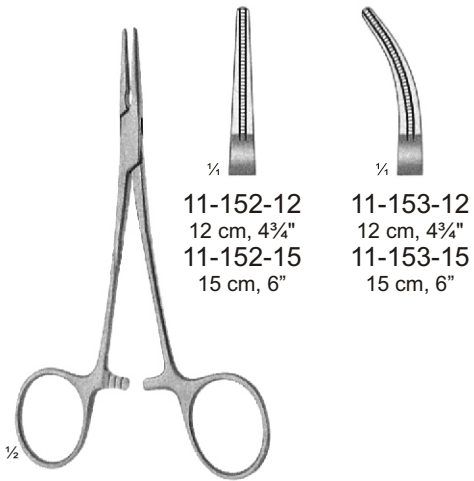
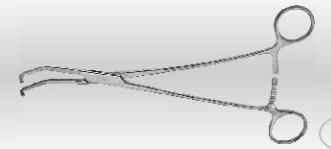

11-152-12
 12 cm, 4¾"
 11-152-15
 15 cm, 6"

11-153-12
 12 cm, 4¾"
 11-153-15
 15 cm, 6"

**DE BAKEY
 HALSTED-MOSQUITO**
 11-152-12
 11-153-15

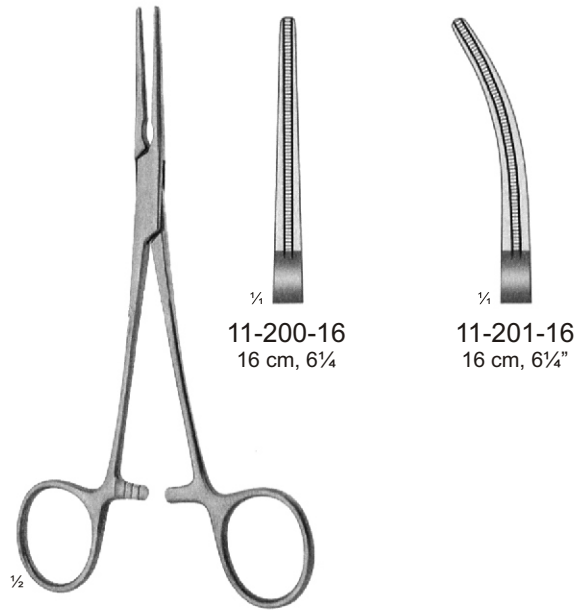

11-200-16
 16 cm, 6¼"

11-201-16
 16 cm, 6¼"

**DE BAKEY
 CRILE-RANKIN**
 11-200-16
 11-201-16

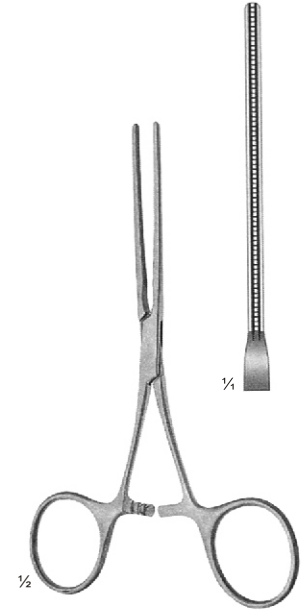

DE BAKEY
 31-370-12
 12cm, 4¾"

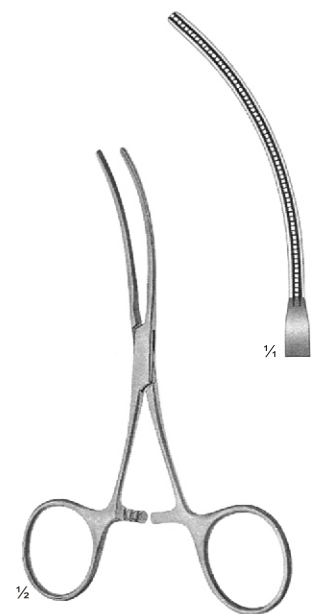

DE BAKEY
 31-371-12
 12 cm, 4¾"

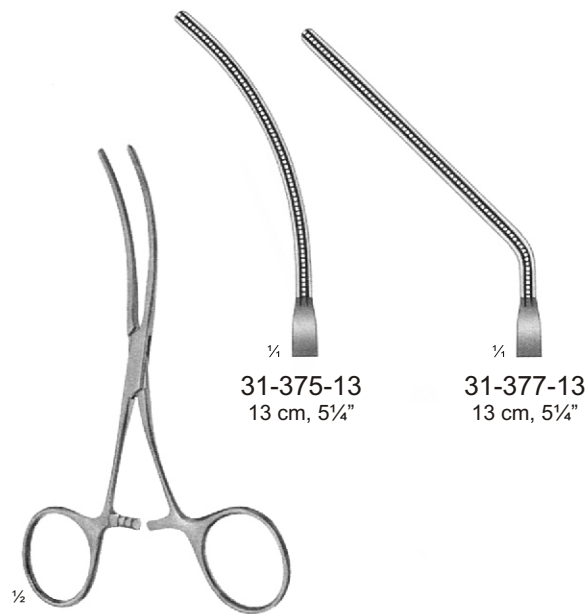

31-375-13
 13 cm, 5¼"

31-377-13
 13 cm, 5¼"

DE BAKEY
 31-375-13
 31-377-13



DE BAKEY
 31-381-10
 10 cm, 4"

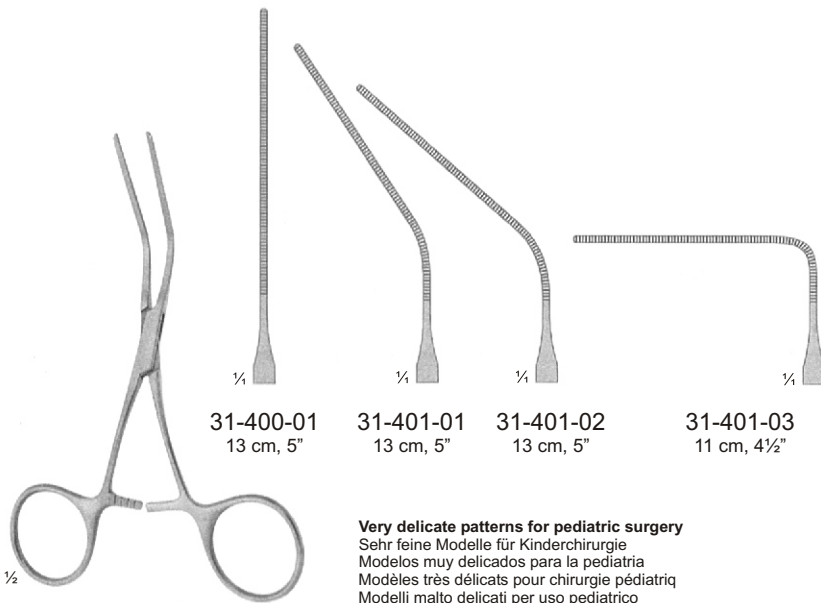
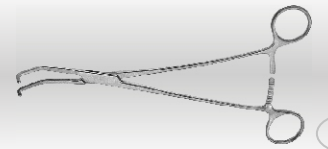

31-400-01
13 cm, 5"

31-401-01
13 cm, 5"

31-401-02
13 cm, 5"

31-401-03
11 cm, 4½"

Very delicate patterns for pediatric surgery
 Sehr feine Modelle für Kinderchirurgie
 Modelos muy delicados para la pediaatria
 Modèles très délicats pour chirurgie pédiatriq
 Modelli malto delicati per uso pediatrico

CASTANEDA
 31-400-01
 31-401-03

Multi-purpose clamps
 Mehrzweckklemmen
 Pinzas-clamps de varias aplicaciones
 Pincas-clamps universelles
 Pinze multiuso

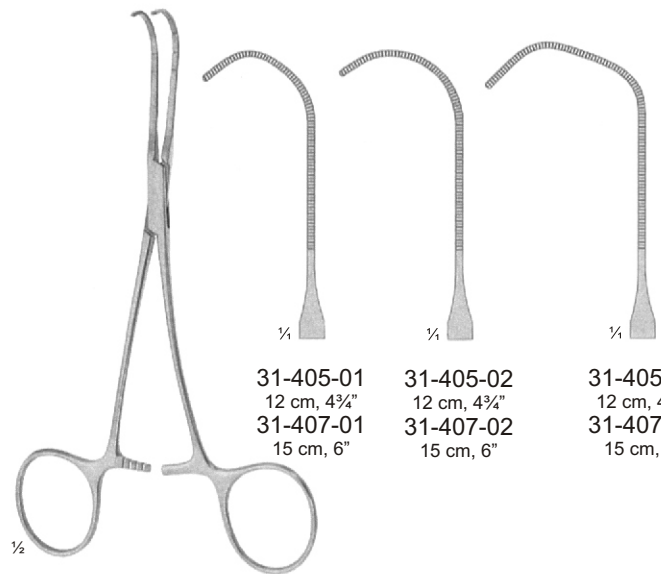

31-405-01
12 cm, 4¾"

31-405-02
12 cm, 4¾"

31-405-03
12 cm, 4¾"

31-407-01
15 cm, 6"

31-407-02
15 cm, 6"

31-407-03
15 cm, 6"

CASTANEDA
 31-405-01
 31-407-03

Very delicate patterns for pediatric surgery
 Sehr feine Modelle für Kinderchirurgie
 Modelos muy delicados para la pediaatria
 Modèles très délicats pour chirurgie pédiatriq
 Modelli malto delicati per uso pediatrico

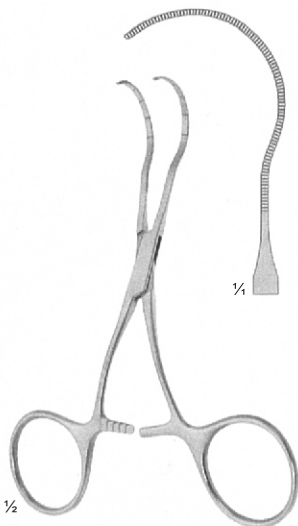

CASTANEDA
 31-409-12
 12 cm, 4¾"

Multi-purpose clamps
 Mehrzweckklemmen
 Pinzas-clamps de varias aplicaciones
 Pincas-clamps universelles
 Pinze multiuso

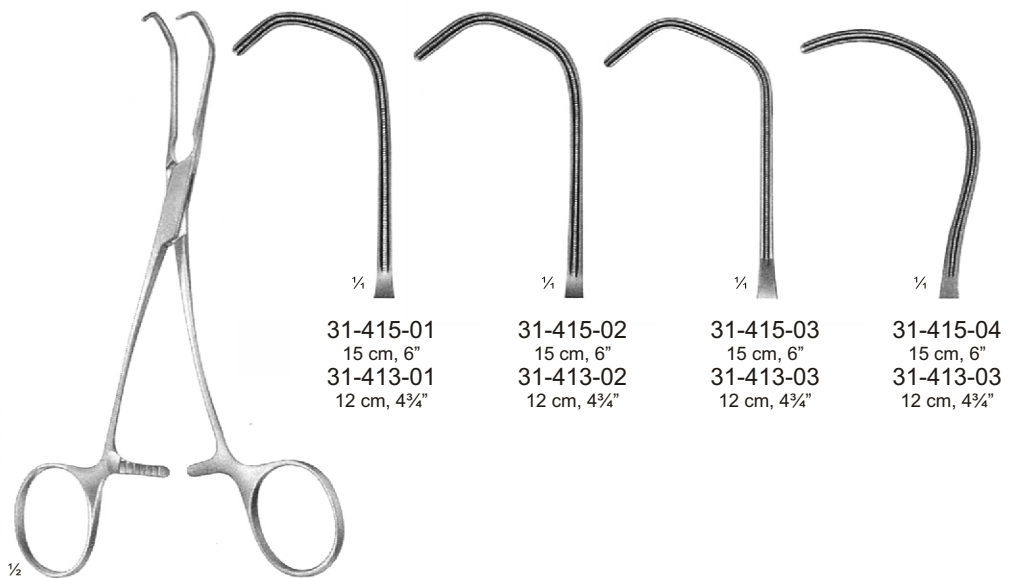

31-415-01
15 cm, 6"

31-415-02
15 cm, 6"

31-415-03
15 cm, 6"

31-415-04
15 cm, 6"

31-413-01
12 cm, 4¾"

31-413-02
12 cm, 4¾"

31-413-03
12 cm, 4¾"

31-413-03
12 cm, 4¾"

CASTANEDA
 31-413-01
 31-415-04

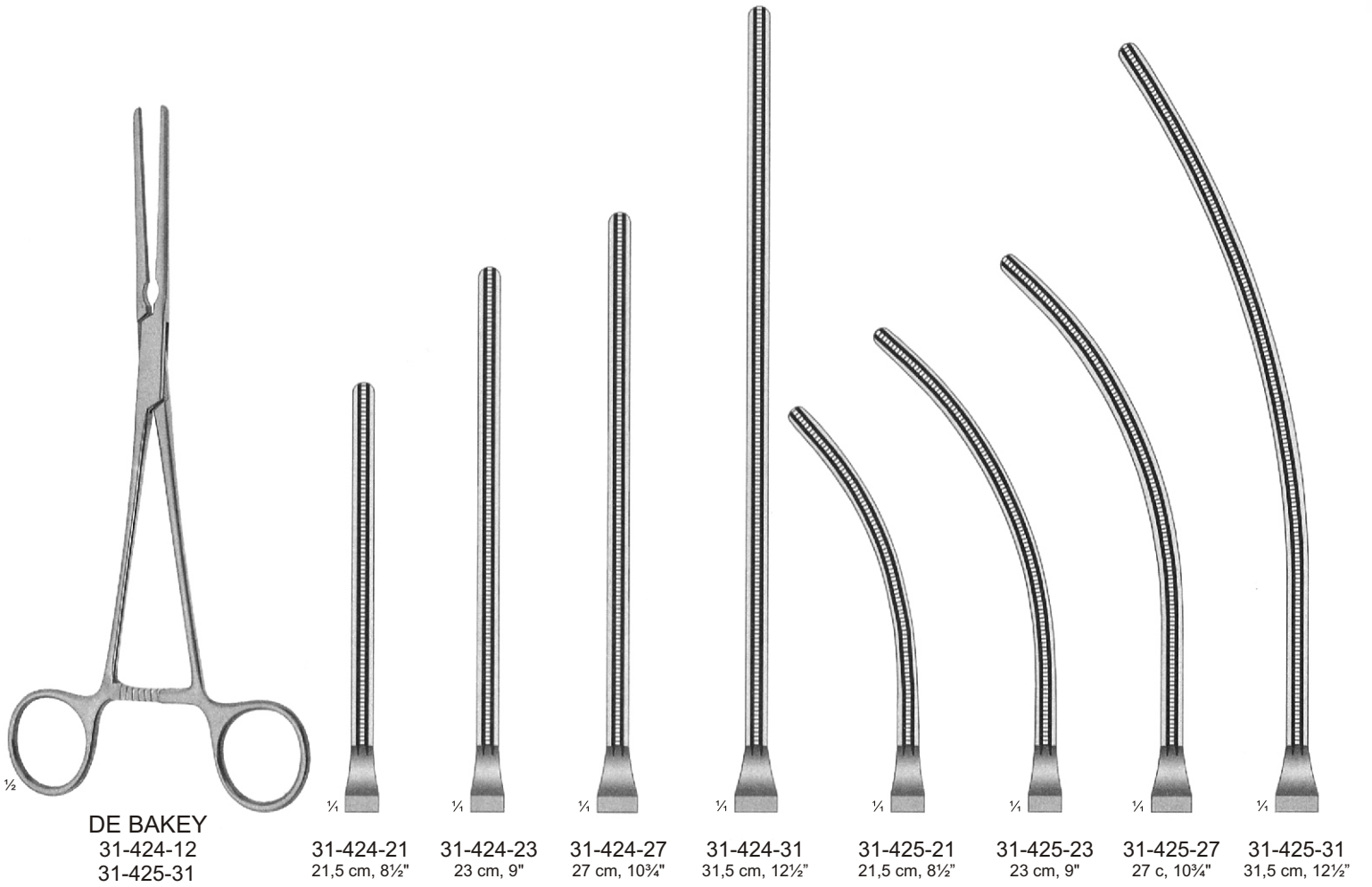
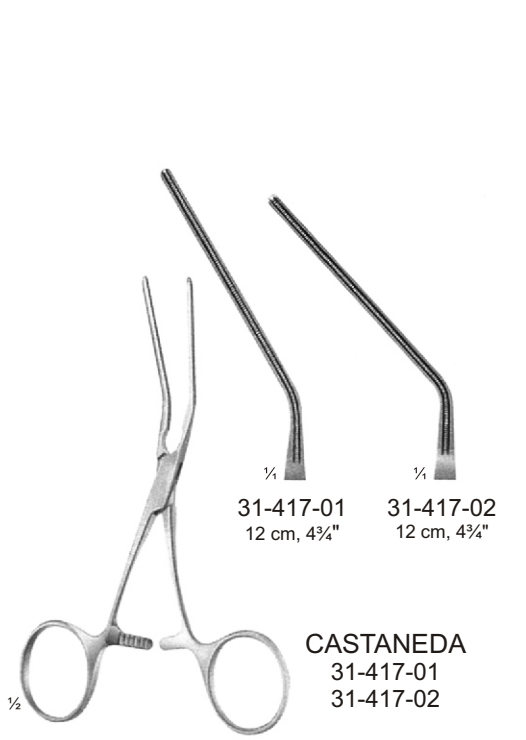
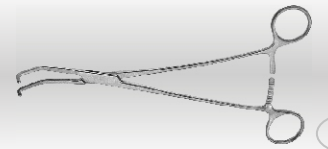

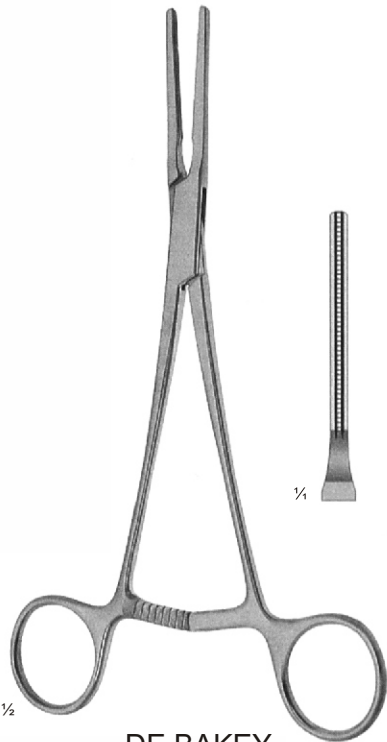
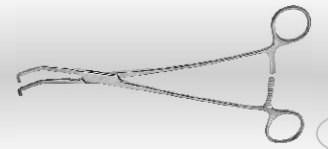

DE BAKEY
 31-430-15
 31-430-20

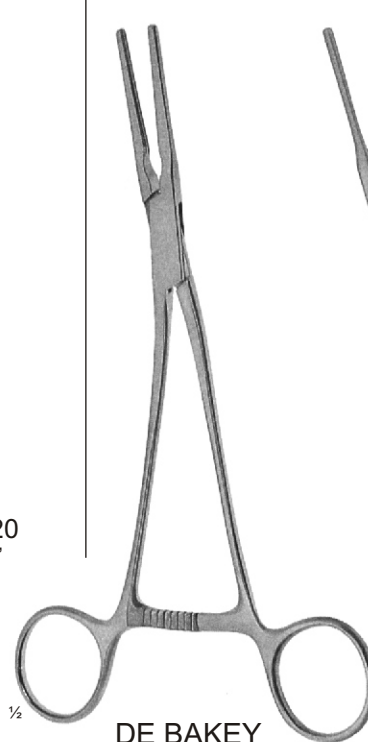

DE BAKEY
 31-431-15
 31-431-20

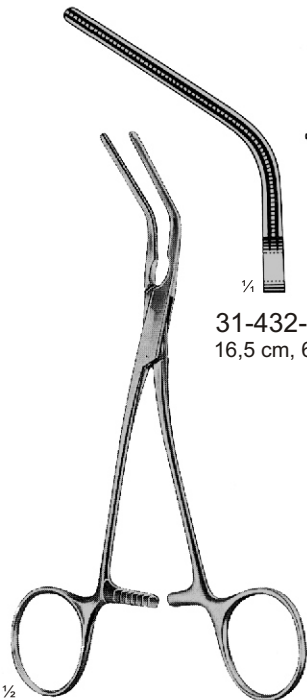

DE BAKEY
 31-432-16
 31-433-16

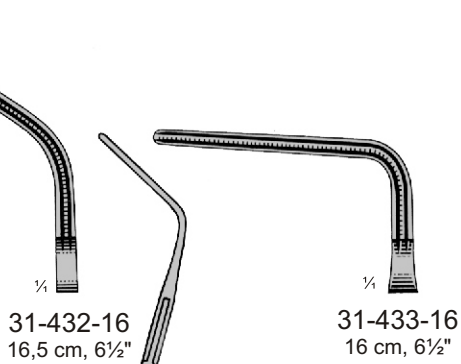

DE BAKEY-POTTS
 31-434-21
 31-435-21



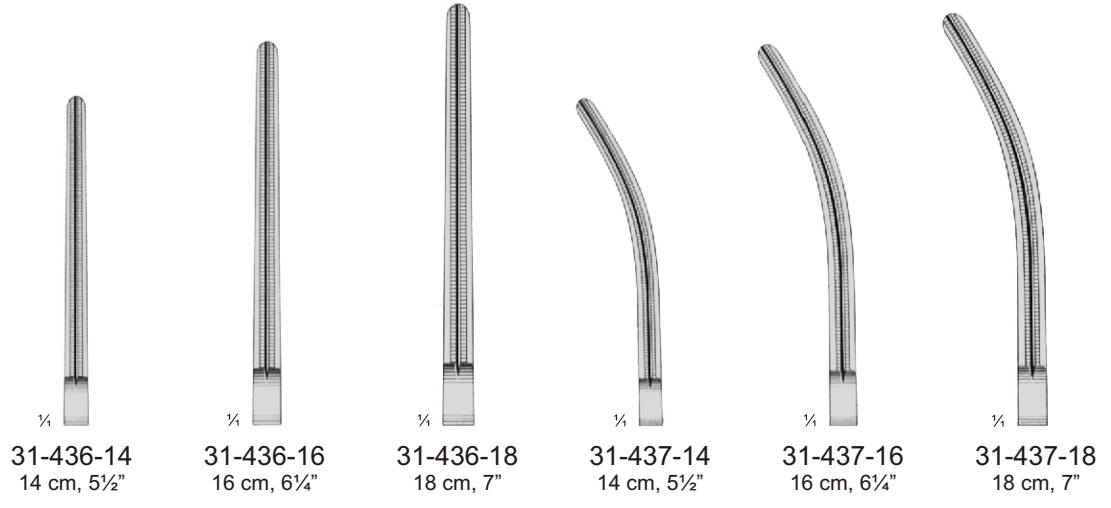
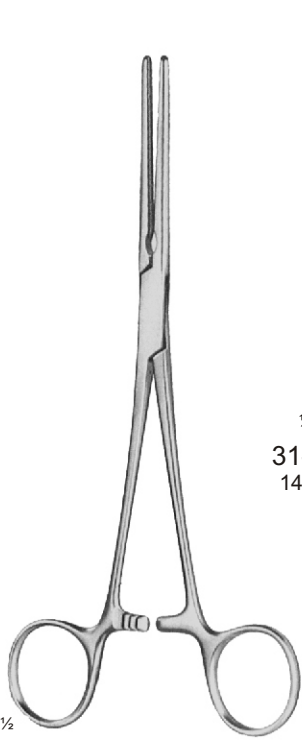
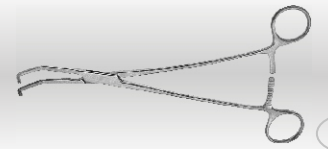

DE BAKEY-PEAN
 31-436-14
 31-437-18

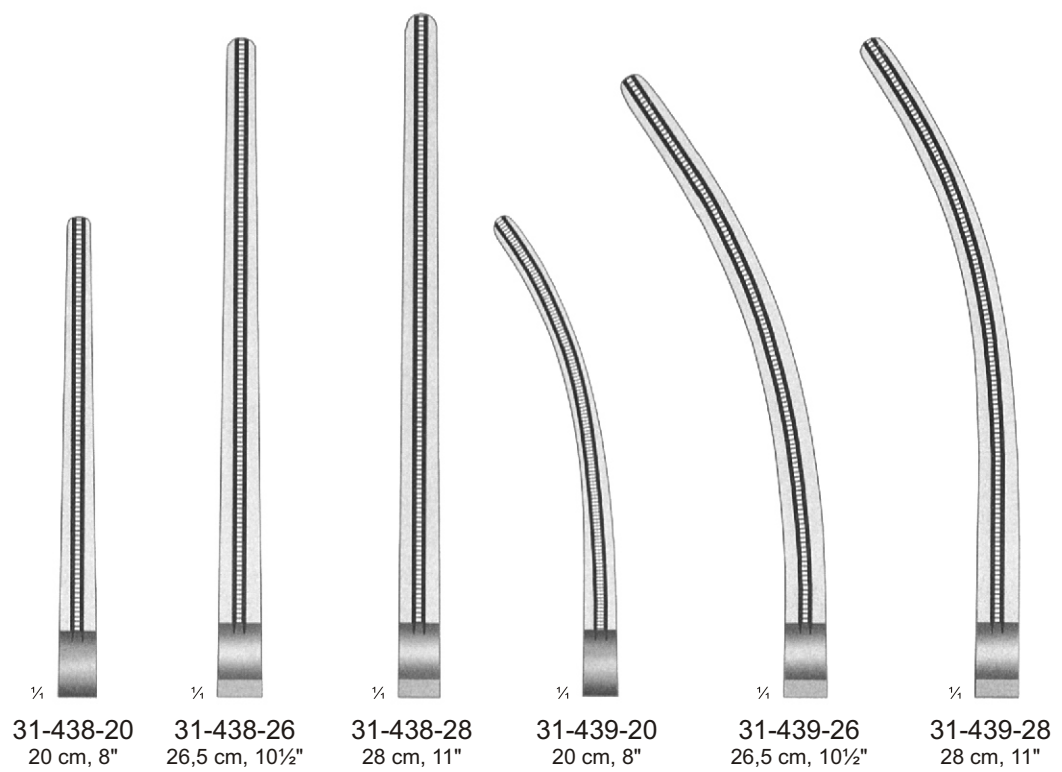

DE BAKEY-PEAN
 31-438-20
 31-439-28

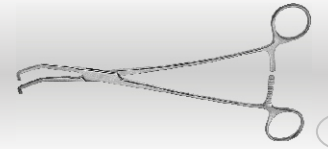

DE BAKEY
 31-441-01
 31-441-03



31-441-01
 16 cm, 6¼"



31-441-02
 15 cm, 6"



31-441-03
 15 cm, 6"

Multi-purpose clamps
 Mehrzweckklemmen
 Pinzas-clamps de varias aplicaciones
 Pincas-clamps universelles
 Pinze multiuso



DARDIK
 31-450-01
 31-454-05

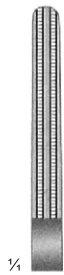

31-450-01
 15 cm, 6"

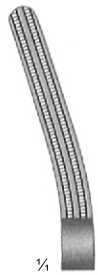

31-450-02
 15 cm, 6"

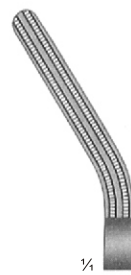

31-450-03
 15 cm, 6"



31-450-04
 14,5 cm, 5¾"

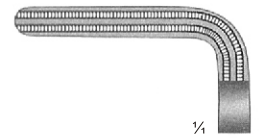

31-450-05
 13 cm, 5"

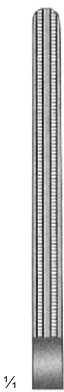

31-454-01
 16,5 cm, 6½"



31-454-02
 16,5 cm, 6½"

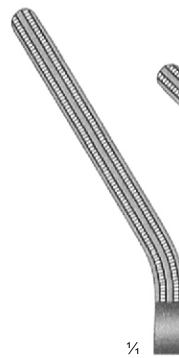

31-454-03
 16 cm, 6¼"



31-454-04
 16 cm, 5¼"



31-454-05
 13,5 cm, 5¼"

Peripheral Vascular Clamps with Toothing DE BAKEY

Peripheralklemmen mit DE BAKEY-Zahnung

Pinzas-clamps para vasos periféricos

Pinces-clamps vasculaires périphériques avec denture DE BAKEY

Pinze per vasi periferici con dentatura DE BAKEY

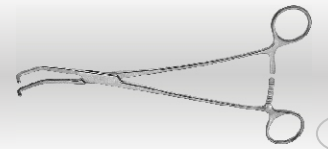

DALE
31-463-01
31-463-04

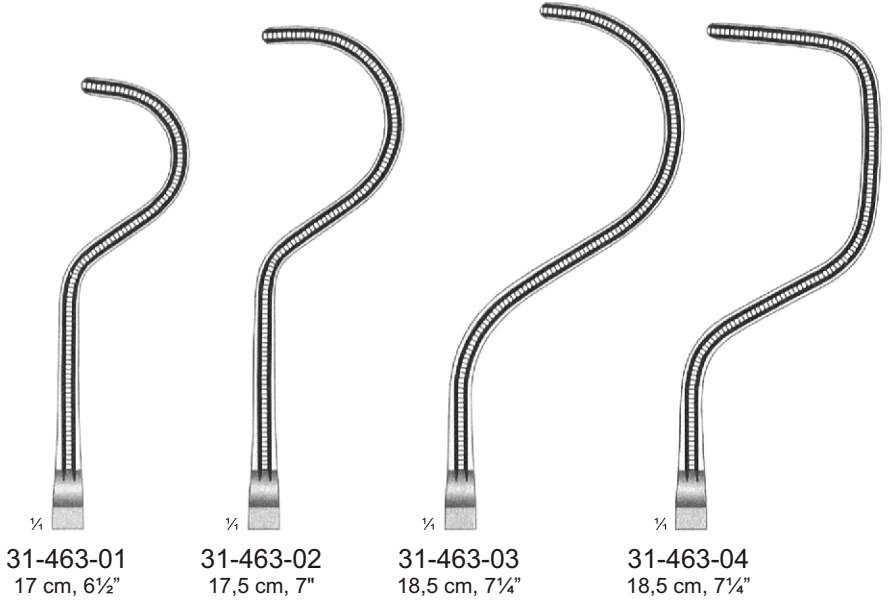

31-463-01
17 cm, 6½"

31-463-02
17,5 cm, 7"

31-463-03
18,5 cm, 7¼"

31-463-04
18,5 cm, 7¼"

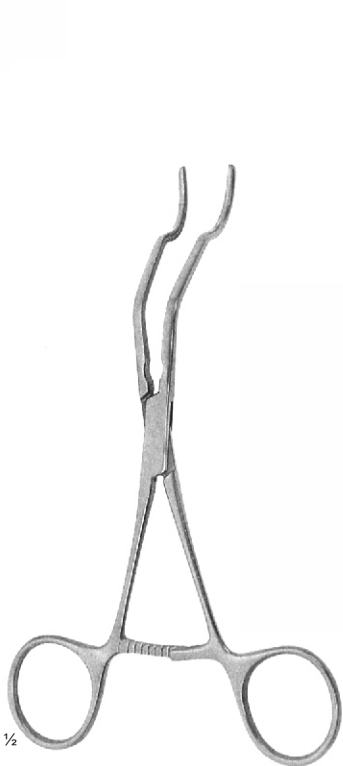

GREGORY
31-465-01
31-465-03

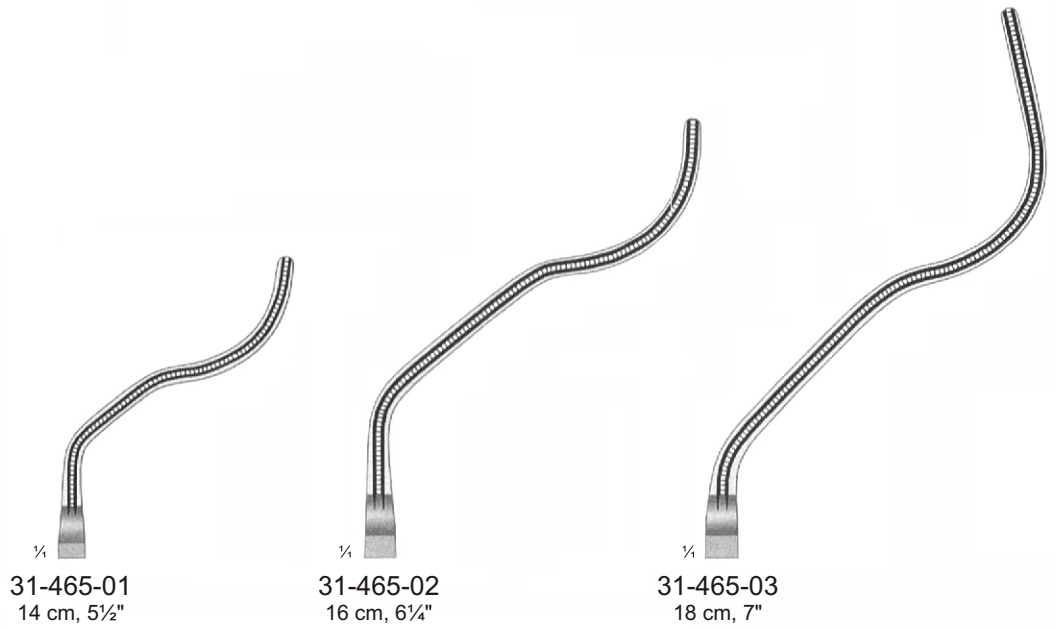

31-465-01
14 cm, 5½"

31-465-02
16 cm, 6¼"

31-465-03
18 cm, 7"

Profunda clamps
Profundaklemmen
Pinzas-clamps para la profunda
Pinces-clamps pour fémorale
Pinze per profondità

Coarctation Clamps with Toothig DE BAKEY

Coarctationsklemmen mit DE BAKEY-Zahnung
 Pinzas-clamps para coarctación con dentado DE BAKEY
 Pincés-clamps pour coarctation avec denture DE BAKEY
 Pinze per coartazione con dentatura DE BAKEY

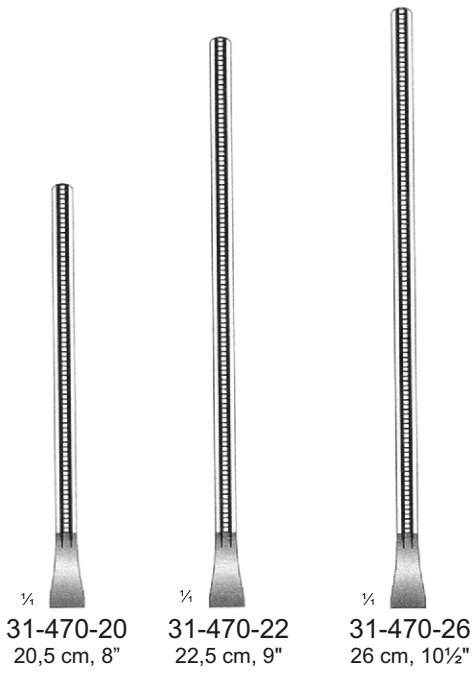
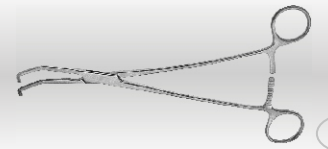

Peripheral Vascular Clamps with Toothing DE BAKEY

Peripheralklemmen mit DE BAKEY-Zahnung

Pinzas-clamps para vasos periféricos

Pinces-clamps vasculaires périphériques avec denture DE BAKEY

Pinze per vasi periferici con dentatura DE BAKEY

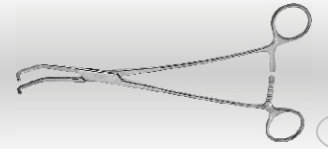

DE BAKEY
31-480-17
17 cm, 6 $\frac{3}{4}$ "

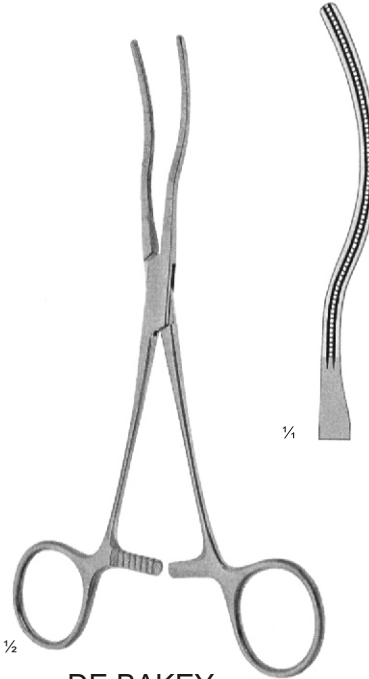

DE BAKEY
31-481-17
17 cm, 6 $\frac{3}{4}$ "

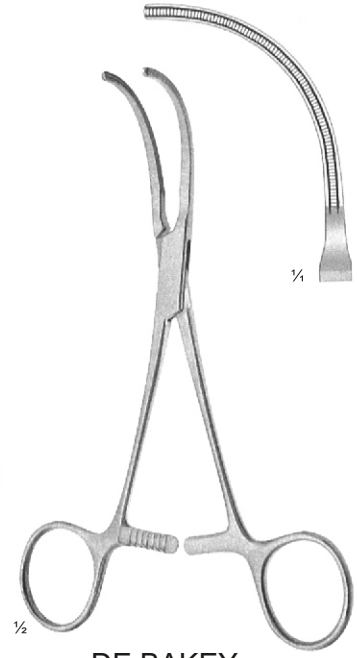

DE BAKEY
31-486-16
16 cm, 6 $\frac{1}{4}$ "



DE BAKEY
31-487-01
31-487-02

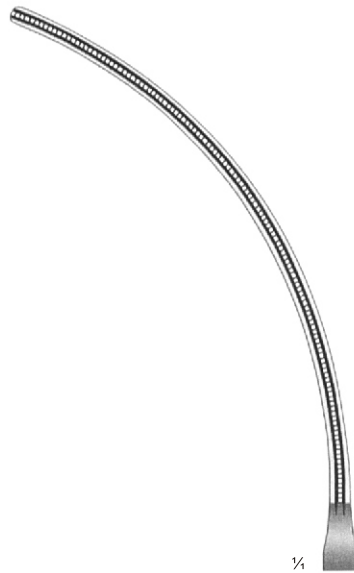

31-487-01
20 cm, 8"

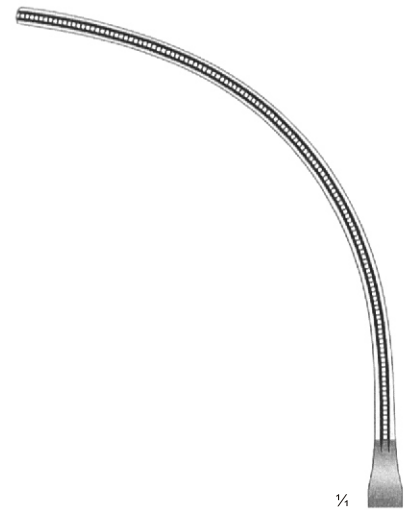

31-487-02
19 cm, 7 $\frac{1}{2}$ "

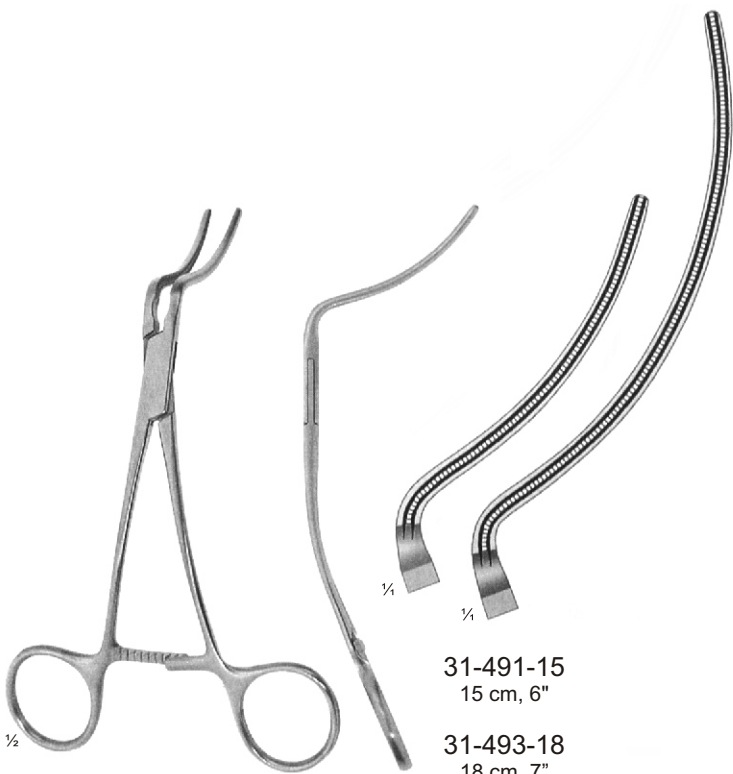
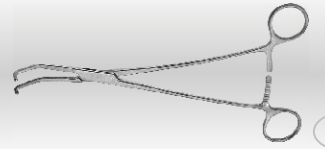

DE BAKEY
31-491-15
31-493-18

31-491-15
15 cm, 6"

31-493-18
18 cm, 7"

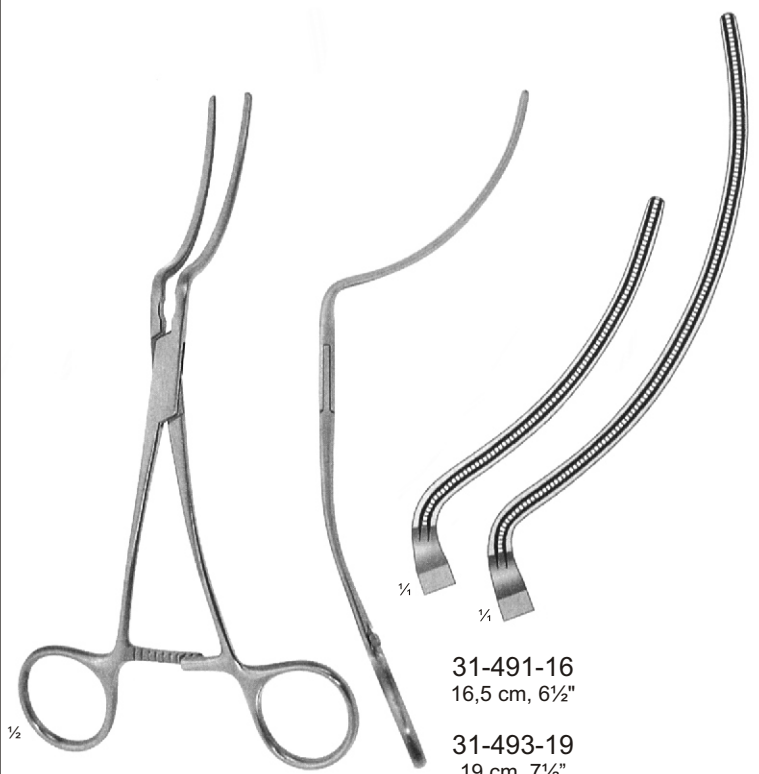

DE BAKEY
31-491-16
31-493-19

31-491-16
16,5 cm, 6½"

31-493-19
19 cm, 7½"

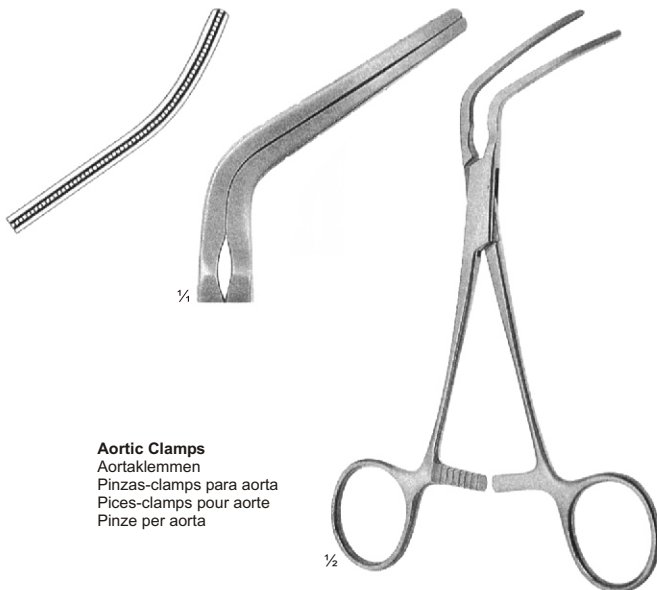

Aortic Clamps
Aortaklemmen
Pinzas-clamps para aorta
Pinces-clamps pour aorte
Pinze per aorta

SUBRAMANIAN
31-497-16
16 cm, 6¼"

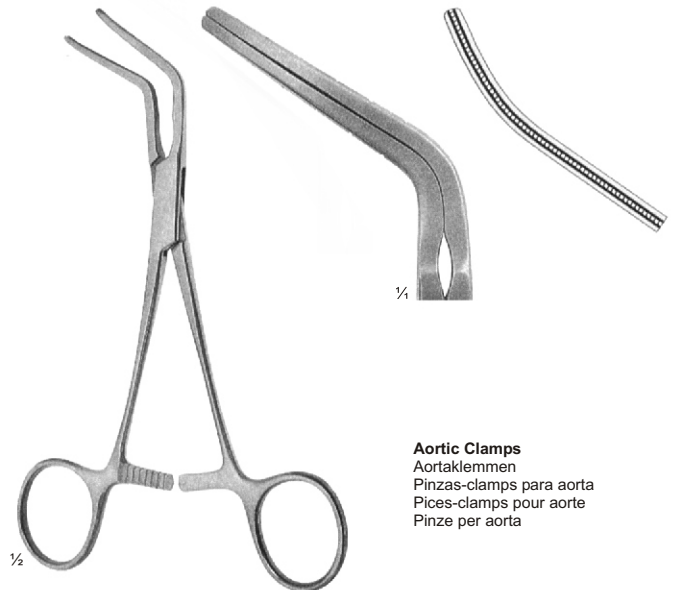

Aortic Clamps
Aortaklemmen
Pinzas-clamps para aorta
Pinces-clamps pour aorte
Pinze per aorta

SUBRAMANIAN
31-499-16
16 cm, 6¼"

Coarctation Clamps with Tothing DE BAKEY

Coarctationsklemmen mit DE BAKEY-Zahnung
 Pinzas-clamps para coarctación con dentado DE BAKEY
 Pince-clamps pour coarctation avec denture DE BAKEY
 Pinze per coartazione con dentatura DE BAKEY

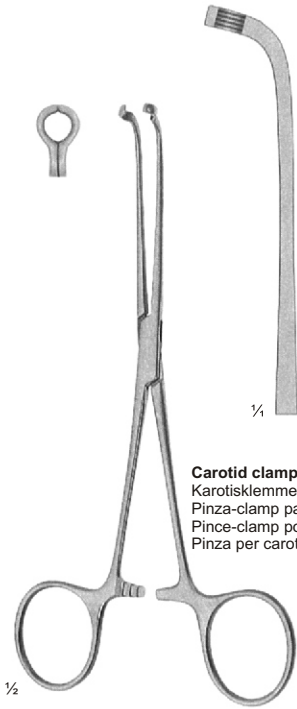
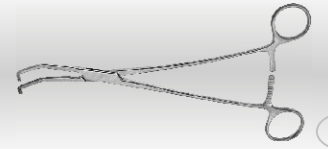

Carotid clamp
 Karotisklemme
 Pinza-clamp para carótida
 Pince-clamp pour la carotide
 Pinza per carotide

JAVID
 31-500-18
 18 cm, 7"

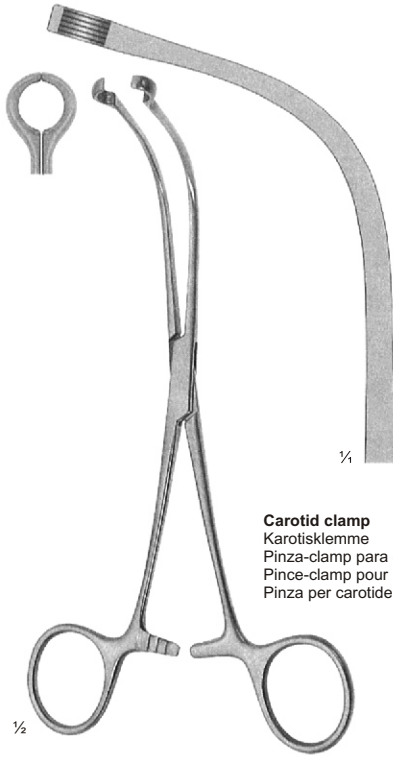

Carotid clamp
 Karotisklemme
 Pinza-clamp para carótida
 Pince-clamp pour la carotide
 Pinza per carotide

JAVID
 31-506-19
 19 cm, 7½"

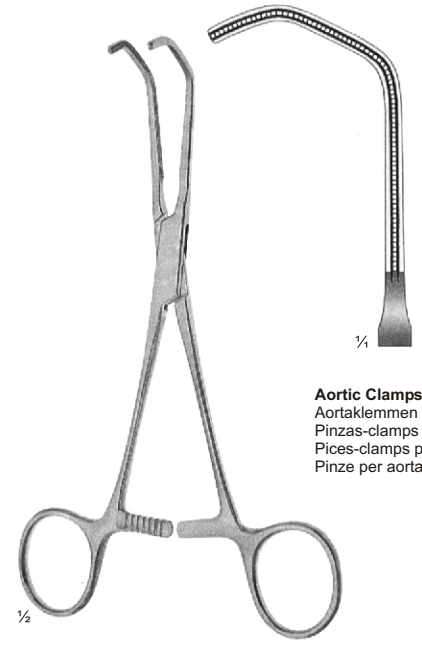

Aortic Clamps
 Aortaklemmen
 Pinzas-clamps para aorta
 Pices-clamps pour aorte
 Pinze per aorta

DE BAKLEY-BECK
 31-508-17
 17 cm, 6¾"



DE BAKLEY
 31-511-20
 20 cm, 8"



Renal artery clamp
 Nierenarterienklemme
 Pinza-clamp para arteria renal
 Pince hémostatique rénale
 Pinza emostatica per arteria renale



BAILEY
 31-516-22
 31-516-23

31-516-23
 23 cm, 9"

31-516-22
 22 cm, 8¾"

Coarctation Clamps with Tothing DE BAKEY

Coarctationsklemmen mit DE BAKEY-Zahnung
 Pinzas-clamps para coarctación con dentado DE BAKEY
 Pinces-clamps pour coarctation avec denture DE BAKEY
 Pinze per coartazione con dentatura DE BAKEY

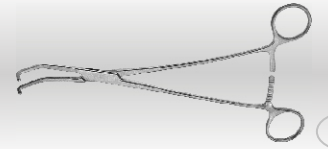

1/2

BAILEY
 31-519-19
 31-519-23

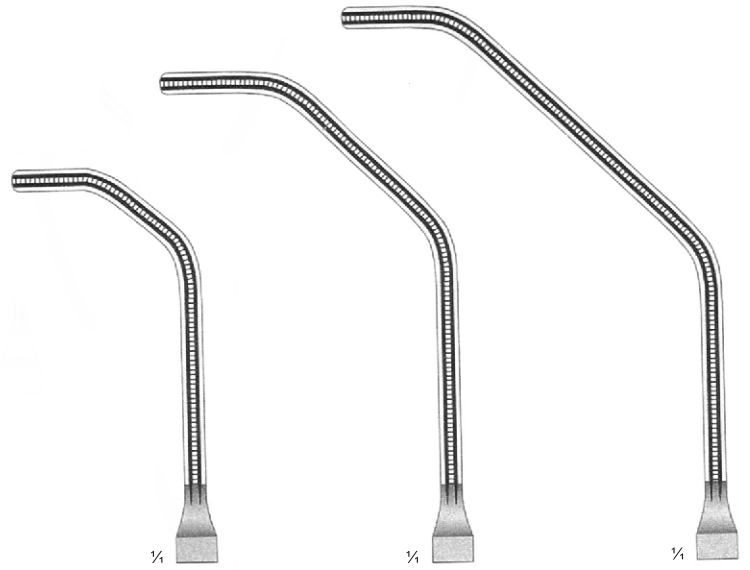

1/4
31-519-19
 19,5 cm, 7 3/4"

1/4
31-519-21
 21,5 cm, 8 1/2"

1/4
31-519-23
 23 cm, 9"



1/2

BAILEY
 31-529-20
 31-529-23

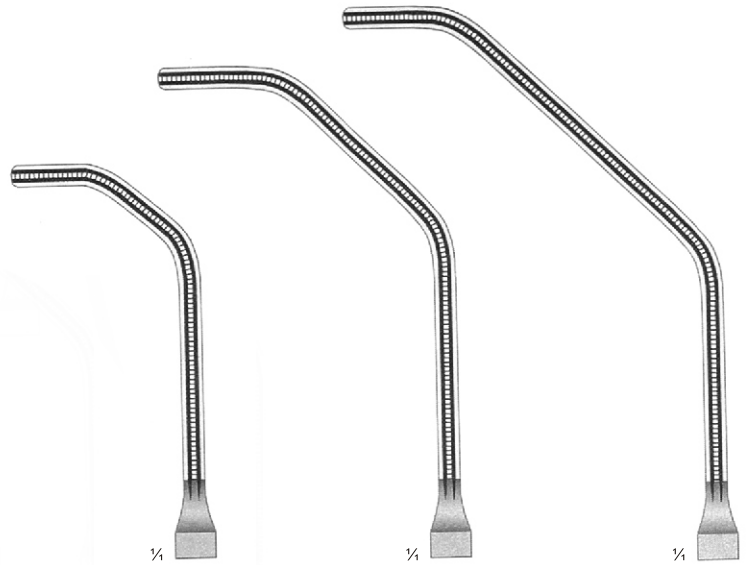

1/4
31-529-20
 20,5 cm, 8"

1/4
31-529-22
 22 cm, 8 3/4"

1/4
31-529-23
 23 cm, 9"

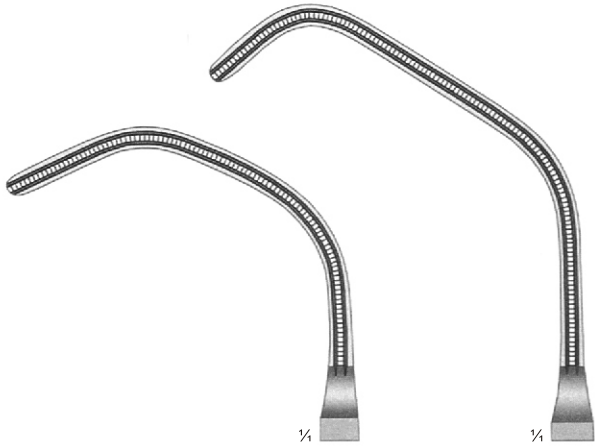
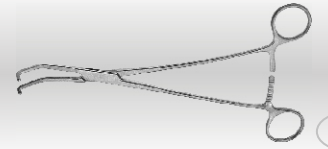

DIETRICH
 31-539-21
 21 cm, 8¼"

OCHSNER
 31-539-23
 23,5 cm, 9¼"



DIETRICH
 31-539-21
 31-539-23



DE BAKEY
 31-551-27
 27 cm, 10½"



Artic clamps with Toothing DE BAKEY
Aortaklemmen mit DE BAKEY-Zahnung
Pinzas-clamps para aorta con dentado DE BAKEY
Pinces-clamps pour aorte avec denture DE BAKEY
Pinze per aorta con dentatura DE BAKEY

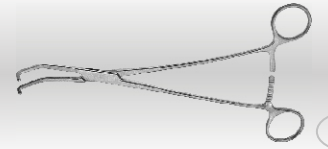

031



DE BAKEY-MORRIS
31-561-18
31-561-25

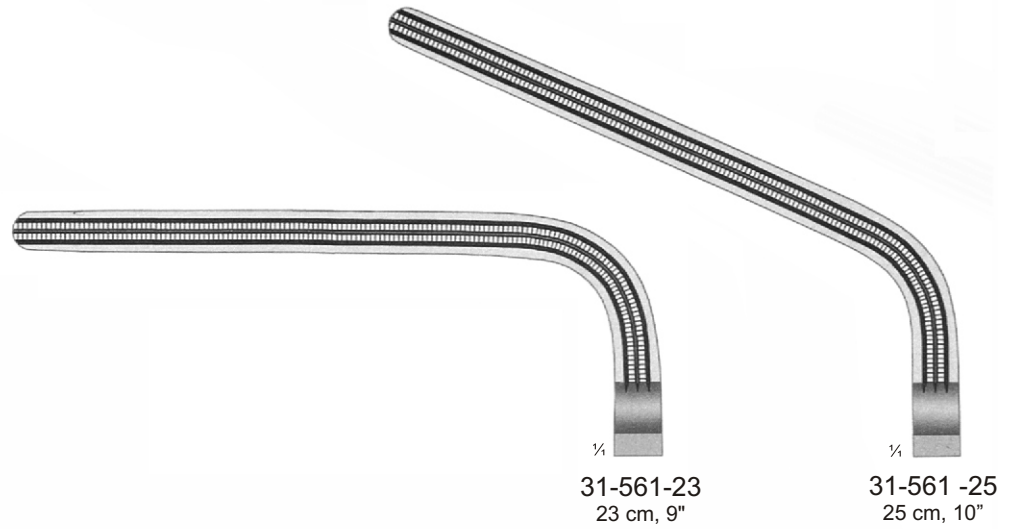

Tangential Occlusion Clamps

Gefäßklemmen für Tangential-Verschluss
 Pinzas-clamps para oclusión tangencial
 Pinces vasculaires pour occlusion tangencielle
 Pinze vascolari per occlusione tangenziale

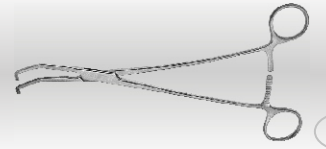

DE BAKEY
 31-571-01
 31-571-05

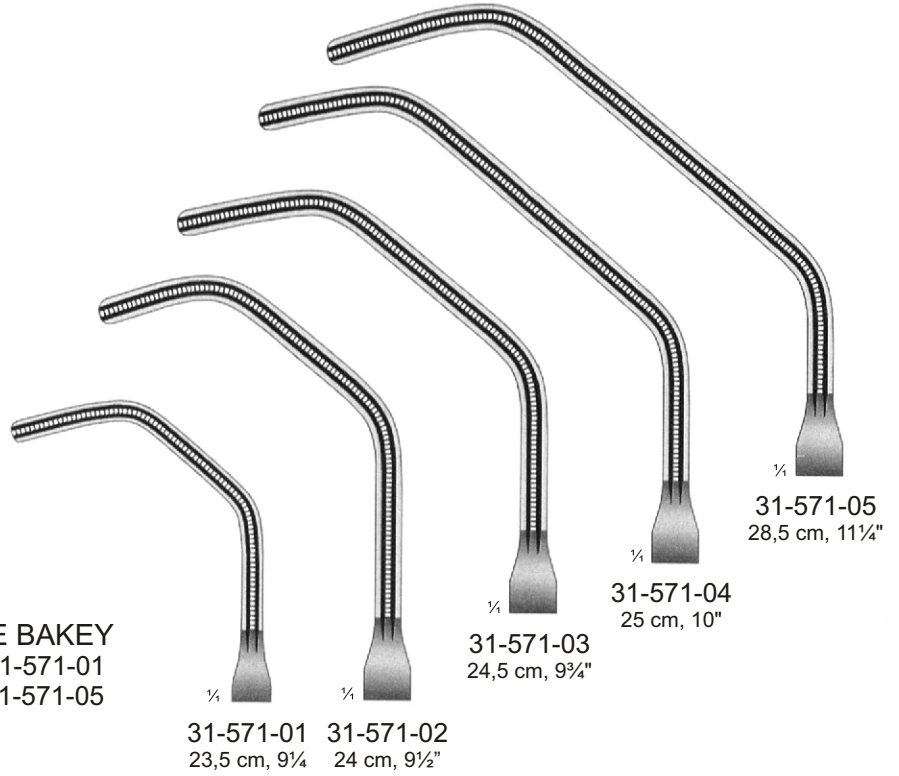

31-571-01 31-571-02
 23,5 cm, 9 $\frac{1}{4}$ " 24 cm, 9 $\frac{1}{2}$ "

31-571-03
 24,5 cm, 9 $\frac{3}{4}$ "

31-571-04
 25 cm, 10"

31-571-05
 28,5 cm, 11 $\frac{1}{4}$ "



DE BAKEY
 SATINSKY
 31-581-01
 31-581-05

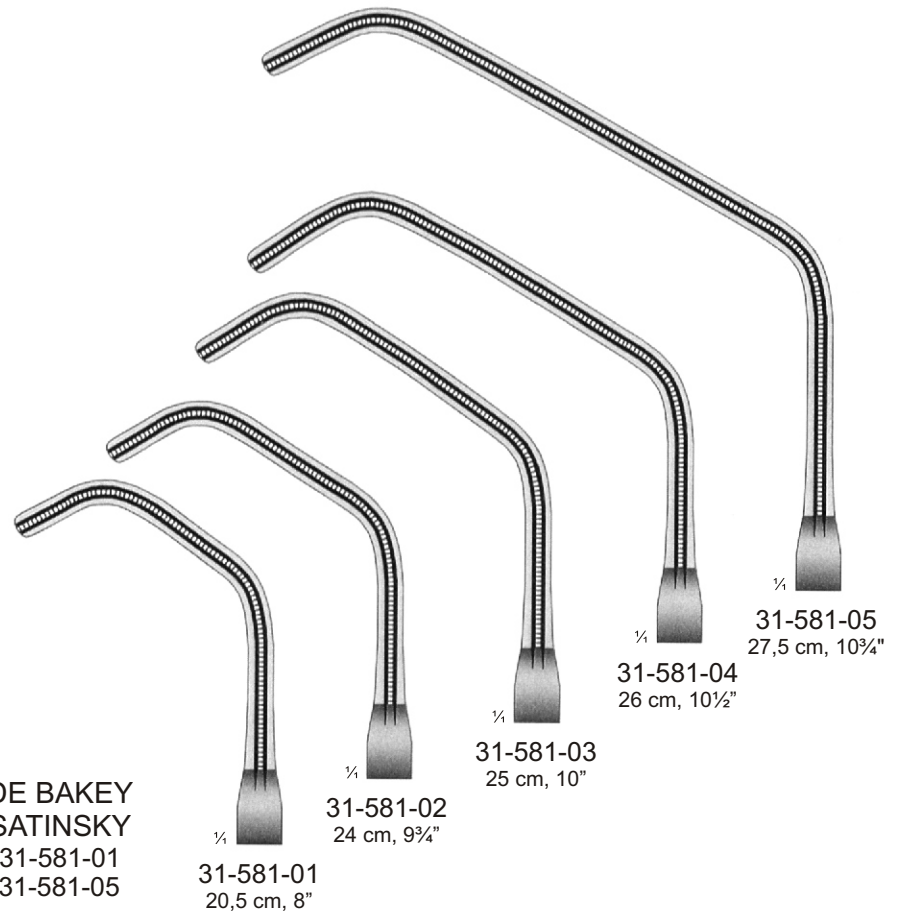

31-581-01
 20,5 cm, 8"

31-581-02
 24 cm, 9 $\frac{3}{4}$ "

31-581-03
 25 cm, 10"

31-581-04
 26 cm, 10 $\frac{1}{2}$ "

31-581-05
 27,5 cm, 10 $\frac{3}{4}$ "

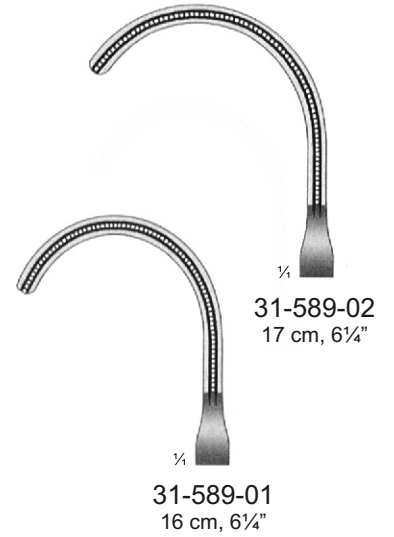
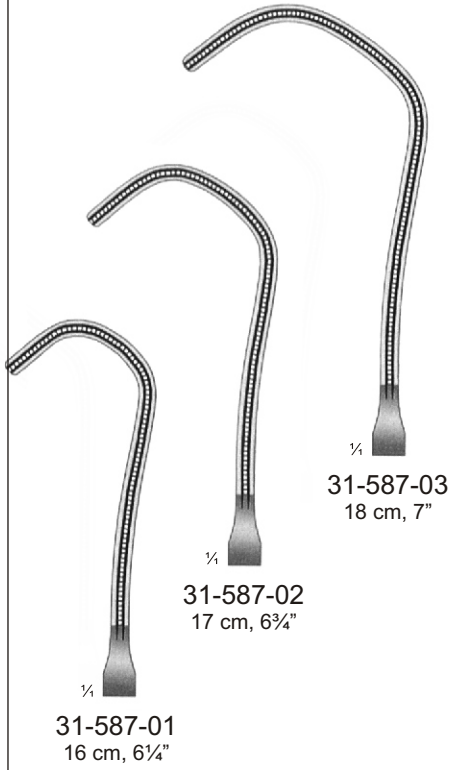
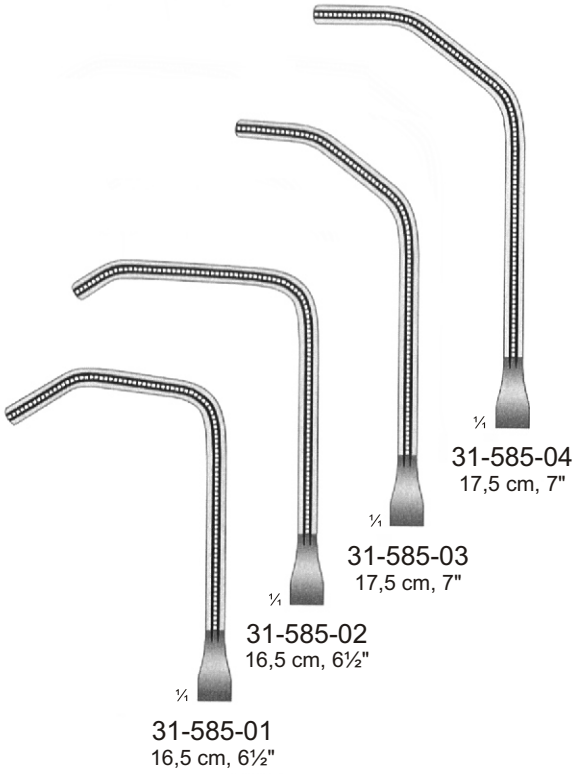
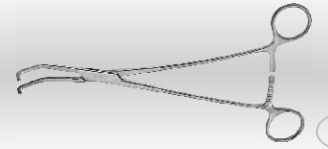

DE BAKEY-REYNOLDS
 31-585-01
 31-585-04



DE BAKEY-DERRA
 31-587-01
 31-587-03



DE BAKEY-BECK
 31-589-01
 31-589-02

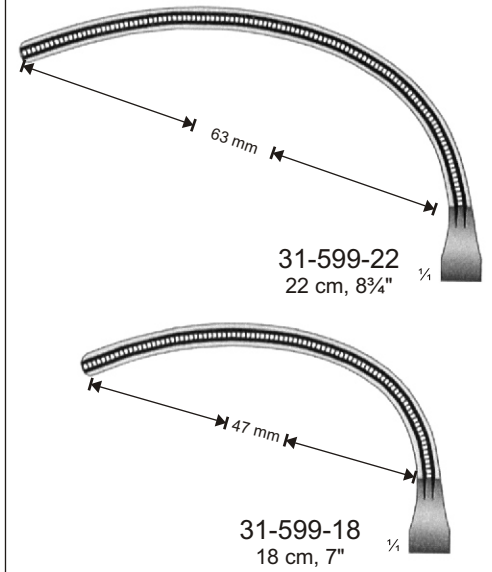
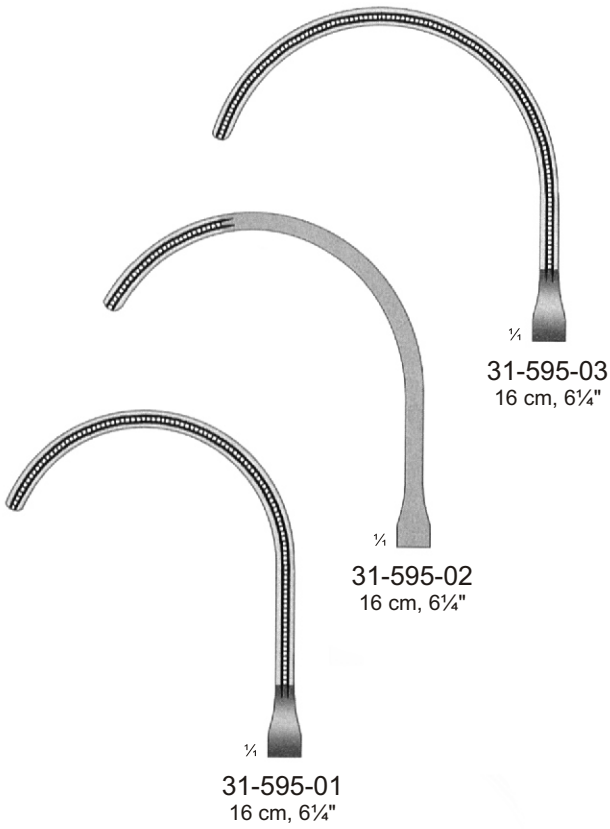
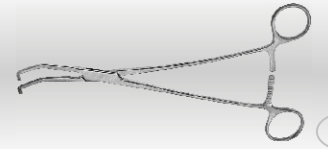

DE BAKEY
 31-595-01
 31-595-03

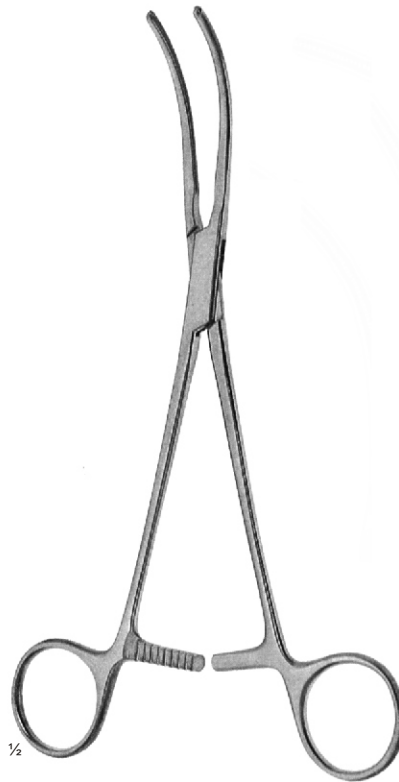

GLOVER
 31-597-01
 31-597-02



GLOVER
 31-599-18
 31-599-22

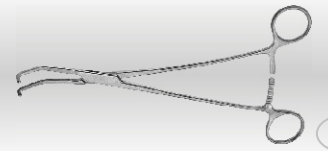

For Temporary occlusion of the arteria iliaca
 Für temporären Verschuß der Iliac-Arterie
 Para la oclusión temporal de la arteria iliac
 Pour occlusion temporaire de l'artere iliaque
 Per l'occlusione temporanea dell'arteria iliaca

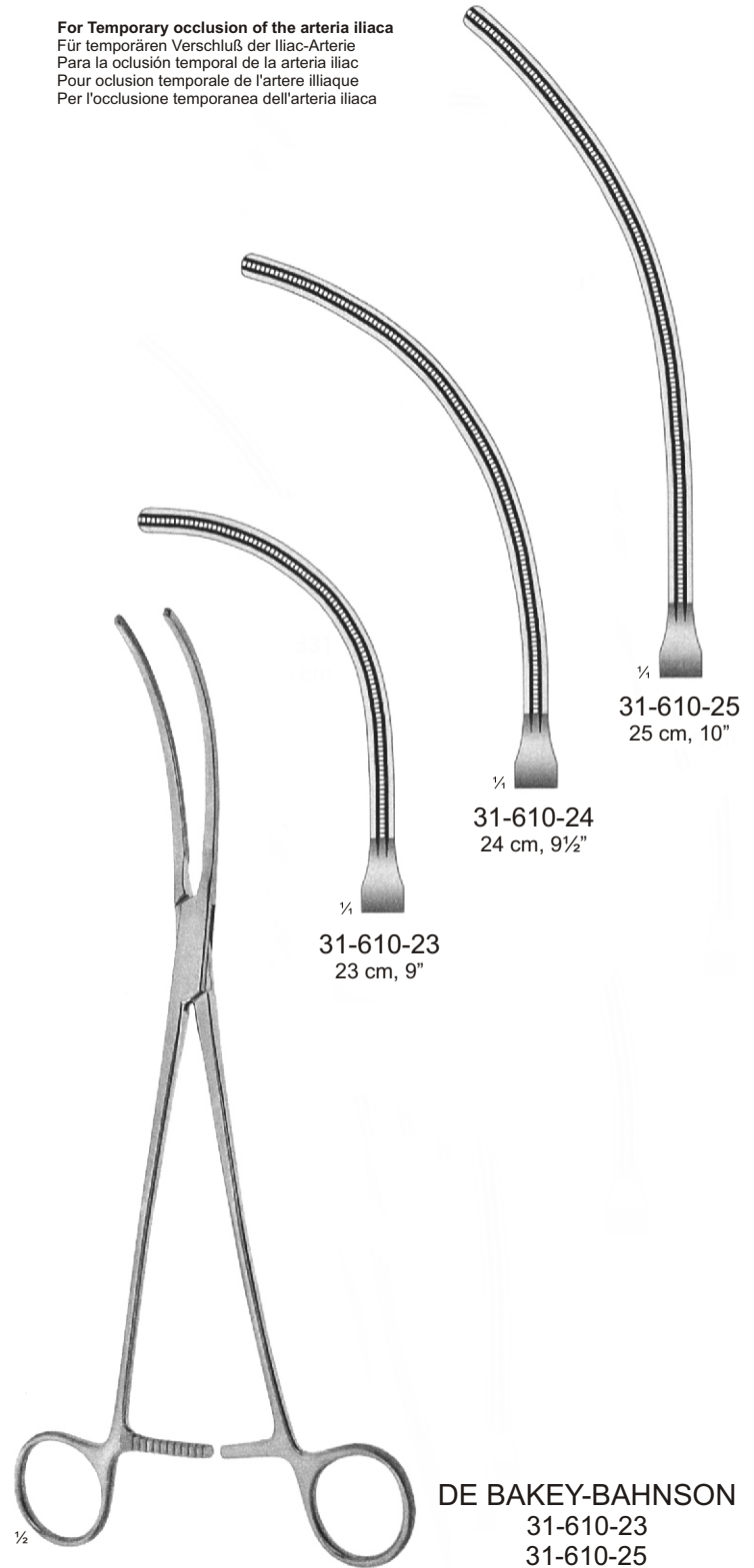

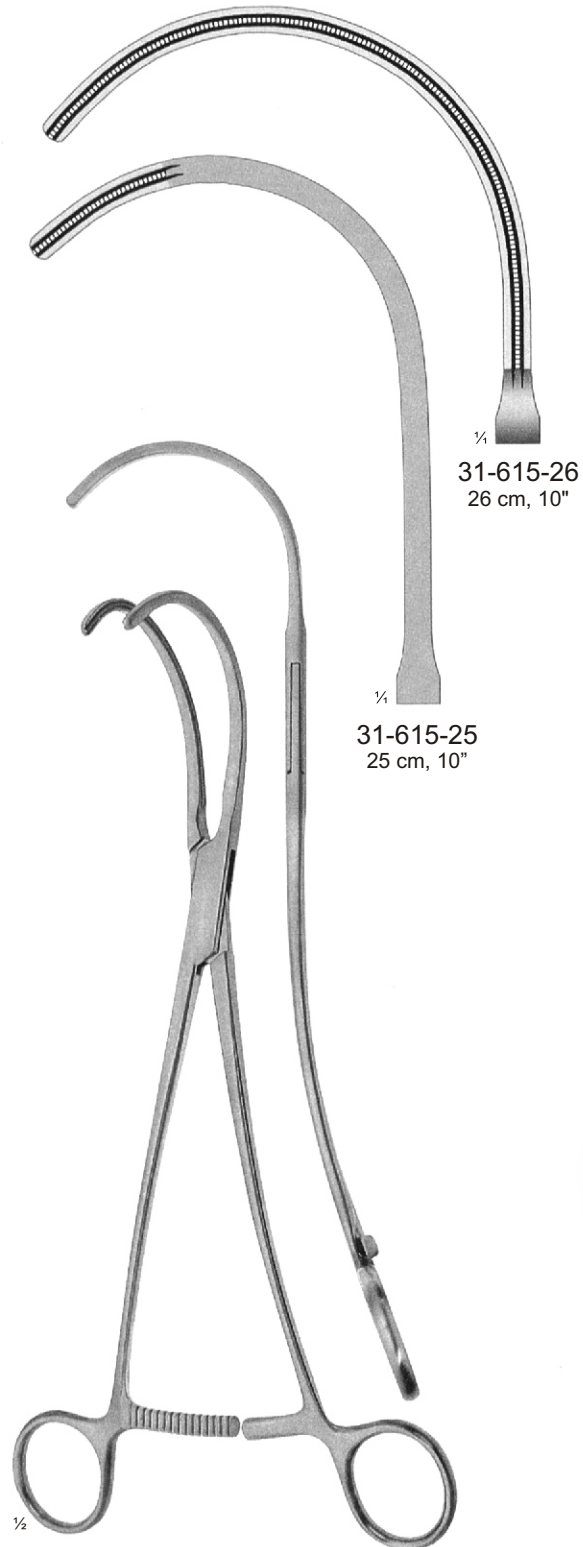
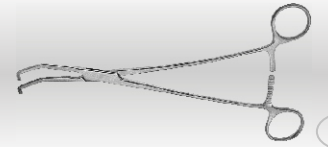

31-615-26
26 cm, 10"

31-615-25
25 cm, 10"

DE BAKEY
31-615-25
31-615-26



31-617-21
21 cm, 8 1/4"

31-617-20
20 cm, 8"

LAMBERT-KAY
31-617-20
31-617-21

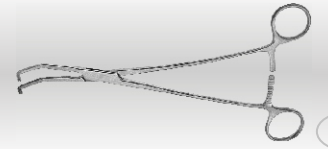

DE BAKEY-CRAFOORD
 31-629-23
 31-629-26

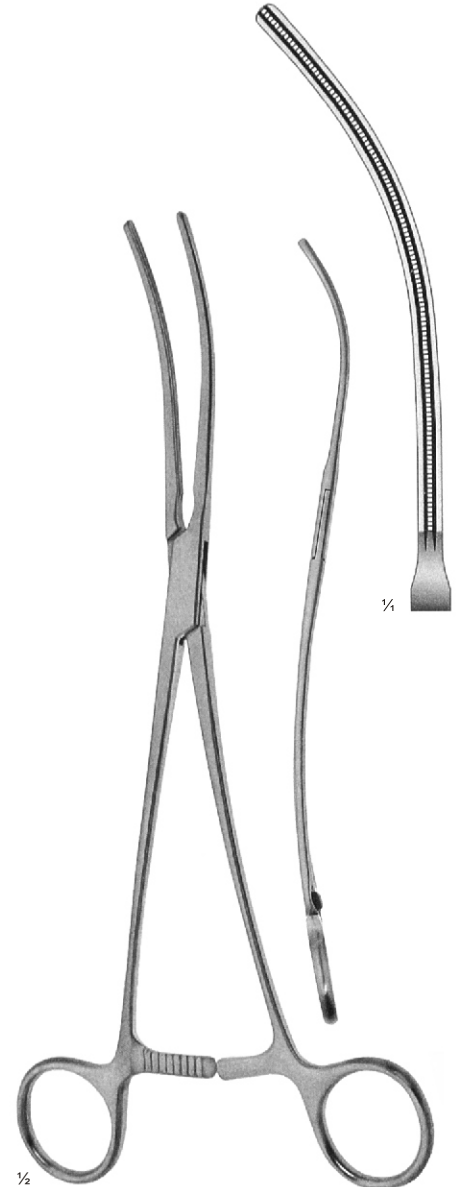

DE BAKEY-CRAFOORD
 31-631-26
 26 cm, 10 1/4"

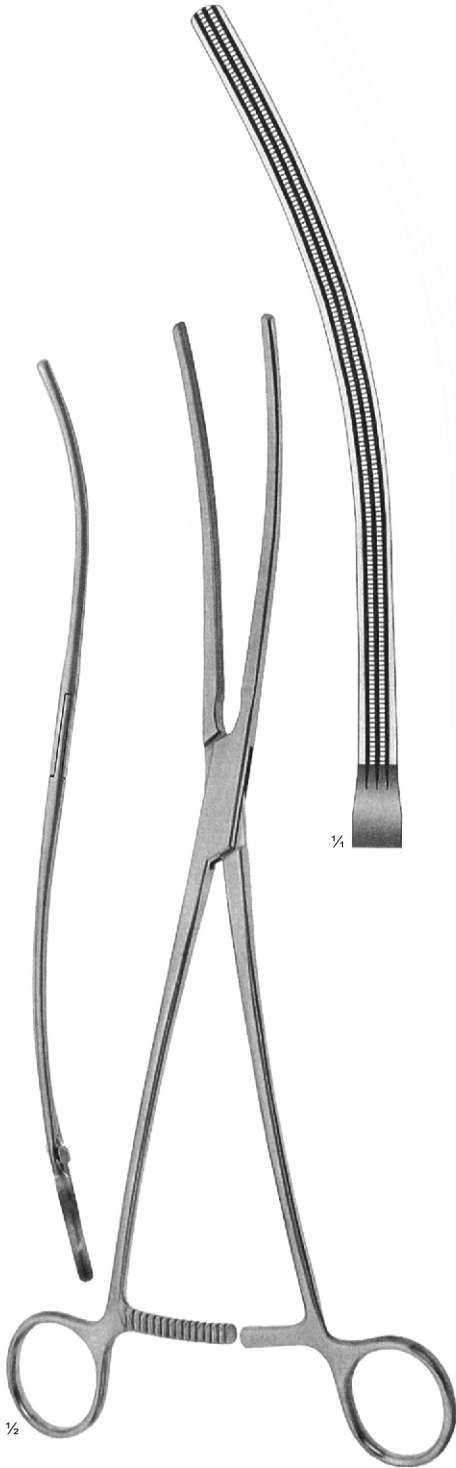
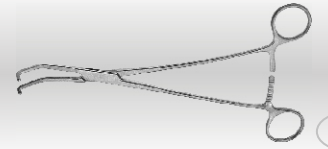

DE BAKEY
 31-645-30
 30 cm, 11 $\frac{3}{4}$ "



31-641-26
 26 cm, 10 $\frac{1}{4}$ "

31-641-27
 27 cm, 10 $\frac{1}{2}$ "

31-641-31
 31 cm, 12 $\frac{1}{4}$ "

31-641-33
 33 cm, 13"

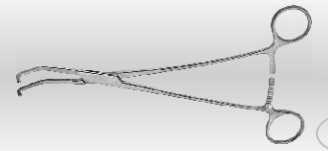

DE BAKEY
 31-651-01
 31-651-06

Dissecting and Ligature Forceps with Toothing DE BAKEY
 Präparier- und Ligaturklemmen mit BAKEY-Zahnung
 Pinzas para disección y ligaduras con dentado DE BAKEY
 Pincas à disséquer et à ligatures avec denture DE BAKEY
 Pinze per dissezione e legatura con dentatura DE BAKEY

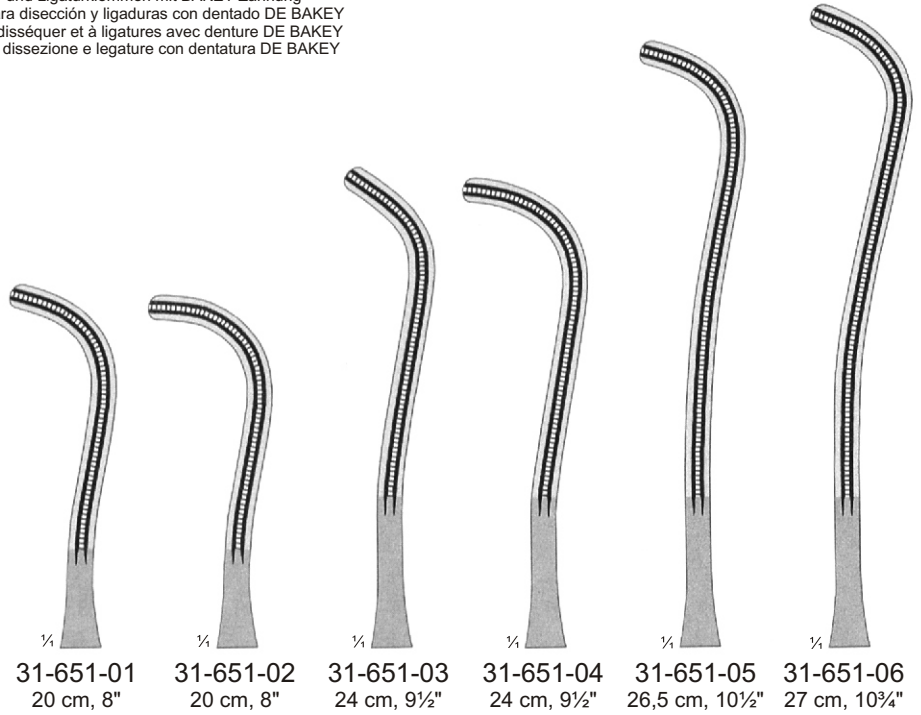

1/4	1/4	1/4	1/4	1/4	1/4
31-651-01	31-651-02	31-651-03	31-651-04	31-651-05	31-651-06
20 cm, 8"	20 cm, 8"	24 cm, 9½"	24 cm, 9½"	26,5 cm, 10½"	27 cm, 10¾"



DE BAKEY-BECK
 31-671-19
 31-671-21



1/4	1/4
31-671-19	31-671-21
19 cm, 7½"	21 cm, 8¼"



WYLIE
 31-677-22
 31-677-23



1/4
31-677-22
22,5 cm, 9"
1/4
31-677-23
23 cm, 9"

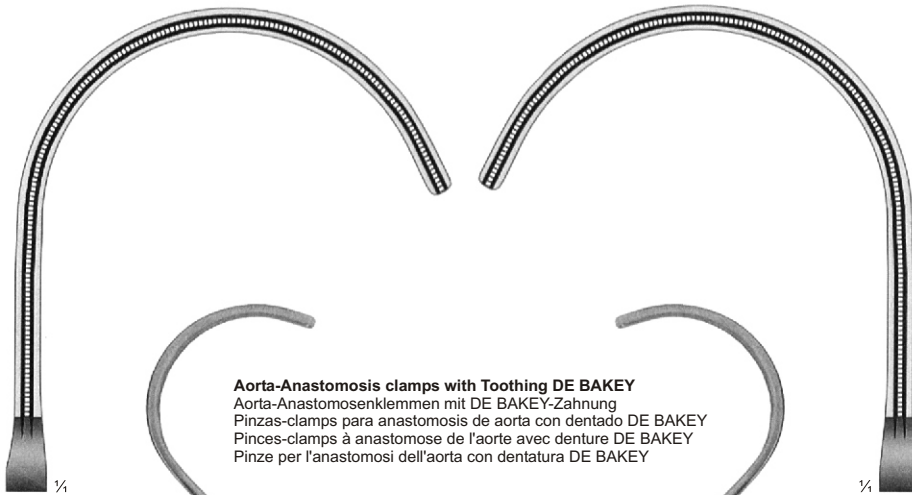
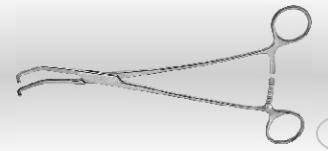

Aorta-Anastomosis clamps with Toothing DE BAKEY
 Aorta-Anastomosenklemmen mit DE BAKEY-Zahnung
 Pinzas-clamps para anastomosis de aorta con dentado DE BAKEY
 Pinces-clamps à anastomose de l'aorte avec denture DE BAKEY
 Pinze per l'anastomosi dell'aorta con dentatura DE BAKEY

¼

¼

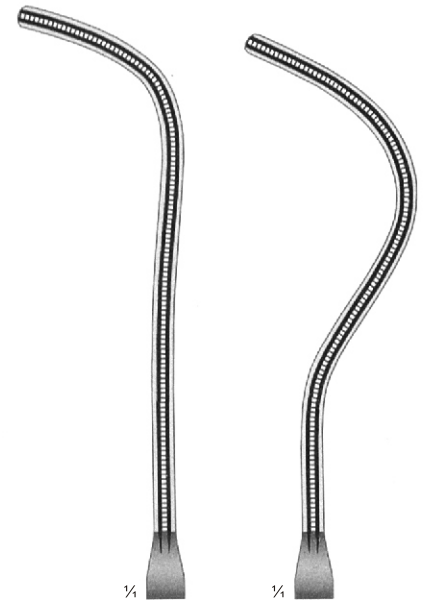

¼

¼

31-685-24
 24 cm, 9¼"

31-687-24
 24 cm, 9½"

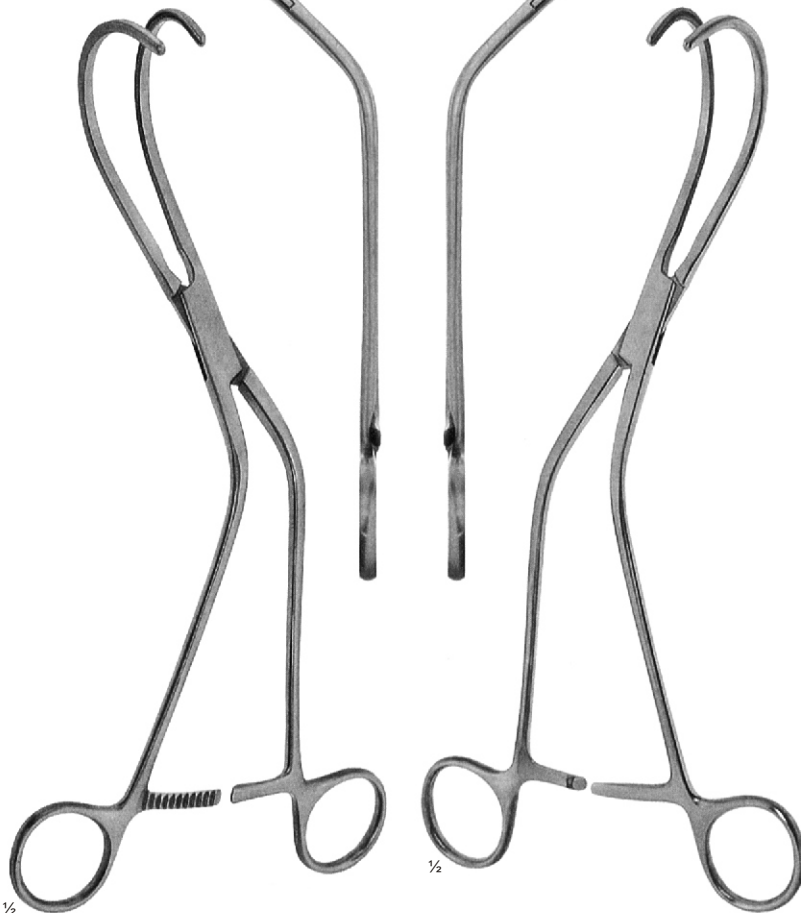

½

½

WEBER Left
 Links
 Izquierda
 à gauche
 sinistra
31-681-26
 26 cm, 10¼"

WEBER Right
 Rechts
 Derecha
 à droite
 Destra
31-683-26
 26 cm, 10¼"



½

DE BAKEY-HARKEN
31-685-24
31-687-24

Bronchus Clamps with Toothing DE BAKEY

Bronchusklemmen mit DE BAKEY-Zahnung
 Pinzas-clamps bronquiales con dentado DE BAKEY
 Pincas-clamps à bronches avec denture DE BAKEY
 Pinze per bronchi con dentatura DE BAKEY

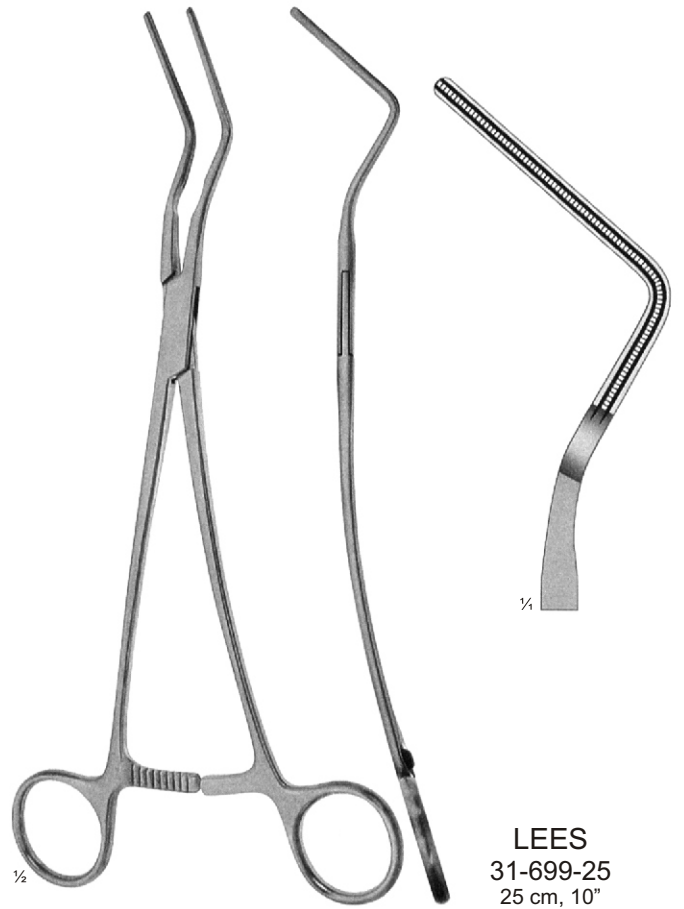
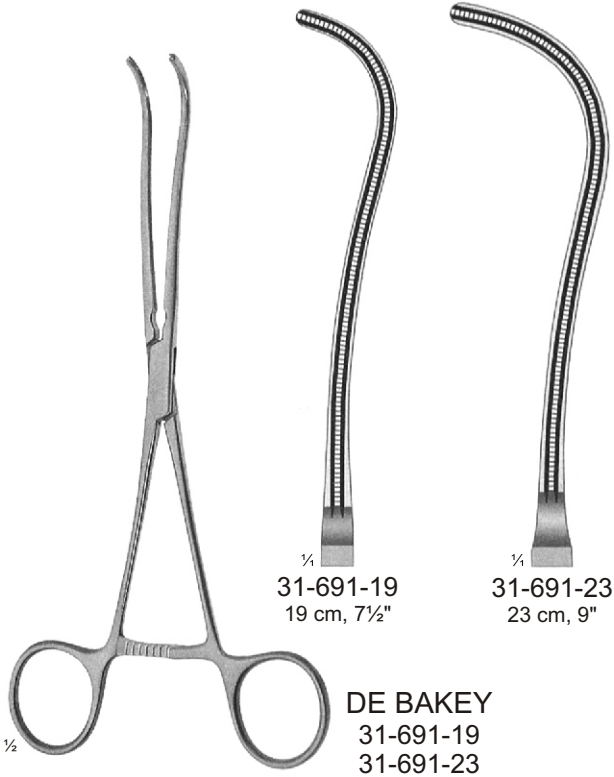
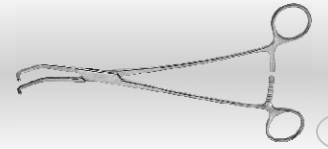



Multi-Purpose Clamps with Toothing DE BAKEY

Mehrzweckklemmen mit DE BAKEY-Zahnung

Pinzas-clamps de varieas aplicaciones con dentado DE BAKEY

Pinces-clamps universelles avec denture DE BAKEY

Pinze multiuso con dentatura DE BAKEY

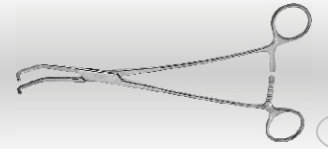

031

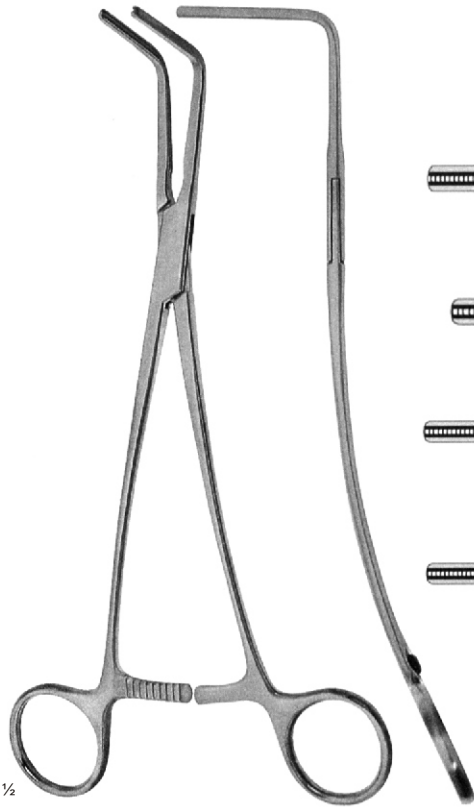

1/2

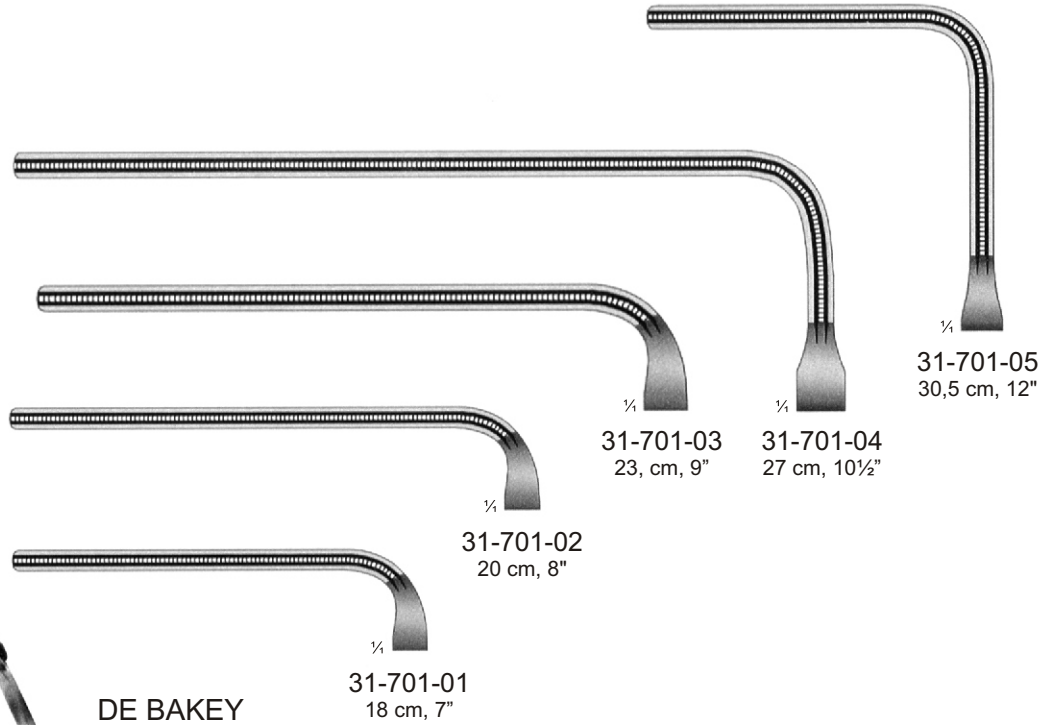

DE BAKEY
31-701-01
31-701-05

31-701-01
18 cm, 7"

31-701-02
20 cm, 8"

31-701-03
23 cm, 9"

31-701-04
27 cm, 10 1/2"

31-701-05
30,5 cm, 12"

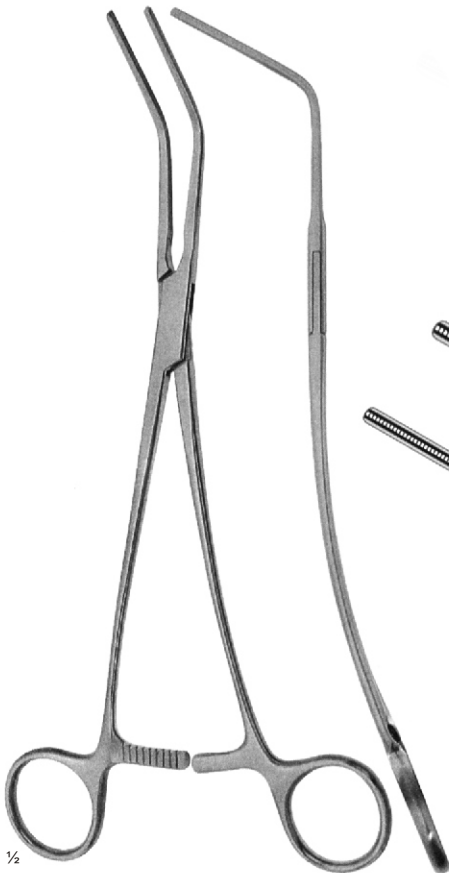

1/2

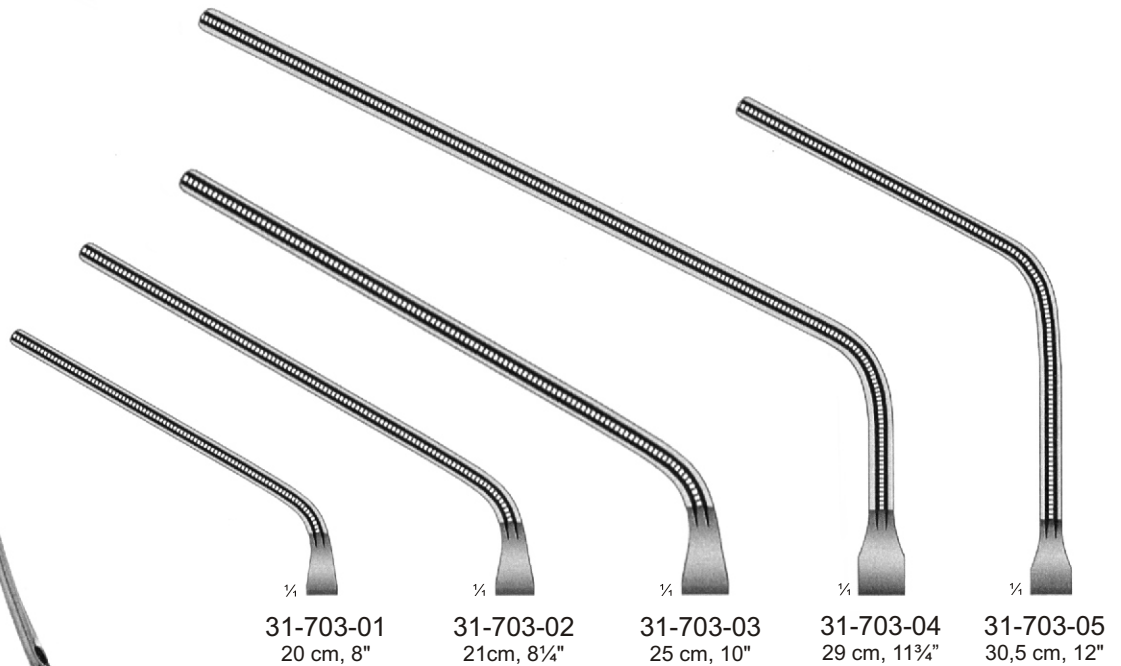

DE BAKEY
31-703-01
31-703-05

31-703-01
20 cm, 8"

31-703-02
21cm, 8 1/4"

31-703-03
25 cm, 10"

31-703-04
29 cm, 11 1/4"

31-703-05
30,5 cm, 12"

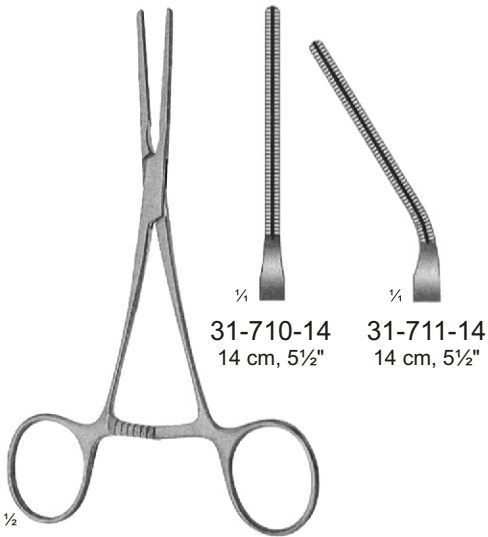
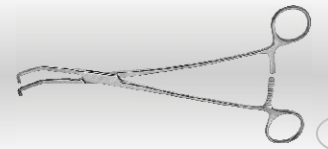

31-710-14
14 cm, 5½"

31-711-14
14 cm, 5½"

COOLEY
31-710-14
31-711-14

For pediatric surgery
 Für kinderchirurgie
 Para la pediatria
 Pour chirurgie Pédiatrique
 Per chirurgia pediatrica

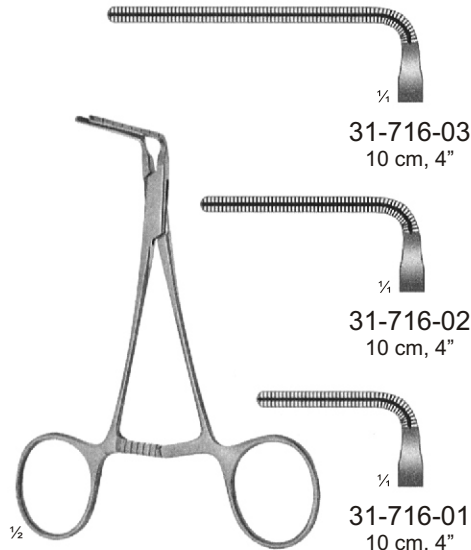

31-716-03
10 cm, 4"

31-716-02
10 cm, 4"

31-716-01
10 cm, 4"

COOLEY
31-716-01
31-716-03

For pediatric surgery
 für kinderchirurgie
 Para la pediatria
 Pour chirurgie Pédiatrique
 Per chirurgia pediatrica



COOLEY
31-721-14
14 cm, 5½"

For pediatric surgery
 für kinderchirurgie
 Para la pediatria
 Pour chirurgie Pédiatrique
 Per chirurgia pediatrica



COOLEY
31-725-14
14 cm, 5½"

For pediatric surgery
 für kinderchirurgie
 Para la pediatria
 Pour chirurgie Pédiatrique
 Per chirurgia pediatrica

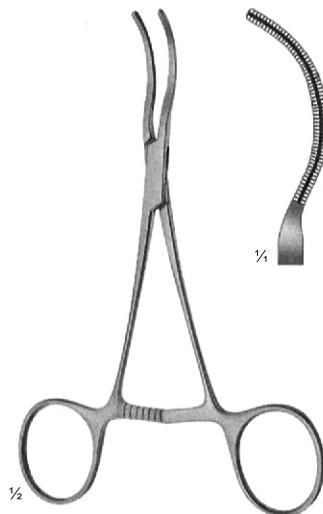

COOLEY
31-729-14
14 cm, 5½"

For pediatric surgery
 für kinderchirurgie
 Para la pediatria
 Pour chirurgie Pédiatrique
 Per chirurgia pediatrica

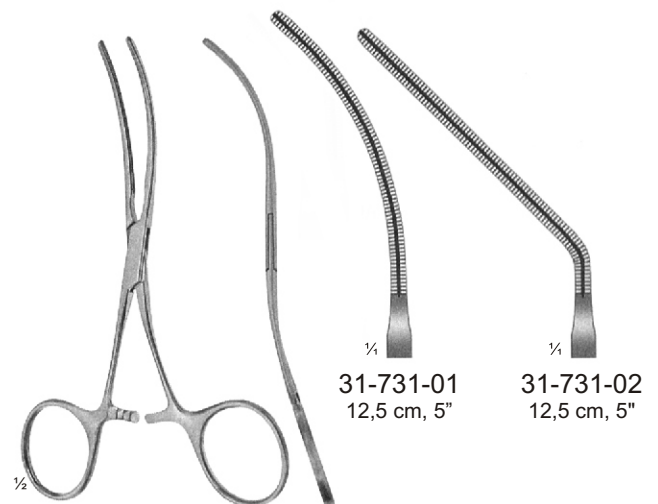

31-731-01
12,5 cm, 5"

31-731-02
12,5 cm, 5"

COOLEY
31-731-01
31-731-02

Bulldog clamp
 Bulldogklemme
 Clamp Bulldog
 Clamp Bulldog
 Pinza Bulldog

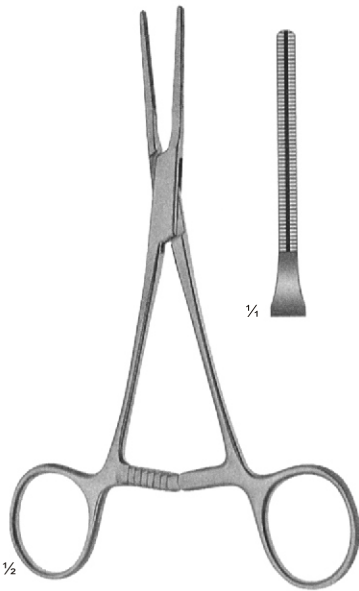
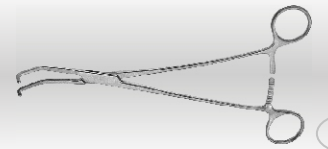

COOLEY
 31-734-15
 15 cm, 6"

Patent ductus clamp
 Patent-Ductusklemme
 Pinza patente de conducto
 Clamp patent-ductus droit
 Clamp patent per dotto

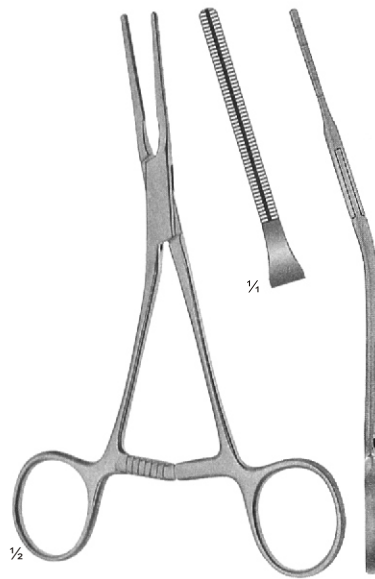

COOLEY
 31-735-15
 15 cm, 6"

Patent ductus clamp
 Patent-Ductusklemme
 Pinza patente de conducto
 Clamp patent-ductus droit
 Clamp patent per dotto



31-745-03
 15 cm, 6"

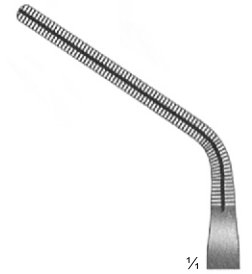

31-745-02
 15,5 cm, 6¼"

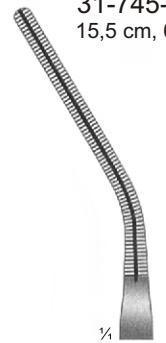

31-745-01
 17 cm, 6¾"

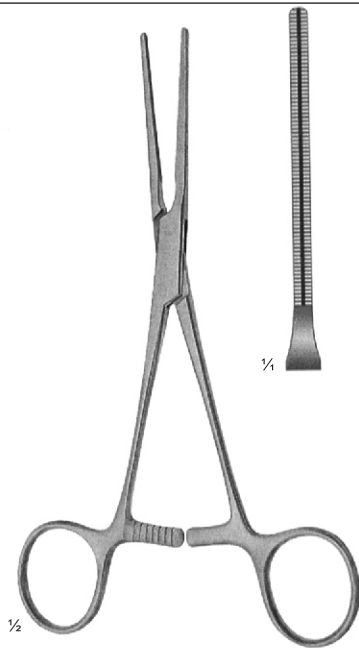

COOLEY
 31-736-17
 17 cm, 6¾"



COOLEY
 31-737-17
 17 cm, 6¾"



COOLEY
 31-745-01
 31-745-03

Multi-purpose clamps
 Mehrzweckklemmen
 Pizas-clamps de varias aplicaciones
 Pices-clamps universelles
 Pinze multiuso

Coarctation Clamps with Tothing COOLEY

Coarctationsklemmen mit COOLEY-Zahnung
 Pinzas-clamps para coarctación con dentado COOLEY
 Pince-clamps pour coarctation avec denture COOLEY
 Pinze per coartazione con dentatura COOLEY

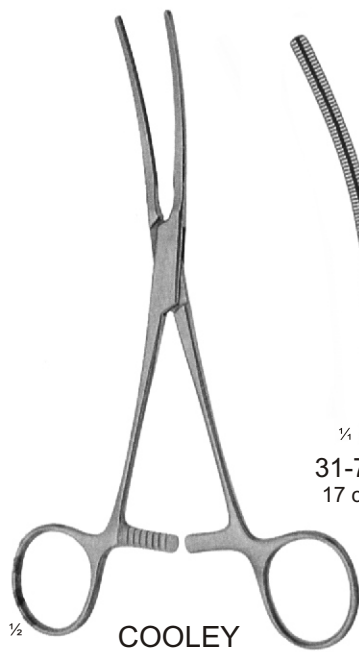
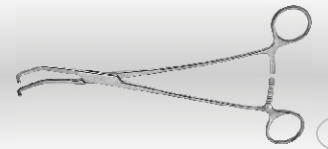

COOLEY
 31-750-01
 31-750-02

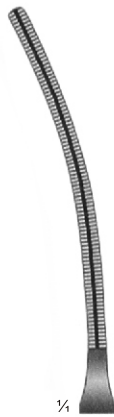

31-750-01
 17 cm, 6 $\frac{3}{4}$ "



31-750-02
 17 cm, 6 $\frac{3}{4}$ "



COOLEY
 31-751-17
 17 cm, 6 $\frac{3}{4}$ "

Peripheral vascular clamp
 Peripheralklemme
 Pinza-clamp para vasos periféricos
 Pince-clamp périphérique
 Pinza per vasi periferici

1/4

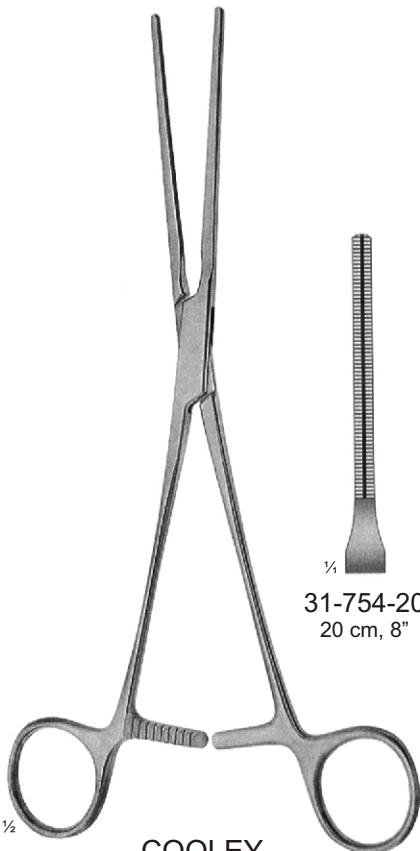

COOLEY
 31-754-20
 31-754-23

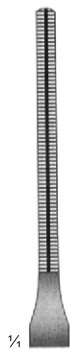

31-754-20
 20 cm, 8"

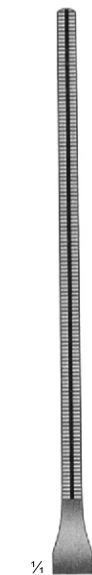

31-754-23
 23 cm, 9"



COOLEY
 31-755-19
 31-755-22

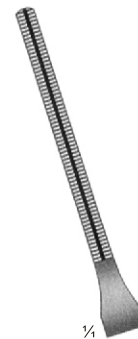

31-755-19
 19 cm, 7 $\frac{1}{2}$ "

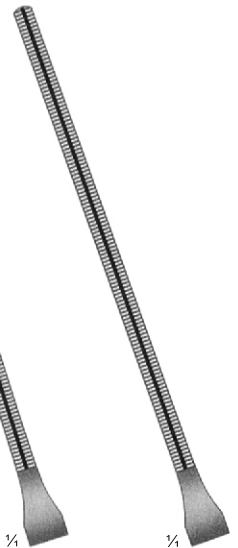

31-755-22
 22 cm, 8 $\frac{3}{4}$ "

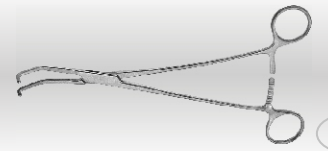

31-767-21
21 cm, 8¹/₄"

31-769-27
27 cm, 10³/₄"

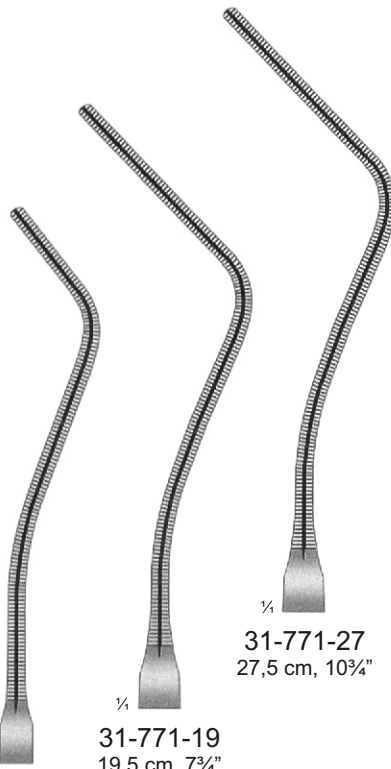

31-771-18
18,5 cm, 7¹/₄"

31-771-19
19,5 cm, 7³/₄"

31-771-27
27,5 cm, 10³/₄"

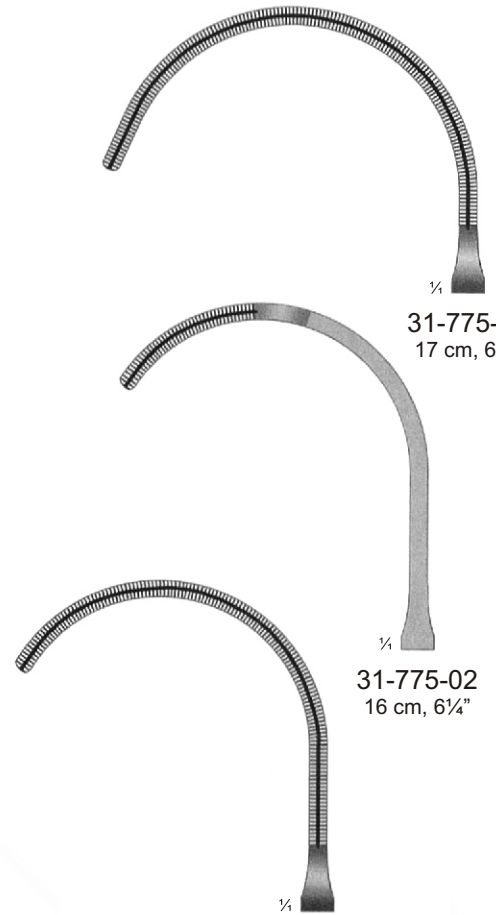

31-775-03
17 cm, 6³/₄"

31-775-02
16 cm, 6¹/₄"

31-775-01
16 cm, 6¹/₄"

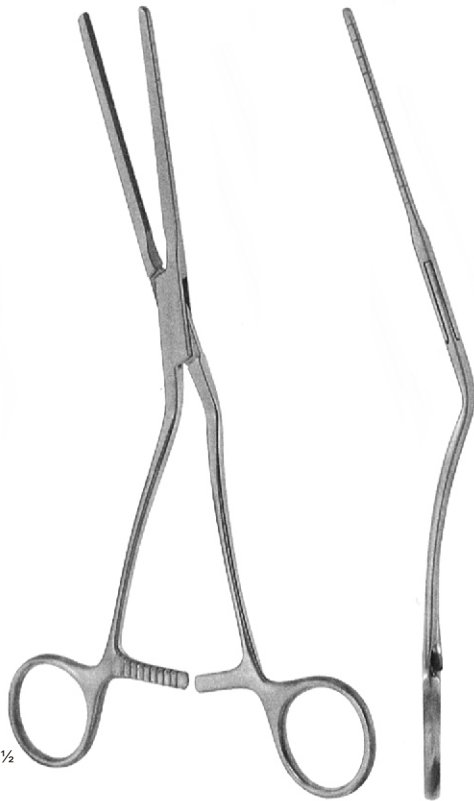

COOLEY
31-767-21
31-769-27

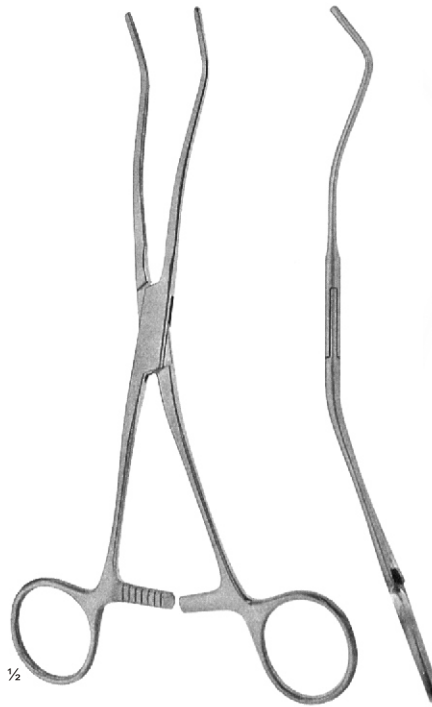

COOLEY
31-771-18
31-771-27



COOLEY
31-775-01
31-775-03

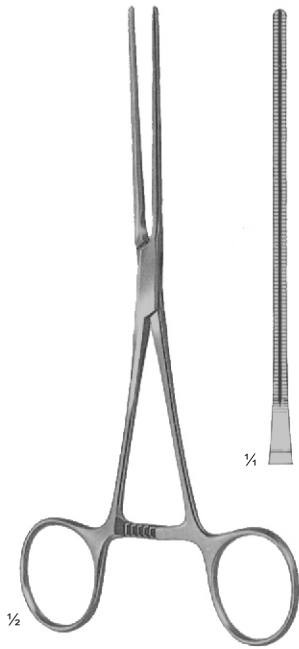
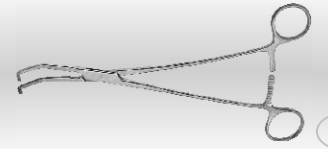

31-776-01
16.5 cm, 6½"

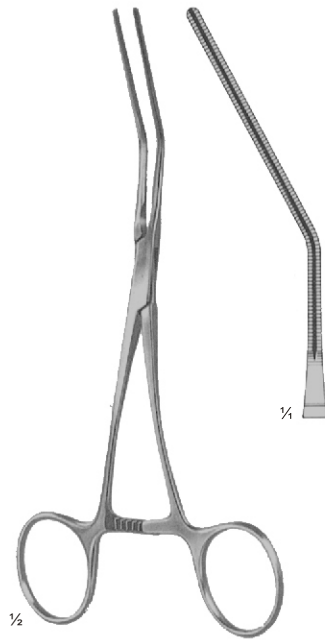

31-776-02
16 cm, 6¼"

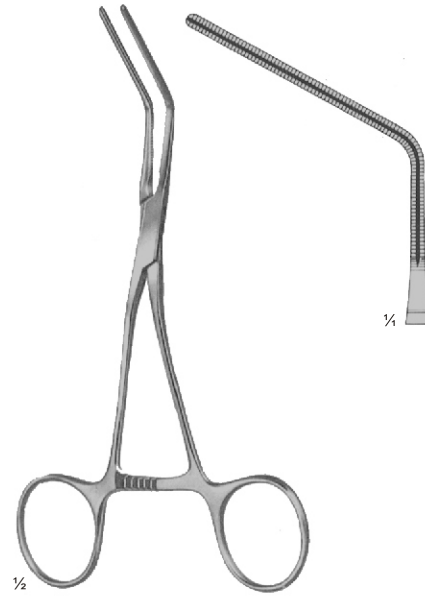

31-776-03
15 cm, 6"



31-776-04
15 cm, 6"

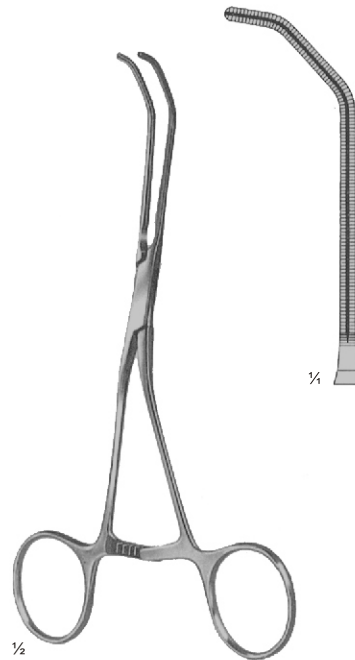

31-776-05
15.5 cm, 6"

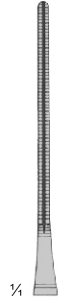
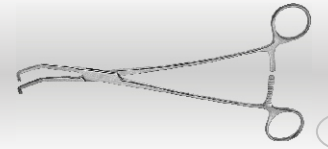

31-780-01
14 cm, 5½"

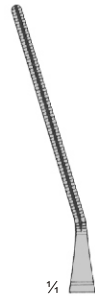

31-781-01
14 cm, 5½"



31-781-02
14 cm, 5½"

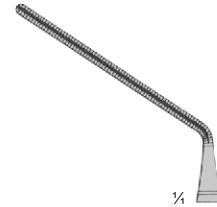

31-781-03
13 cm, 5"



31-781-04
14 cm, 5½"

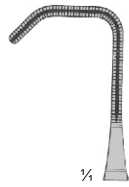

31-781-05
13 cm, 5"

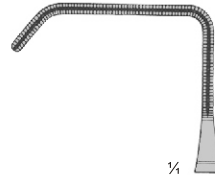

31-781-06
13 cm, 5"



31-781-07
14 cm, 5½"



31-781-08
13.5 cm, 5½"



31-780-01
31-781-08

Anastomosis clamps with Toothing COOLEY

Anastomosenklemmen mit COOLEY-Zahnung
 Pinzas-clamps para anastomosis con dentado COOLEY
 Pincas-clamps à anastomose avec denture COOLEY
 Pinze per anastomosi con dentatura COOLEY

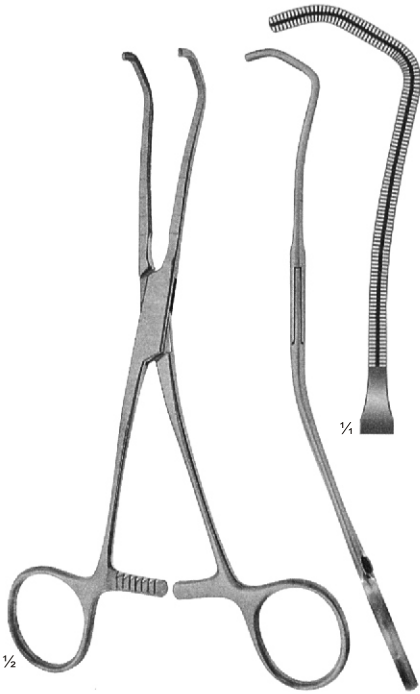
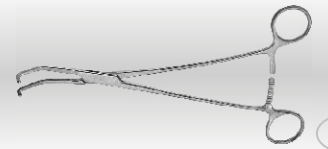

COOLEY
 31-801-17
 17 cm, 6¾"



COOLEY-REYNOLDS
 31-803-01
 31-803-04

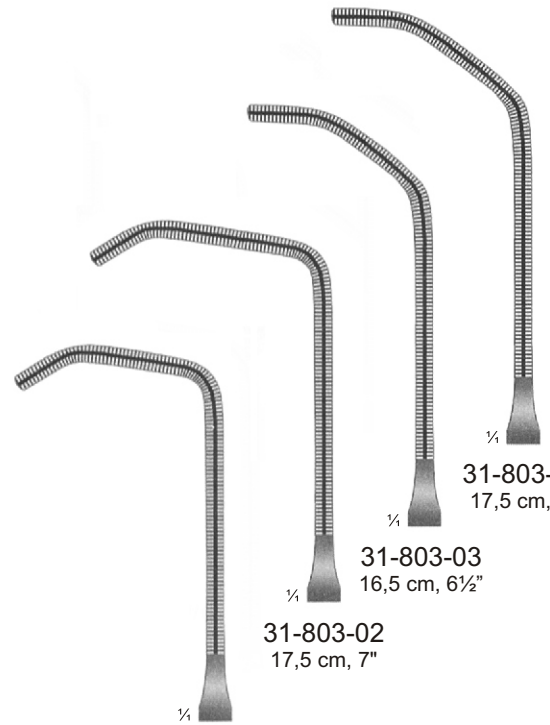

31-803-01
 16,5 cm, 6½"

31-803-02
 17,5 cm, 7"

31-803-03
 16,5 cm, 6½"

31-803-04
 17,5 cm, 7"

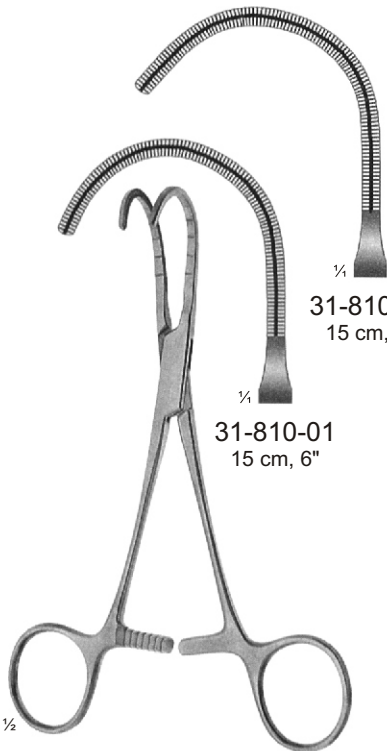

31-810-01
 15 cm, 6"

31-810-02
 15 cm, 6"

COOLEY-BECK
 31-810-01
 31-810-02



COOLEY-DERRA
 31-831-01
 31-831-03



31-831-01
 16,5 cm, 6½"

31-831-02
 16,5 cm, 6½"

31-831-03
 17 cm, 6¾"

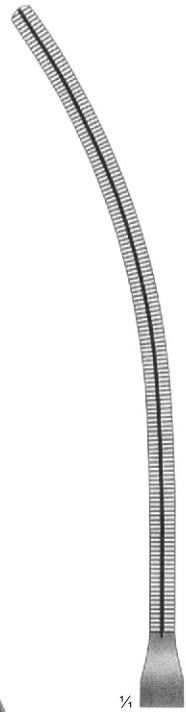
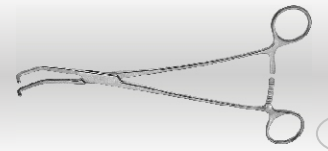

Aortic aneurysm clamp

Aorta-Aneurysmaklemme
 Pinza-clamp para aneurisma de aorta
 Pince-clamp pour anévrisme de l'aorte
 Pinza per l'aneurisma dell'aorta



COOLEY
 31-790-26
 26 cm, 10 $\frac{1}{4}$ "

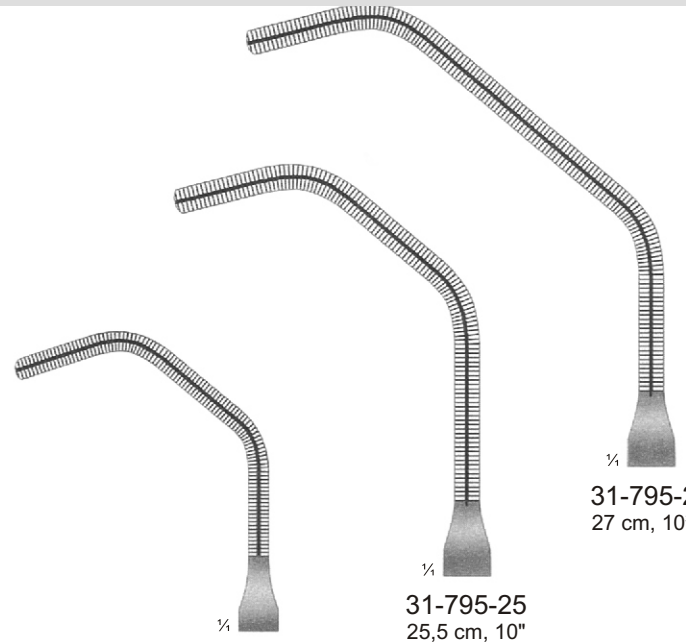

31-795-19
 19 cm, 7 $\frac{1}{2}$ "

31-795-25
 25,5 cm, 10"

31-795-27
 27 cm, 10 $\frac{3}{4}$ "

Tangential occlusion clamps

Gefäßklemmen für Tangential-Verschluss
 Pinzas-clamps para oclusión tangencial
 Pincas-clamps pour occlusion tangentielle
 Pinze per occlusione tangenziale

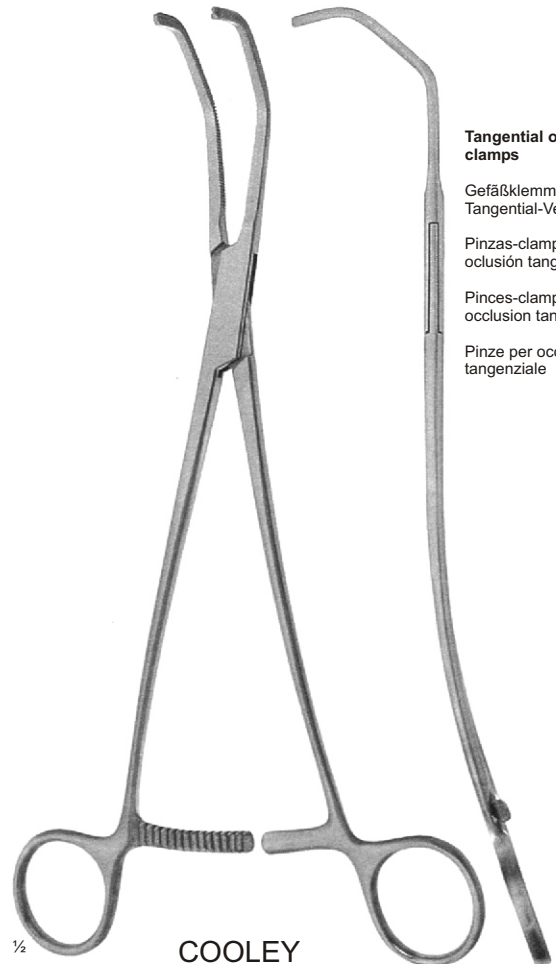

COOLEY
 31-795-19
 31-795-27

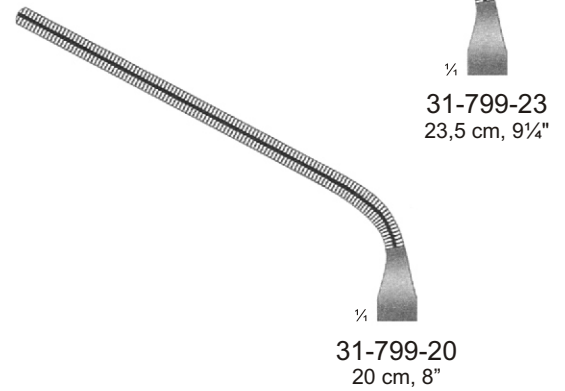
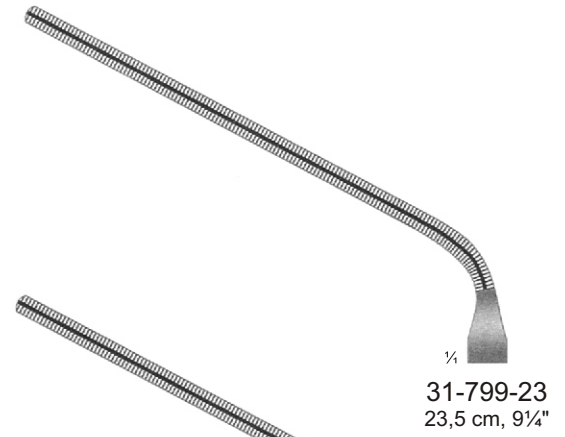
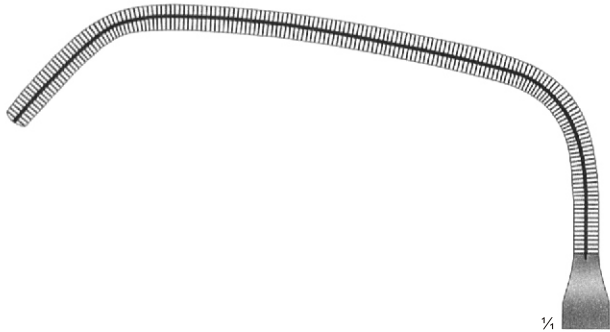
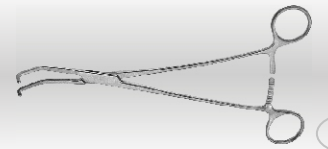

COOLEY
31-797-25
25 cm, 10"

Aortic clamp
 Aortaklemme
 Pinza-clamp para aorta
 Pince-clamp pour aorte
 Pinza per aorta



COOLEY
31-799-20
31-799-23

Multi-purpose clamps
 Mehrzweckklemmen
 Pinzas-clamps de varias aplicaciones
 Pincas-clamps universelles
 Pinze multiuso

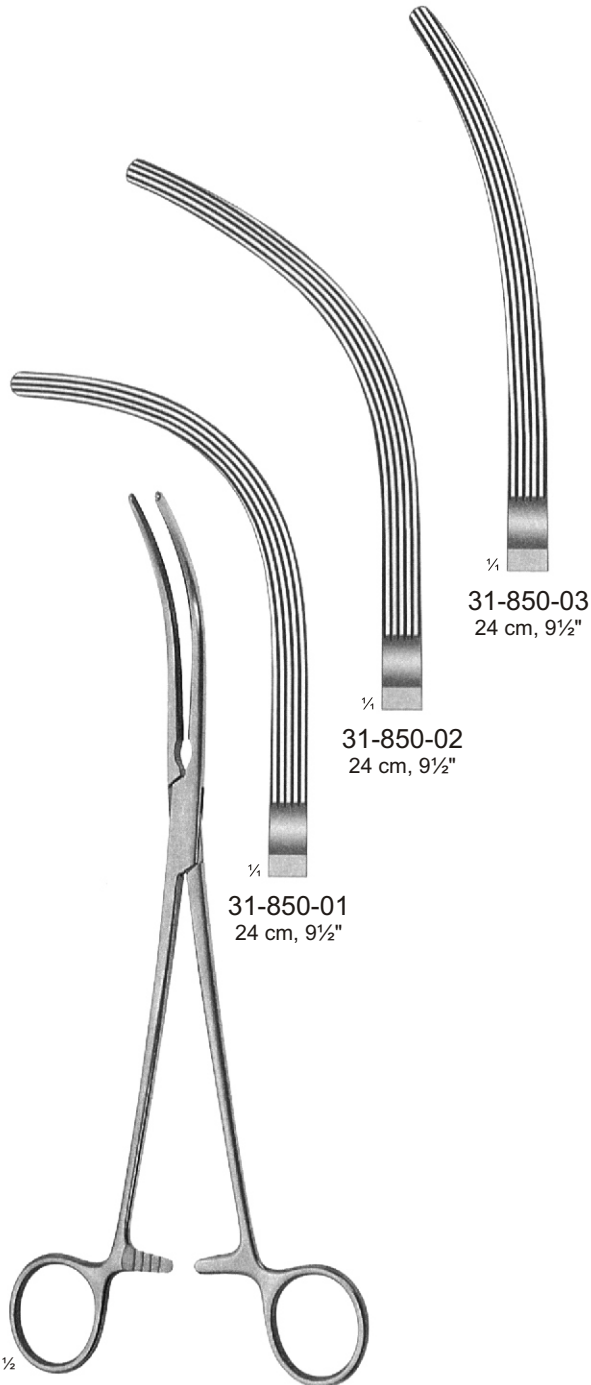
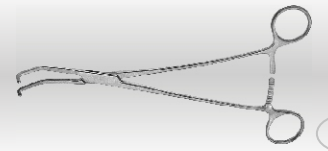

CRAFOORD
 31-850-01
 31-850-03

Auricle clamps
 Aurikerklemmen
 Pinzas para la auricula atril
 Pincès-clamps auriculaires
 Pinze ventricolari

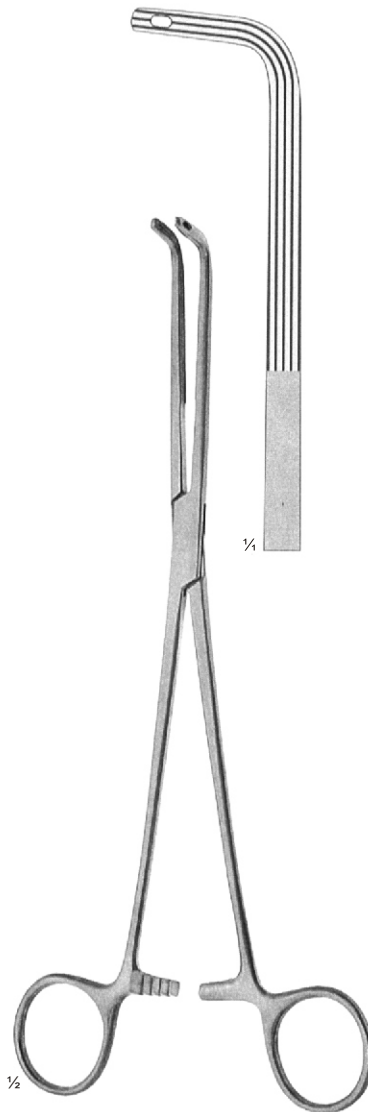

FINOCCHIETTO
 31-856-24
 24 cm, 9½"

Thoracic and ligature forceps
 Thorax- und Ligaturklemme
 Pinza de torácica y ligadura
 Pinçe thoracique et pour ligatures
 Pinza per torace e legature

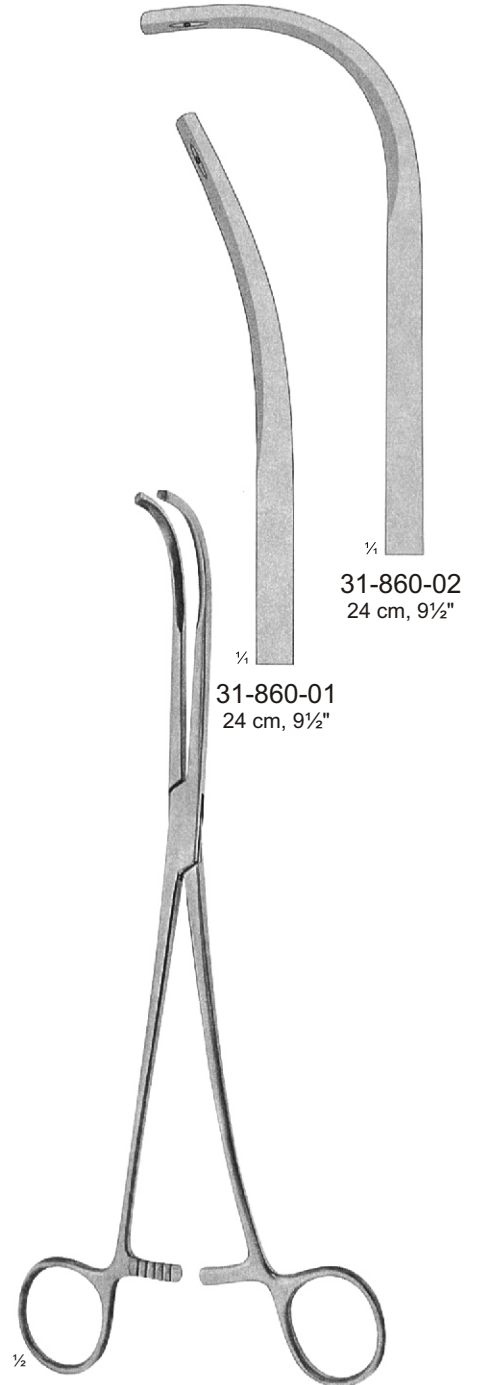

SEMEB
 31-860-01
 31-860-02

Dissecting and Ligature Forceps
 Präparier- und Ligaturklemmen
 Pinzas de disección y ligaduras
 Pincès à disséquer et à ligatures
 Pinze per dissezione e legature

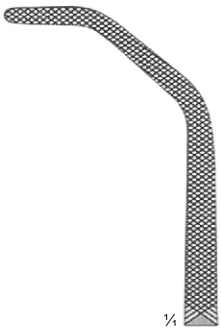
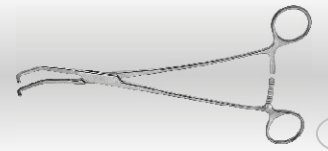

¼

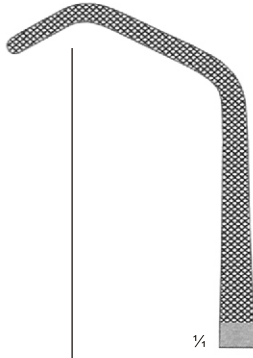

¼

31-910-01
20,5 cm, 8"

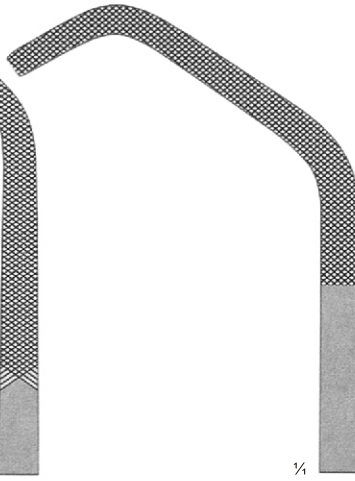

¼

31-910-02
27,5 cm, 10¾"

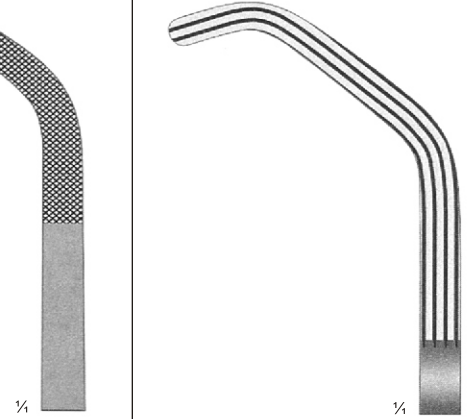

¼

31-910-03
24 cm, 9¼"

Bronchus Forceps
 Bronchusklemmen
 Pinzas-clamps
 Pincas-clamps à bronches
 Pinze per legature



½

BABY-SATINSKY
31-900-16
16 cm, 6¼"



½

SATINSKY
31-910-01
31-910-03

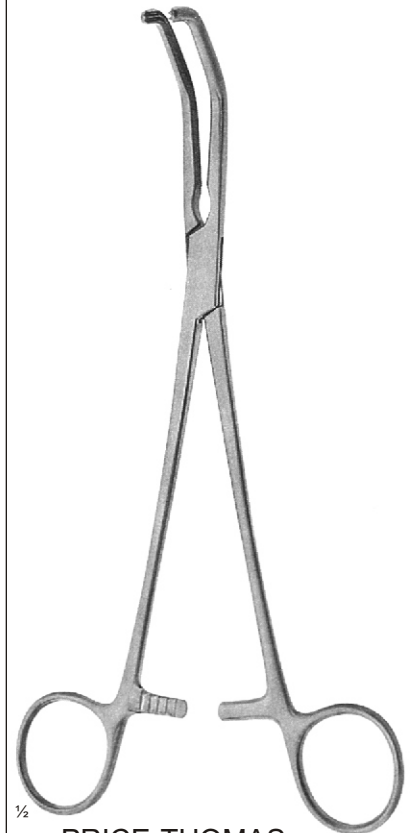

½

PRICE-THOMAS
31-920-22
22 cm, 8¾"

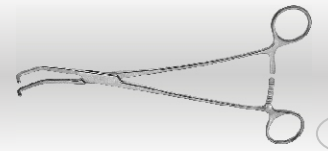

31-931-01 31-931-02
 22 cm, 8³/₄" 22 cm, 8³/₄"

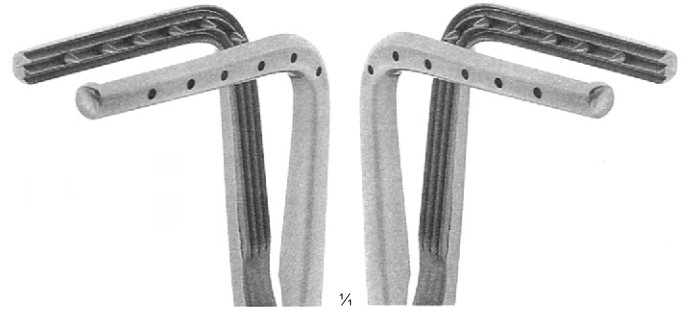

31-735-01 31-735-02
 22,5 cm, 9" 22,5 cm, 9"



1/2

PRICE-THOMAS

31-931-01
 31-931-02

Jaw with pins
 Mit Stiften im Maul
 Con dientes
 Avec dents
 Con denti



1/2

SAROT

31-935-01
 31-935-02

Jaw with pins
 Mit Stiften im Maul
 Con dientes
 Avec dents
 Con denti

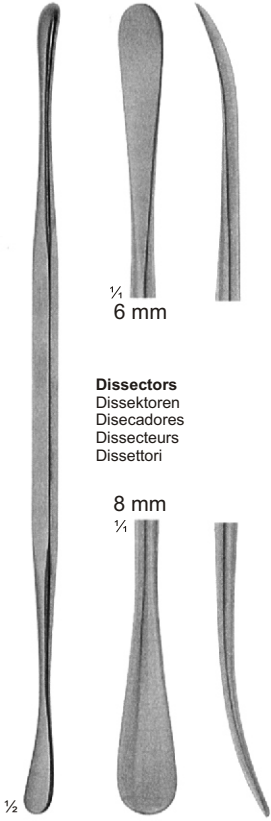

¼
6 mm

Dissectors
Dissektoren
Disecadores
Dissecteurs
Dissettori

8 mm
¼

ALDERDYCE
33-100-21
21 cm 8¼"

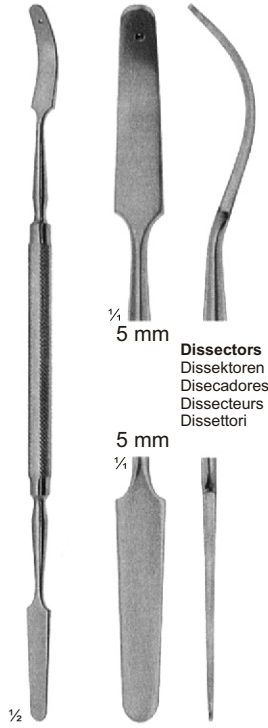

¼
5 mm

Dissectors
Dissektoren
Disecadores
Dissecteurs
Dissettori

5 mm
¼

McDONALD
33-102-19
19 cm 7½"



¼

33-104-01
17 cm, 6¾"
4 mm

Elevators
Elevatorien
Elevadores
Elévateurs
Elevatori

WILLIGER
33-104-01
33-105-03



¼

33-104-02
17 cm, 6¾"
5,5 mm



¼

33-105-03
16 cm, 6¼"
5,5 mm

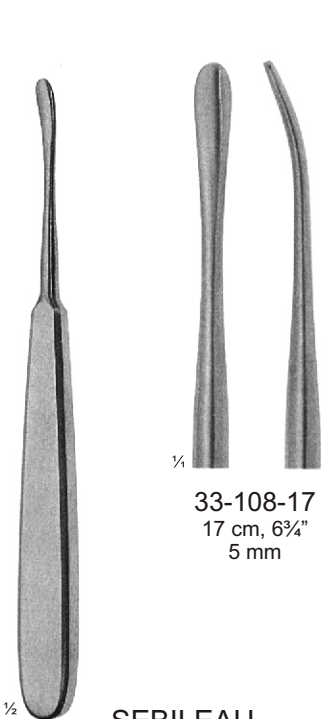

¼

33-108-17
17 cm, 6¾"
5 mm

SEBILEAU
33-108-17
33-108-19

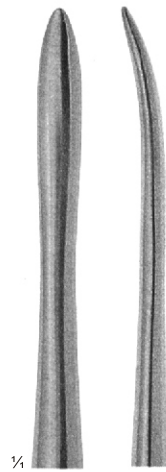

¼

33-108-19
19,5 cm, 7¾"
6 mm



¼

LANGENBECK
33-112-01
33-112-02



¼

33-112-01
20 cm, 8"
8 mm



¼

33-112-02
20 cm, 8"
10 mm



1/4
 10 mm

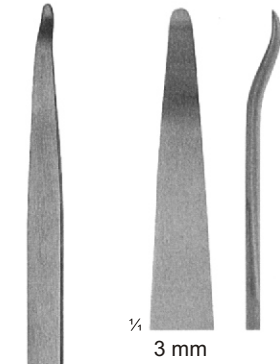

1/4
 3 mm

33-118-14
 14,5 cm, 5 3/4"

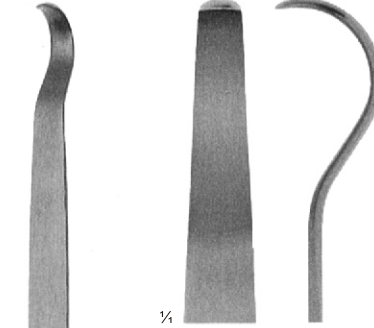

1/4
 33-120-01
 14 cm, 5 1/4"
 6 mm

33-120-01
 33-120-02

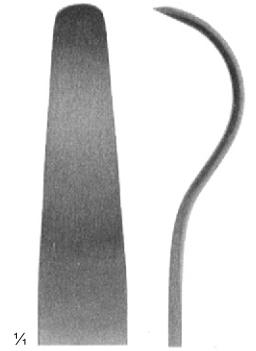

1/4
 33-120-02
 14 cm, 5 1/4"
 7 mm



1/2

LANGENBECK
 33-116-23
 23 cm, 9"

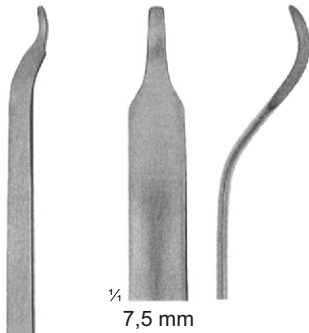

1/4
 7,5 mm

BUCK-GRAMCKO
 33-122-16
 16 cm, 6 1/4"



1/4
 33-124-01
 16 cm, 6 1/4"
 6 mm

MINI-HOHMANN
 33-124-01
 33-124-02

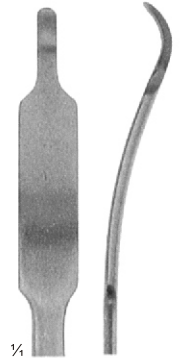

1/4
 33-124-02
 16 cm, 6 1/4"
 8 mm